

MITSUBISHI HEAVY INDUSTRIES LTD. PACKAGED AIR CONDITIONER

- Ceiling cassette –4 way– (FDT)
- Ceiling cassette –4 way Compact (600×600mm)– (FDTC)
- Duct connected –High static pressure– (FDU, FDUS)
- Duct connected –Middle static pressure– (FDUM)
- Ceiling Suspended (FDE)
- Floor Standing (FDF)

USER'S MANUAL **ENGLISH**

MANUEL DE L'UTILISATEUR **FRANÇAIS**

ANWENDERHANDBUCH **DEUTSCH**

ISTRUZIONI PER L'USO **ITALIANO**

MANUAL DEL PROPIETARIO **ESPAÑOL**

GEBRUIKERSHANDLEIDING **NEDERLANDS**

MANUAL DO UTILIZADOR **PORTUGUÊS**

ΟΔΗΓΙΕΣ ΧΡΗΣΗΣ **ΕΛΛΗΝΙΚΑ**

РУКОВОДСТВО ПО ЭКСПЛУАТАЦИИ **РУССКИЙ**

KULLANIM KILAVUZU **TÜRKÇE**



<WIRED REMOTE CONTROL>
RC-E5



<eco touch REMOTE CONTROL>
RC-EX series ※

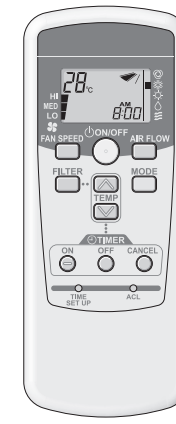

<WIRELESS REMOTE CONTROL>

Please refer to the manual provided with eco touch REMOTE CONTROL

Si vous plaît se référer à la documentation fournie avec la eco touch télécommande

Bitte beachten Sie die Dokumentation, die mit der eco touch Fernbedienung kam

※ Si prega di fare riferimento alla documentazione fornita con il eco touch telecomando

※ Por favor, consulte la documentación que viene con el eco touch mando a distancia

※ Raadpleeg de documentatie die bij de eco touch afstandsbediening

※ Por favor, consulte a documentação que veio com o eco touch controle remoto

※ Ανατρέξτε στην τεκμηρίωση που συνοδεύει το eco touch τηλεχειριστήριο

※ Пожалуйста, обратитесь к документации, поставляемой с eco touch дистанционным управлением

※ eco touch uzaktan kumanda ile birlikte gelen belgeleere bakın



This air-conditioner complies with EMC Directive 2004/108/EC (replaced by 2014/30/EU on 20/4/2016), LV Directive 2006/95/EC (replaced by 2014/35/EU on 20/4/2016). CE marking is applicable to the area of 50 Hz power supply.

Ce climatiseur est conforme à la directive CEM 2004/108/CE (remplacée par la directive 2014/30/UE le 20/04/2016) et à la directive basse tension 2006/95/CE (remplacée par la directive 2014/35/UE le 20/04/2016). La marque CE s'applique aux régions alimentées en courant de 50 Hz.

Dieses Klimagerät erfüllt die Richtlinien zur elektromagnetischen Verträglichkeit 2004/108/EC (ersetzt durch 2014/30/EU am 20/4/2016) und die Niederspannungsrichtlinien 2006/95/EC (ersetzt durch 2014/35/EU am 20/4/2016). Die CE-Markie gilt für Bereiche mit einer Netzstromversorgung von 50 Hz.

Questo condizionatore d'aria è conforme alla Direttiva EMC 2004/108/CE (sostituita dalla Direttiva 2014/30/UE il 20/4/2016) e alla Direttiva LV 2006/95/CE (sostituita dalla Direttiva 2014/35/UE il 20/4/2016). Il marchio CE è applicabile alla fascia di alimentazione 50 Hz.

Este equipo de aire acondicionado cumple con la Directiva de Compatibilidad Electromagnética: 2004/108/CE (reemplazada por la Directiva 2014/30/EU el 20/4/2016), y con la Directiva de Baja Tensión 2006/95/CE (reemplazada por la Directiva 2014/35/EU el 20/4/2016). La indicación CE sólo corresponde al área de suministro eléctrico de 50 Hz.

Deze airconditioner voldoet aan EMC-Richtlijn 2004/108/EC (vervangen door 2014/30/EU op 20/4/2016), LV-Richtlijn 2006/95/EC (vervangen door 2014/35/EU op 20/4/2016). CE-markering is van toepassing op het gebied met een netstroom van 50 Hz.

Este aparelho de ar condicionado está em conformidade com a Directiva EMC 2004/108/CE (substituída pela 2014/30/UE a 20/4/2016) e a Directiva LV 2006/95/CE (substituída pela 2014/35/UE a 20/4/2016). A marca CE aplica-se à zona de fornecimento de energia a 50 Hz.

Το συγκεκριμένο κλιματιστικό συμμορφώνεται προς την Οδηγία 2004/108/ΕΚ περί ηλεκτρομαγνητικής συμβατότητας (η οποία αντικαταστάθηκε από την Οδηγία 2014/30/ΕΕ στις 20/4/2016) και προς την οδηγία 2006/95/ΕΚ περί χαμηλής τάσης (η οποία αντικαταστάθηκε από την Οδηγία 2014/35/ΕΕ στις 20/4/2016). Το σήμα CE ισχύει μόνον σε περιοχές όπου η τροφοδοσία είναι 50 Hz.

Thank you very much for your purchase of this packaged air conditioning system produced by Mitsubishi Heavy Industries. Please read through this manual before using the product and use the product appropriately according to the instructions in the manual. After you have read the manual, store it with the warranty certificate in a safe place. It will help you when you have questions or problems.

Do not vent R410A into the atmosphere: R410A is a fluorinated greenhouse gas specified in the Kyoto Protocol and its Global Warming Potential (GWP) is 1975.

The emission sound pressure level from each Indoor and Outdoor unit is under 70 dB(A).

- SAFETY PRECAUTIONS.....1
- HOW TO USE
- < WIRED REMOTE CONTROL >
- NAMES AND FUNCTIONS OF REMOTE CONTROL BUTTONS
- "WIRED REMOTE CONTROL".....4
- HOW TO OPERATE.....5
- HOW TO PERFORM THE TIMER OPERATION.....5
- THE SELECTION OF TIMER MODE.....5
- SETTING THE TIME.....6
- SLEEP TIMER MODE.....6
- OFF TIMER MODE.....6
- ON TIMER MODE.....7
- WEEKLY TIMER MODE.....7
- TIMER CANCELLATION MODE.....10
- HOW TO OPERATE IN SILENT MODE.....10
- HOW TO ADJUST THE LOUVER.....11
- HOW TO SET THE AIRFLOW DIRECTION.....11
- HOW TO OPERATE VENTILATION.....12
- FOR COMFORTABLE USE.....12
- INSPECTION DISPLAY, FILTER SIGN, AIR CONDITIONER NUMBER, STANDBY AND ROOM TEMPERATURE DISPLAY.....13
- < WIRELESS REMOTE CONTROL >
- NAMES AND FUNCTIONS OF REMOTE CONTROL BUTTONS
- WIRELESS REMOTE CONTROL.....13
- HOW TO OPERATE.....14
- CURRENT TIME SETTING PROCEDURE.....14
- ON – TIMER OPERATION.....14
- OFF – TIMER OPERATION.....14
- PROGRAM TIMER OPERATION.....14
- HOW TO ADJUST THE LOUVER.....15
- FOR COMFORTABLE USE.....15
- CHECK INDICATION, FILTER SIGN.....15
- BACKUP BUTTON.....16
- FOR SMART USE
- HOW TO MAINTAIN.....16
- TROUBLE SHOOTING.....17
- NOTICE
- PREPARATION OF HEATING.....18
- AUTO RESTART.....18
- SETTING TO DISABLE BUTTON OPERATION.....18
- INSTALLATION, RELOCATION, AND INSPECTION MAINTENANCE.....18
- OPERATION RANGE.....18
- MAINTENANCE AND INSPECTION GUIDELINE OF MAIN PARTS OF PACKAGED AIR CONDITIONER.....19

SAFETY PRECAUTIONS

■ Please read these “SAFETY PRECAUTIONS” before starting to use this product and use the product appropriately according to the instructions.

■ The precautions provided here are classified into “⚠ DANGER” and “⚠ CAUTION”. The “⚠ DANGER” sections describe potentially hazardous situations that may lead to serious outcomes such as death and serious injuries if the product is mishandled. Note, however, that depending on the situation, the items listed in the “⚠ CAUTION” sections do also have the potential of causing serious outcomes. Both warnings and cautions provide you important information related to safety ; please make sure to observe them.

■ The symbols used throughout the main text of this manual have the following meaning.

⚠ ⚠ marks mean danger, alarm, and caution. The specified prohibited item is described in the triangle. The left mark means “Shock hazard

alarm”.

⊘ ○ marks mean prohibited items. The specified prohibited item is described in the circle or in the vicinage.

⚡ ● marks mean compulsory action or instruction. The specified prohibited item is described in the circle. The left mark means “Earth is needed”.

■ After you have read the manual, always store it where other users can refer to at any time. If a new owner takes over the system, make sure to pass this manual.

INSTALLATION PRECAUTIONS

⚠ DANGER

Make sure to have the installation done by your dealer or a specialist. !

If you install by yourself and the unit is not properly installed, water leakage, electric shock, fire and injuries caused by the drop of the unit may occur.

The preventive measures that the density of leaked refrigerant does not exceed the limit is necessary in case of installing the unit in a small room.

The leakage of refrigerant may cause oxygen deficiency accident. Consult your dealer for the measures.

⚠ CAUTION

Make sure to perform grounding work.

Do not connect grounding wire to any gas pipe, water pipe, conductor rods or telephones. Incomplete grounding may cause electric shock through leakage of electricity.

Make sure to mount a leakage breaker.

Otherwise electric shock may occur. Please consult your dealer or a specialist for the mounting.

Do not mount where flammable gas leakage can happen.

If leaked gas stagnates in the unit, the gas may cause fire.

Make sure to layout the drain pipe so that the water is completely drained.

Otherwise, water may leak and wet household goods.

OPERATION PRECAUTIONS

⚠ DANGER

This appliance can be used by children aged from 8 years and above and persons with reduced physical, sensory or mental capabilities or lack of experience and knowledge if they have been given supervision or instruction concerning use of the appliance in a safe way and understand the hazards involved.

Children shall not play with the appliance.

Cleaning and user maintenance shall not be made by children without supervision.

Do not expose yourself directly to cooled air flow for a long time or cool too much.

It may be cause of deconditioning or health disorder.

Do not insert fingers or sticks into the air inlet or outlet grilles.

It may cause injuries because of the fan rotating at high speed.

If the unit has been submerged under water due to a natural disaster such as flood or typhoon, consult your dealer before using it again.

If you use it as it stands, it may lead to failure, electric shock or fire.

If any abnormal symptom (scorched flavor etc.) is found, cut off the power and stop the operation.

Then consult your dealer.

If you use it as it stands, it may lead to failure, electric shock or fire.

One of the causes of poor cooling or poor heating may be refrigerant leakage. Please consult your dealer.

If the repair requires additional refrigerant, determine the service with the service staff. The refrigerant of air conditioner is not toxic. Normally the refrigerant does not leak. But if it leaks and contacts fire such as fan heater, space heater or cooking heater, it may produce toxic chemicals.

Do not insert fingers or sticks even if air blower does not operate.

It may suddenly operate and cause injuries.

⚠ CAUTION

Do not use for particular purpose such as the storage of food, animals and plants, precision apparatus and arts etc.

Storage goods may degrade.

Do not operate the button with wet hand.

It may cause electric shock.

When a burning appliance is used together with the unit, ventilate frequently.

If ventilation is not sufficient, it may cause oxygen deficiency accident.

Do not place a burning appliance where the airflow from the unit is directly blown.

It may cause the imperfect combustion of the equipment.

Make sure that the unit installation foundation is not damaged due to long-term use.

If it is left to stand, the unit may fall down causing injury.

Do not wash the unit with water, nor place a vase with water on the unit.

It may cause electric shock or ignition.

Do not install the unit where the airflow is directly blown to animals and plants. 

They may suffer from adverse effect.

Before cleaning, make sure to stop operation and cut off the power. 

The fan inside rotates at high speeds.

Make sure to use proper size of fuse. 

Using steel wire or copper wire may lead to failure or fire.

Do not store a flammable spray etc. near the unit, nor blow directly to the unit. 

It may lead to fire.

Before maintenance, make sure to stop operation and cut off the power. 

The fan inside rotates at high speeds.

When the unit isn't used for a long-term, cut off the power. 

The accumulation of dirt may lead to heat generation or fire. But, before resuming the operation, turn on the unit for six hours beforehand to save harmless.

Do not place any other electric appliances or household goods below or around the air conditioner. 

Dripping from the unit may lead to failure or contamination.

Do not touch the aluminum fin. 

Otherwise it may lead to injuries.

Do not clean the inside of the indoor unit by yourself. Make sure to consult your dealer or user inquiry counter specified by our company. 

If you select incorrect detergent or improper method, resin parts may be damaged and lead to water leakage. If the detergent is dropped on the electric component or motor, it may lead to failure, smoking or ignition.

Do not place objects on the outdoor unit, nor mount on it. 

It may lead to injuries resulting from dropping or falling.

During the operation or maintenance, do not use an unstable footrest. 

It may lead to injuries resulting from falling.

Be careful so that the dust does not get into your eyes when removing the air filter. 

Do not operate the air conditioner while the air filter is removed. 

Piled up dust may lead to malfunction.

During thunderstorm, stop the operation and turn off the switch. 

A lightning strike may lead to failure.

After several seasons of operating, inspections and maintenances are required except routine care and cleaning. 

Accumulated dirt or dust inside the indoor unit may cause odor, water leakage through the clogging of water discharging pipe for dehumidification. Specialized information and skills are required for inspections and maintenances. Therefore contact your dealer.

Do not place any object around the outdoor unit, nor allow fallen leaves to pile up. 

Fallen leaves may induce insects and worms in them, and they may lead to failure, ignition or smoking by touching electric components.

Do not use with inlet/outlet grilles or other panel removed. 

Otherwise, it may lead to injuries.

Do not operate or stop the unit by using the power supply switch. 

It may lead to fire or water leakage.

If auto restart is set effectively, the fan may rotate suddenly causing injuries.

Do not touch blowout port when the swing louver moves. 

Otherwise, it may lead to injuries.

Do not strain the remote control cord. 

A part of core wire may be cut off causing electric leakage.

Do not use water heater etc. near the indoor unit or remote control. 

If a Vapor-generating appliance is used near them, it may lead to water drop causing electric leakage or short circuit.

Do not use the unit where powder or fiber is floating. 

Fine powder or fiber passing through the air filter may stagnate inside the unit and lead to electric leak or short circuit.

Do not place objects under the unit which must avoid being exposed to water. 

Over 80 percent humidity or the clogging of drain pipe may damage them through dew dropping.

PRECAUTIONS FOR RELOCATION OR REPAIRING

CAUTION

Never perform any modification. Contact your dealer for repairing.

Improper repairing may lead to water leakage, electric shock or fire. Normally the refrigerant does not leak. But if it leaks and contacts fire such as fan heater, space heater or cooking heater, it may produce toxic chemicals. When repairing refrigerant leakage, determine the service with the service staff that the repair has been finished without fault.

If it is required to relocation and reinstall the unit, consult your dealer or a specialist.

Improper installation of air conditioning unit may cause water leakage, electric shock and/or fire.

Before repairing or checking indoor unit, be sure to turn off “Indoor unit power supply breaker”.

It can result in electric shock or injury due to rotation of indoor unit fan if you perform check or repair with the “Indoor unit power supply breaker” turned on.

Place the panels removed for repairing or checking on the stable spot.

Otherwise, dropping or falling may lead to injury.

PRECAUTIONS FOR WASTE DISPOSAL



Your Air Conditioning product may be marked with this symbol. It means that waste electrical and electronic equipment (WEEE as in directive 2012/19/EU) should not be mixed with general household waste. Air conditioners should be treated at an authorized treatment facility for re-use, recycling and recovery and not be disposed of in the municipal waste stream. Please contact the installer or local authority for more information.

HOW TO USE < WIRED REMOTE CONTROL >

NAMES AND FUNCTIONS OF REMOTE CONTROL BUTTONS (WIRED REMOTE CONTROL)

Wired remote control • The figure below shows the remote control with the cover opened. Note that the items in the liquid crystal display (LCD) area are shown for explanation purpose.
Pull the cover downwards to open.

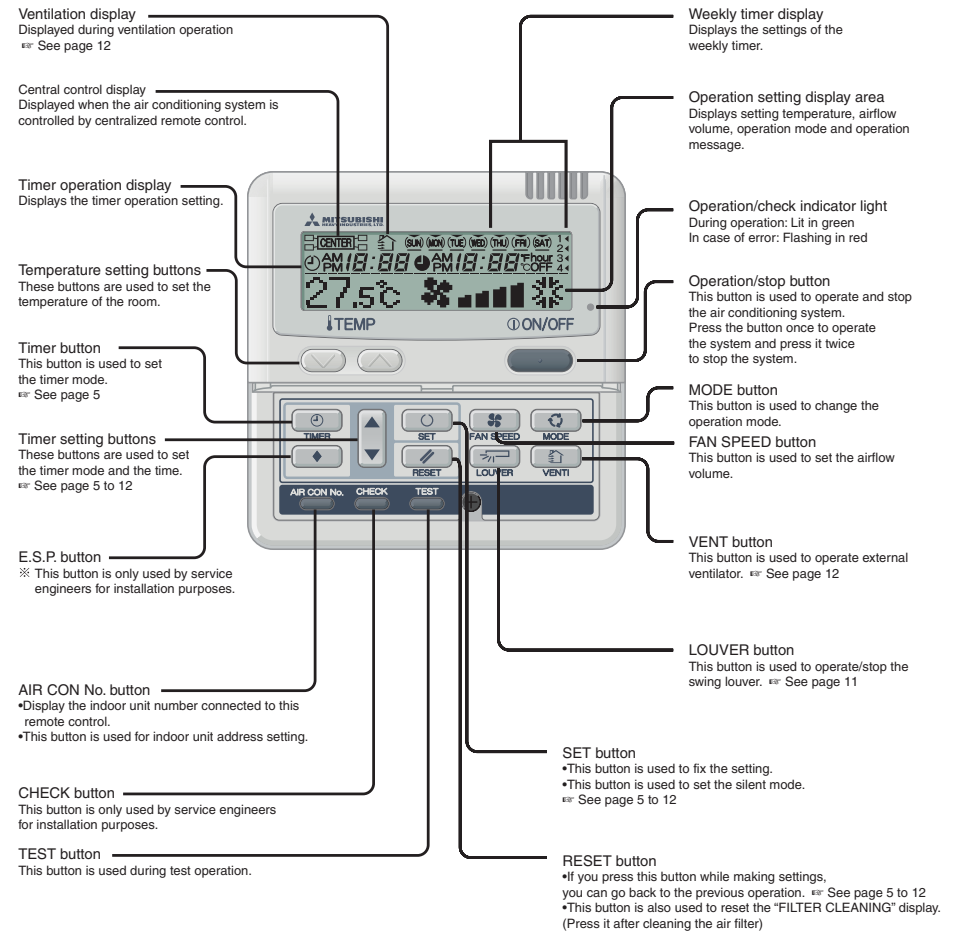

HOW TO OPERATE

< WIRED REMOTE CONTROL >

ATTENTION • In order to protect both indoor/outdoor air conditioners, keep the power supply on for six hours before initial operation. (The crank case heater is energized in order to heat up the compressor.) Do not turn off the power supply. (Power is distributed to the crankcase heater, even if the compressor is stopped. This keeps the compressor warm, and prevents failures caused by accumulation of liquid refrigerant.)

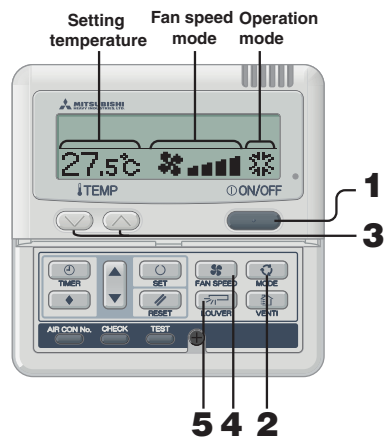

Operation mode

DRY	
COOL	
FAN	
HEAT	
AUTO	

Guideline for room temperature setting

- COOL26 to 28°C
- DRY21 to 24°C
- HEAT22 to 24°C
- FAN.....Setting unnecessary

• The settings of operation change, temperature and air flow volume adjustment can be changed even when the air conditioner is stopped. When a button is pressed while the operation is stopped, the corresponding display is turned on and you can change the setting. The display lights for three seconds after changing the setting, and then turns off automatically.

1 Press ON/OFF button.

The unit starts operating.

2 Press MODE button.

The range of operation mode is displayed according to the model of indoor unit.

Every time the button is pressed, the display changes in the following order: dry → cool → fan → heat → auto. (EXAMPLE display for auto-operation enabled)

- With auto operation, heating and cooling is automatically changed depending on difference between the setting temperature and sucking room air temperature.

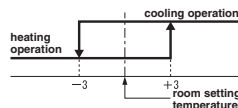

3 Press TEMP button.

Press or button to set the room temperature.

4 Press FAN SPEED button.

The range of fan speed modes is displayed according to the model of indoor unit.

- At 4-speed.....
- At 3-speed.....
- At 2-speed..... or
- At 1-speed.....The operation is invalid

at 4-speed
The unit operates with the maximum fan speed.

5 Press LOUVER button.

If the indoor unit is equipped with the auto swing function, press the LOUVER button once and current louver status is displayed.

If the indoor unit is not equipped with the auto swing function, the message "INVALID OPER" is displayed.

- **For the louver operation** See page 11 to 12
① Press LOUVER button, and change the display to
- **For the louver stopping** See page 11 to 12
① Press once while the louver is operating to display stop positions in order.
② Press the button once more at the preferred stop position to stop the louver at that position.
Effective stop position See page 11 to 12
For automatic operation:.....middle
For cooling/dehumidifying operation:.....Horizontal
For heating operation:.....downwards

Stop Press ON/OFF button

NOTICE

- There may be a case that "INVALID OPER" is displayed when any button mentioned in the above is pressed, but it is not a malfunction. In that case, the operation of the button is prohibited.
- When you start to operate the unit for the first time after turning the power supply on, the default settings are listed below. You can change them as you like.
Central control.....Turned off
Operation changeover.....With auto mode : auto cooling
Without auto mode : cooling
Set temperature23°C
Fan speed
Louver position.....Horizontal

HOW TO PERFORM THE TIMER OPERATION

< WIRED REMOTE CONTROL >

THE SELECTION OF TIMER MODE

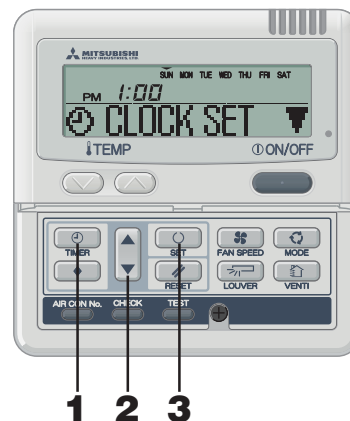

1 Press TIMER button.

The mode changes to timer mode. "Current day of the week" and "Current time" are displayed. [EXAMPLE] Sunday : 1 o'clock in the afternoon

Display area : [SUN MON TUE WED THU FRI SAT]
[PM 1:00]
[CLOCK SET] (lights)

2 Press or button.

By pressing or button, it is possible to choose the item to set.

- (set to current time)
- (Every operation stops after a certain period of time has elapsed.)
- (The unit stops operating at the setting time.)
- (The unit starts operating at the setting time.)
- (Timer set for each day of the week)
- (Cancel the timer setting)

If you press the RESET button, timer mode ends and return to original status.

3 Press SET button.

The selected timer mode is set.

For setting of each timer mode, see the following pages.

The possible combination of the timer function is mentioned in the following table.

Combination of modes that can be set together (○: possible x: impossible)

	Sleep timer	OFF timer	ON timer	Weekly timer
Sleep timer		x	○	x
OFF timer	x		○	x
ON timer	○	○		x
Weekly timer	x	x	x	

- If you select a combination of modes that cannot be set together and press the SET button, the message "INVALID OPER (invalid operation)" is displayed for 3 seconds and then the display returns to the one selected in step 2.

Functions of each timer operation

- **Sleep timer**
When the specified period of time elapses, operation stops.
10 settings are available, from "an hour later OFF" to "10 hours later OFF".
The unit will stop when the setting time is reached.
- **OFF timer**
The unit stops operating at the setting time.
It will operate one time per setting.
- **ON timer**
The unit starts to operate at the setting time. The temperature can be set together. It will operate one time per setting.
- **Weekly timer**
You can set up to four ON/OFF timers per day.
Once Weekly timer is set, it repeats every week.

NOTICE

- If you press ON/OFF button while timer mode is under setting, timer mode is canceled and the display will return to the original one. Note that the setting which has not completed is canceled.
- If you have set the ON timer mode and either the OFF timer or Sleep timer mode at the same time, the OFF timer (or Sleep timer) precedes the ON timer.
- If you press the Timer button and "INVALID OPER" is displayed, the button can not be operated because the button operation is disabled. If you want to make the button effective, consult your dealer.
- If you do not press any button for several minutes after pressing the Timer button, Timer mode ends and the display returns to the original one.
- When the weekly timer setting recovers from power failures, the setting data (four settings per day) remain stored, but holiday settings will automatically override the settings for each day.

SETTING THE TIME

Timer operation is performed based on the time of the clock which is set by the following steps. Make sure to set the time to the current time correctly.



1
•
3
•
2
•
5
•
4
•
6

- 1 Press TIMER button.**
The mode changes to timer mode.
"Current day of the week" and "Current time" are displayed.
Display area : [SUN MON TUE WED THU FRI SAT]
[PM 1:00]
 ▼
- 2 Press SET button.**
The display area shows : [SUN MON TUE WED THU FRI SAT]
(▼ flashes)
[PM 1:00] (current time)
 SET DAY]
- 3 Press ▲ or ▼ button.**
Place the "▼" mark above the day of the week to the current day.
Press ▲ and ▼ mark to move to the right and the left respectively.
If you press the RESET button, the remote control will return to the previous screen and display ▼.
- 4 Press SET button.**
The day of the week is fixed, and the flashing of ▼ mark stops and lights.
The "current time" value flashes, and SET TIMER is displayed.
- 5 Press ▲ or ▼ button.**
Set to the current time.
If you press the RESET button, the display is returned to the one in step 1.
- 6 Press SET button.**
The flashing for time display stops and lights, and CLOCK SET OK is displayed to show that the current time is set.
Two seconds later, the display in step 1 returns, and CLOCK SET ▼ is displayed.
- 7 Press ON/OFF button.**
The timer mode is finished.

NOTICE

- If you press ON/OFF button while timer mode is under setting, timer mode is canceled and the display will return to the original one. Note that the setting which has not been completed is canceled.
- If you do not press any button for several minutes after entering the timer mode, the timer mode ends and the display returns to the original one.

SLEEP TIMER MODE

After a certain period of time has elapsed, operation stops.

- Sleep timer
The unit stops after the set time elapses.



1 2•4 3•5

NOTICE

- If you press ON/OFF button while timer mode is under setting, timer mode is canceled and the display will return to the original one.
- If you do not press any button for several minutes after entering the timer mode, the timer mode ends and the display returns to the original one.

OFF TIMER MODE

The unit stops operating at the setting time.
This setting is effective for only once.



1 2•4 3•5

ATTENTION

Once the OFF timer is set, it is not possible to start operation. If you would like to operate the air conditioner, press ON/OFF button before hand to turn on.

NOTICE

- If you press ON/OFF button while timer mode is under setting, timer mode is canceled and the display will return to the original one.
- If you do not press any button for several minutes after entering the timer mode, the timer mode ends and the display returns to the original one.

- 1 Press TIMER button.**
- 2 Press ▼ button once.**
 CLOCK SET ▼ → SLEEP TIMER ◀
- 3 Press SET button.**
[EXAMPLE] " 1 OFF " flashes,
 SET TIMER " lights.
- 4 Press ▲ or ▼ button.**
The display changes as below. Set as you like.
" 1 OFF " ↔ " 2 OFF " ~ " 9 OFF " ↔ " 10 OFF "
- 5 Press SET button.**
Sleep timer has been set.
The air conditioner will turn on if a sleep timer is set while it is turned off.
After TIMER SET OK is displayed in the display area, the display in step 2 returns.
<When "Ten hours later OFF" is set >
" 10 OFF " (lights)
 TIMER SET OK " (lights for two seconds)
↓
" 10 OFF " (lights)
 SLEEP TIMER ◀ (lights)
The remaining time is displayed, and changes in an hourly basis.
When the setting time elapses, the unit stops operating.
Every operation stops after a certain period of time has elapsed.
- 6 Press ON/OFF button.** The timer mode is finished.

- 1 Press TIMER button.**
- 2 Press ▼ button twice.**
 CLOCK SET ▼ → SLEEP TIMER ◀ → OFF TIMER ◀
- 3 Press SET button.**
[EXAMPLE] " PM 4:00 " flashes,
 SET TIMER " lights.
- 4 Press ▲ or ▼ button.**
Set the time at which you want to stop the operation.
• Set "Hour"
If you press ▲ or ▼ button for a while, "Hour" display is changed by one hour, and stops when you stop pressing.
• Set "Minute"
If you press ▲ or ▼ button, the number in the display becomes larger or smaller by ten minutes.
- 5 Press SET button.**
OFF timer has been set.
After TIMER SET OK is displayed in the display area, the display in step 2 returns.
<If set to 6:00 PM >
" PM 6:00 " (lights)
 TIMER SET OK " (lights for two seconds)
↓
" PM 6:00 " (lights)
 OFF TIMER ◀ (lights)
The unit stops operating at 6:00 PM.
The time display is also turned off.
- 6 Press ON/OFF button.** The timer mode is finished.

ON TIMER MODE

The unit starts to operate at the set time. It is possible to set temperature at which you want to start the operation. Only one setting is applicable to each operation.

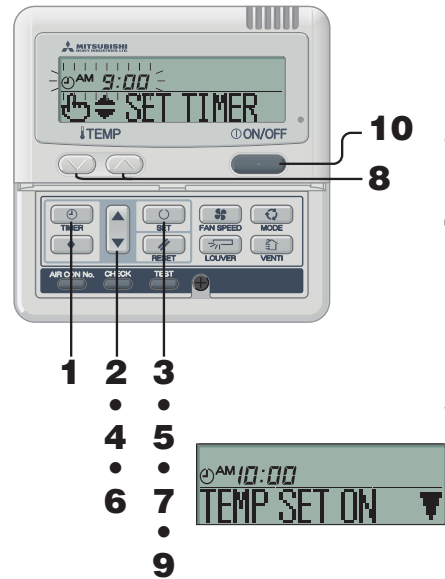

- 1 Press TIMER button.
- 2 Press button for three times.
[CLOCK SET] → [SLEEP TIMER] → [OFF TIMER] → [ON TIMER]
- 3 Press SET button.
[EXAMPLE] "AM 9:00" flashes, "SET TIMER" lights.
- 4 Press or button.
Set the preferred time to start the operation
 - Set "Hour"
If you press or button for a while, "Hour" display is changed by one hour, and stops when you stop pressing.
 - Set "Minute"
If you press or button, the number in the display becomes larger or smaller by ten minutes.
- 5 Press SET button.
ON timer has been set.
The left image is displayed in the display area.
<If set to 10:00 AM >
"AM 10:00" (lights)
"TEMP SET ON" (lights)
- 6 Press or button.
Press button and "TEMP SET OFF" (lights) is displayed
Press button and "TEMP SET ON" (lights) is displayed
Select either of the above two.
 - Go to step 7 if temperature is set.
 - Go to step 9 if temperature is not set.
- 7 Press SET button.
The left image is displayed in the display area.
<If set to 10:00 AM >
"AM 10:00" (lights)
"27°C" (The current set temperature is displayed flashing)
"SET UP" (lights)
- 8 Press or button to set temperature.
If you press or button, the number in the display becomes larger or smaller by 1°C.
Set temperature at which you want to start the operation.

If you press the RESET button, the remote control will return to the previous screen.
- 9 Press SET button.
ON timer is set, and after "TIMER SET OK" is displayed, the display in step 2 returns.
<If set to 10:00 AM >
"AM 10:00 27°C" (lights)
"TIMER SET OK" (lights)
"AM 10:00 27°C" (lights)
"ON TIMER" (lights)
Set temperature is displayed only in case it is set.
The unit starts to operate at setting time with set temperature.
The time display is turned off.
- 10 Press ON/OFF button.
The timer mode is finished.

NOTICE

- If you press the ON/OFF button while timer mode is under setting, timer mode is canceled and the display will return to the original one.
- If you do not press any button for several minutes after entering the timer mode, the timer mode ends and the display returns to the original one.

- ON timer and either Sleep timer or OFF timer are set together, the temperature of ON timer is not displayed.
- ON timer and either Sleep timer or OFF timer are set together, OFF timer (or Sleep timer) precedes.

WEEKLY TIMER MODE

Selection of Weekly timer mode
You can set up to four ON/OFF timers per day.
Note : Set time every month in Weekly timer mode.

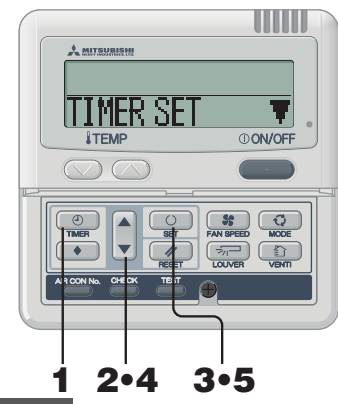

NOTICE

- If you press ON/OFF button while timer mode is under setting, timer mode is canceled and the display will return to the original one.
- If you do not press any button for several minutes after entering the timer mode, the timer mode ends and the display returns to the original one.

WEEKLY TIMER SETTING

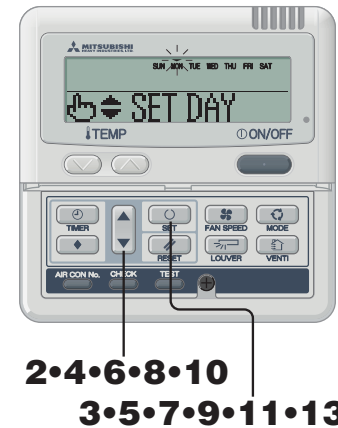

<In case Monday is set>

[EXAMPLE]
Number 1 : AM 9:00
Number 2 : PM 8:00
Number 3 : PM 1:00
Number 4 : PM 5:00
* Four operations can be set with only ON timer or only OFF timer.

- 1 Press TIMER button.
- 2 Press button for four times.
[CLOCK SET] → [SLEEP TIMER] → [OFF TIMER] → [ON TIMER] → [WEEKLY TIMER]
- 3 Press SET button.
"TIMER SET" (lights) is displayed in the display area.
- 4 Press or button.
By pressing or button, it is possible to choose the item to set.
"TIMER SET" (lights) (for setting the timer)
"HOLIDAY SET" (lights) (for setting the selected day of the week to holiday)
"CHECK/CANCEL" (lights) (for checking the timer setting and canceling individual settings)
- 5 Press SET button.
The selected mode is fixed.
- 1 In the Weekly timer mode, select "TIMER SET" (lights) and press SET button to confirm.
See step 1 to 5 in "Selection of Weekly timer mode" above
"SUN MON TUE WED THU FRI SAT" (lights) (flashing)
"SET DAY" (lights) is displayed in the display area.
- 2 Press or button.
Set the mark above the day of the week to the day to be set for timer setting. Press and to move to the right and left respectively, and will move flashing.
If you press the button, the day ("SUN" to "SAT") indicated with the flashing "" mark will change one day at a time. If you press the button when the "" mark is indicating "SAT", multiple "" marks will appear and flash above "MON" to "FRI". Press the button again, and multiple "" marks will appear and flash above "SUN" to "SAT" (every day). The same schedule can be applied to all the days indicated with the "" marks by using this function.
Press RESET button to return to "selecting Weekly timer mode screen", and "TIMER SET" (lights) is displayed.
See the above step 3.
- 3 Press SET button.
The "" mark above the day stops flashing and lights, which indicates that the setting is fixed.
"SELECT No." (lights) is displayed as the left image.
- 4 Press or button.
Up to four schedules can be set for each day. Select the timer schedule number you want to set. Set either ON timer or OFF timer for each single operation. (See the left EXAMPLE).
Press button to make the mark next to the number flash and move downwards.
Press the button to move the mark upwards.
1
2
3
4
Press the RESET button to return to the display in step 1.



5 Press SET button.
 ◀ mark next to a number lights.
 ◀ ON TIMER ▼ or ◀ OFF TIMER ▲ is displayed.
 The settings so far are effective and the display changes as shown on the left.

6 Press ▲ or ▼ button.
 Press ▼ button and ◀ OFF TIMER ▲ is displayed.
 Press ▲ button and ◀ ON TIMER ▲ is displayed.
 Select either of the above two.
 Press the RESET button to return to the display in step 3.

7 Press SET button.
 ◀ SET TIMER is displayed

8 Press ▲ or ▼ button.
 Set the time.
 Press the RESET button to return to the display in step 5.

9 Press SET button.
 When time display lights, the time is fixed.
In case of OFF timer setting, setting process is completed on this step.
 A "_" mark lights (MON → MON) under the day of the week which you set and the display appears as the left image.
 Proceed to "Next setting and Exiting Weekly timer Mode" on the right page.
In case of ON timer setting, "TEMP SET ON ▼" is displayed, proceed to step 10.

10 Press ▲ or ▼ button.
 Select either "TEMP SET ON ▼" or "TEMP SET OFF ▲".

11 Press SET button.
In case "TEMP SET OFF ▲" has been selected, ON timer setting process is completed.
 A "_" mark lights (MON → MON) under the day of the week which you set and the display appears as the left image.
 Proceed to "Next setting and Exiting Weekly timer Mode" on the right page.
In case "TEMP SET ON ▼" has been selected, "◀ SET UP" is displayed; Proceed to step 12.

12 Press the temperature setting buttons or .
 Press the or the button to increase or decrease by 1°C.
Set the temperature at the start of operation.
 Press the reset button to return to the display "TEMP SET ON ▼".

13 Press SET button.
ON timer setting with start-up temperature has been completed.
The value of the temperature stops flashing and lights.
 A "_" mark lights (MON → MON) under the day of the week which you set and the display appears as the left image.
 Proceed to "Next setting and exiting Weekly timer mode" on the right page.

<When ◀ OFF TIMER ▲ is selected>



Next setting and exiting Weekly timer mode
 After "◀ SELECT" is displayed, "SELECT No. ▼" is displayed.



1 Press ▲ or ▼ button.
 By pressing ▲ or ▼ button, it is possible to choose the item to set.
 "SELECT No. ▼" (select the next timer operation number within the same day)
 "DAY SET ▲" (select the next day)
 "END ▲" (Timer mode ends)

2 Press SET button.
 If "SELECT No. ▼" is selected, "◀ SELECT No." is displayed. Repeat step 3 and the subsequent steps of Weekly timer setting on page 7.
 If "DAY SET ▲" is selected, "◀ SET DAY" is displayed. Repeat step 1 and the subsequent steps of Weekly timer setting on page 7.
 If "END ▲" is selected, timer mode ends.

NOTICE

- If you press button while timer mode is under setting, timer mode is canceled and the display will return to the original one.
- If you do not press any button for several minutes after entering the timer mode, the timer mode ends and the display returns to the original one.
- If you select a day of the week for which setting have already been made, all the timer numbers that have been set are displayed. And the details of the timer setting for the number which has "◀" mark is displayed. You can modify the selected setting by overwriting it.
- If you set ON timer and OFF timer operating at the same time, OFF timer will precede.
- If the same two times are set for ON timer on the same day, the lower number precedes.

Display after Weekly timer modes setting

- The day of the week set is underlined.
- The ▼ mark is displayed above the current day of the week.
- The display of all the timer operation numbers set for the current day is turned on. The ◀ mark indicates the next setting number to be activated, and the set time is displayed.
- The timer operations are executed in order, and the number and time display are turned off when all the timer operations for the current day are completed.

Weekly timer Holiday Setting

It is possible to temporarily disable each day's timer setting by using the Holiday Setting. When the Holiday Setting is cancelled, the timer setting is enabled again.

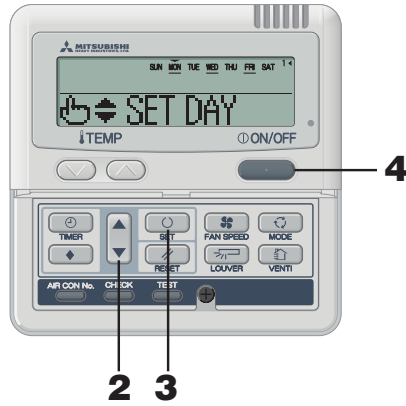

1 In the Weekly timer mode, select and set "HOLIDAY SET".

See "Selection of Weekly timer mode" step 1 to 5 on page 7.

"SUN MON TUE WED THU FRI SAT" is displayed in the display area (▼ is flashing)

"SET DAY" is displayed.

2 Press ▲ or ▼ button.
Move the "▼" mark displayed above the days of week to the day which you want to set as Holiday.

Press ▲ and ▼ to move to the right and left respectively. If you press the ▲ button, the day ("SUN" to "SAT") indicated with the flashing "▼" mark will change one day at a time. If you press the ▲ button when the "▼" mark is indicating "SAT", multiple "▼" marks will appear and flash above "MON" to "FRI". Press the ▲ button again, and multiple "▼" marks will appear and flash above "SUN" to "SAT" (every day). The same schedule can be applied to all the days indicated with the "▼" marks by using this function. This can be used in case you would like to apply Holiday setting to these days.

In case press the RESET button, the remote control will return to the previous screen and display "HOLIDAY SET".

3 Press SET button.

The "▼" mark above the day stops flashing and lights, and the day set as a holiday also lights enclosed with (). Then, the following is displayed.

[SUN (MON) TUE WED THU FRI SAT] (lights)
"HOLIDAY SET OK" (lights for two seconds)

[SUN (MON) TUE WED THU FRI SAT] (lights)
"SET DAY" (lights)

After the holiday setting has been completed, the display of the remote control returns to that of step 1. Repeat step 2 and 3 to continue setting further holidays.

NOTICE

If you set a day of the week for which no timer operation is set, "NO SETTING" is displayed for two seconds and the display returns to the one shown in step 1.

4 Press ON/OFF button.
Timer mode ends.

Canceling Holiday Setting

1 In the Weekly timer mode, select and set "HOLIDAY SET".

See "Selection of Weekly timer mode" step 1 to 5 on page 7.

2 Press ▲ or ▼ button.
Move the "▼" mark displayed above the day of week to the day on which you want to cancel Holiday setting.
Select the day of the week that has been set as holiday.

3 Press SET button.
() display is turned off and the following is displayed.

[SUN MON TUE WED THU FRI SAT] (lights)
"HOLIDAY CANCEL" (lights for two seconds)

[SUN MON TUE WED THU FRI SAT] (lights)
"SET DAY" (lights)

After the holiday setting has been completed, the display of the remote control returns to that of step 1. Repeat step 2 and 3 to continue canceling further holiday settings.

4 Press ON/OFF button.
Timer mode ends.

- NOTICE**
- If you press ON/OFF button while timer mode is under setting, timer mode is canceled and the display will return to the original one.
 - If you do not press any button for several minutes after entering the timer mode, the timer mode ends and the display returns to the original one.

Weekly timer Checking

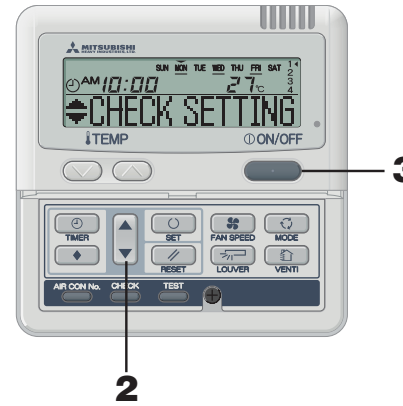

1 In the Weekly timer mode, select and set "CHECK/CANCEL".

See "Selection of Weekly timer mode" step 1 to 5 on page 7. The display shows the detailed timer operation setting information of the smallest timer operation number on the day of the week as shown on the left. (But if not set, "NO SETTING" is displayed.)

2 Press ▲ or ▼ button.
Detailed timer operation settings are displayed in accordance with the timer operation you have selected.
Press ▼ button to display from Sunday and the lowest timer operation number.
Press ▲ button to display the settings in the reverse order.

3 Press ON/OFF button.
Timer mode ends.

Weekly timer mode Setting Canceling

It is possible to cancel Weekly timer mode settings of each day of the week, as well as individual timer operation number. See "Timer Operation Cancellation Mode" on page 10 to cancel settings of all days of week.

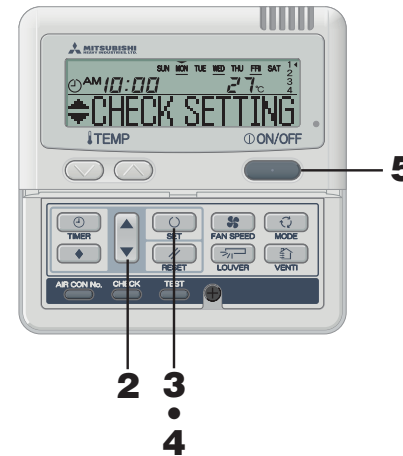

1 In the Weekly timer mode, select and set "CHECK/CANCEL".

See "Selection of Weekly timer mode" step 1 to 5 on page 7. The display shows the detailed timer operation setting information of the smallest timer operation number on the day of the week as shown on the left.

2 Press ▲ or ▼ button.
Detailed timer operation settings are displayed in accordance with the timer operation you have selected.
Press ▼ button to display from Sunday and the lowest timer operation number.
Press ▲ button to display the settings in the reverse order.
Select the timer operation number on a day of the week you want to cancel.

If you press the RESET button, the remote control will return to the previous screen, and display "CHECK/CANCEL".

3 Press SET button.
"CANCEL?" is displayed.

If you press the RESET button, the remote control will return to the previous screen, and display "CHECK SETTING".

4 Press SET button.
"CANCELLED" is displayed, and the displayed detail timer operation setting disappears and is canceled.
"CHECK SETTING" is displayed again.
Repeat step 2 to 4 to continue canceling other settings.

5 Press ON/OFF button.
Timer mode ends.

- NOTICE**
- If you press ON/OFF button while timer mode is under setting, timer mode is canceled and the display will return to the original one.
 - If you do not press any button for several minutes after entering the timer mode, the timer mode ends and the display returns to the original one.

TIMER CANCELLATION MODE

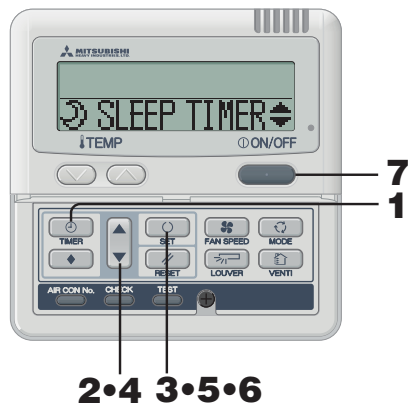

1 Press [TIMER] button.
Timer mode begins.
The current "The day of the week" and "the current time" are displayed.

[SUN MON TUE WED THU FRI SAT]
" PM 1:00 "
[CLOCK SET]

- 2 Press [DOWN] button for five times.**
- [CLOCK SET]
 - [SLEEP TIMER] (▼ first press)
 - [OFF TIMER] (▼ second press)
 - [ON TIMER] (▼ third press)
 - [WEEKLY TIMER] (▼ fourth press)
 - [TIMER CANCEL] (▼ fifth press)

3 Press [SET] button.
Timer Cancellation Mode begins.

- 4 Press [UP] or [DOWN] button.**
By pressing [UP] or [DOWN] button, it is possible to choose the item to cancel.
- [SLEEP TIMER]
 - ↑
 - [OFF TIMER]
 - ↓
 - [ON TIMER]
 - ↓
 - [WEEKLY TIMER] (canceling all days of the week)

If you press the [RESET] button, the remote control will return to the previous screen, and display "TIMER CANCEL ▲".
(step 2 above)

In case "[SLEEP TIMER]", "[OFF TIMER]" or "[ON TIMER]" was selected.

5 Press [SET] button.
The detailed setting of selected timer mode is displayed as shown below.
(But if not set, "NO SETTING" is displayed)
<Display EXAMPLE when "[ON TIMER]" is selected>



If you would like to quit cancellation, press the [RESET] button to return to the "[ON TIMER]" display. (step 4 above)

6 Press [SET] button.
The display of the detailed timer setting is turned off, and after the message "CANCELLED" is displayed for two seconds, "[SLEEP TIMER]" is displayed again. (step 4 above)
Repeat steps 4 to 6 to continue canceling timer mode settings.

NOTICE

- If you press [ON/OFF] button while timer mode is under setting, timer mode is canceled and the display will return to the original one.
- If you do not press any button for several minutes after entering the timer mode, the timer mode ends and the display returns to the original one.

In case "[WEEKLY TIMER]" was selected.

All the Weekly timer setting will be canceled if you proceed the following steps.
To cancel a part of the timer setting, please see "Canceling Weekly timer Mode Setting" on page 9.

5 Press [SET] button.
The settings are displayed as shown below.
(But if not set, "NO SETTING" is displayed)



If you would like to quit cancellation, press the [RESET] button to return to the "[WEEKLY TIMER]" display. (step 4 above)

6 Press [SET] button to confirm.
The day of the week display area turns off, and after the message "CANCELLED" is displayed for two seconds, the display returns to "[SLEEP TIMER]". (step 4 above)
These operation settings cancel all days of the week.

7 Press ON/OFF button.
Timer mode ends.

SILENT MODE

When the silent mode is set, the unit operates more silently reducing noise from the outdoor unit. The system applies the silent operation mode at the starting time to be set, and finish it after a certain period of time has passed.

Once the system is set to operate with the silent mode, the setting is applied everyday until it is canceled.

■ Silent Mode Setting



- 1
- 3
- 2
-
- 5
- 4
-
- 7
- 6
-
- 8

1 In the timer mode, set the current day of the week and current time.
See page 6 step 1 to 7

2 Press [SET] button for three seconds or more.
The remote control goes into silent mode setting and the following is displayed.
"SET SILENT ▼" or "CANCEL SILENT ▲" (lights)

3 Press [UP] or [DOWN] button.
If [DOWN] button is pressed, "CANCEL SILENT ▲" is displayed. If [UP] button is pressed, "SET SILENT ▼" is displayed. Select "SET SILENT ▼".

If you press the [RESET] button, the remote control return to the original screen.

4 Press [SET] button.
The following setting is displayed.

" PM 5:00 " (flashing)
" SET TIMER " (lights)



5 Press [UP] or [DOWN] button.
Set the "ON TIME".

- Set "Hour"
If you hold [UP] or [DOWN], the number in "Hour" display changes, and if you release it, the number stops changing.
- Set "Minute"
If you press [UP] or [DOWN] button, the number in the display becomes larger or smaller by ten minutes.

If you press the [RESET] button, the remote control return to the "SET SILENT ▼" display.

6 Press [SET] button.
The ON TIME is set and the following is displayed.

" PM 5:00 " (flashing)
" TIMER SET OK " (lights for two seconds)

↓
" OFF " (flashing)
" SET TIMER " (lights)



7 Press [UP] or [DOWN] button to set the duration.
Select OFF time.

When you press [UP] button, and the duration is increased by two hours as below, " 2 OFF " → " 4 OFF " → " 22 OFF " → " 24 OFF "

When you press [DOWN] button, and the duration is decreased by two hours.

If you press [RESET] button, the "ON TIME SET" display returns.

8 Press [SET] button.
The setting is fixed and displayed.
"SET COMPLETE" is displayed, and the silent mode setting ends. The setting display turns off, and returns to original display.

■ Canceling Silent Mode (Setting)

Select "CANCEL SILENT ▲" in step 2, press [SET] button and silent setting is canceled ending the silent mode.
"CANCELLED" is displayed.

NOTICE

- The remote control has main-sub units, silent setting cannot be operated with sub unit.
- After the silent mode is set, the following is displayed for 3 seconds at the set time and the unit returns to the original display.
At the ON time : " SILENT MODE ON "
At the OFF time : " SILENT MODE OFF "
- If you select " 24 OFF ", you can continue the silent mode until it is canceled. At the first ON time, the display shows " SILENT MODE ON " for three seconds and returns to original display.

• If you press [ON/OFF] button while timer mode is under setting, timer mode is canceled and the display will return to the original one. Note that the setting which has not been completed is canceled.

HOW TO ADJUST THE LOUVER (IN CASE OF FDT, FDTC, FDE) < WIRED REMOTE CONTROL >

ADJUSTING WITH LOUVER BUTTON (Indoor unit with auto swing function)

Press LOUVER button once, and the current status of louver is displayed.



The display during auto swing	SWING
The display with the louver position fixed	STOP 1
	STOP 2
	STOP 3
	STOP 4

When you operate the swing louver

1. Press LOUVER button, and change the display to "SWING ".

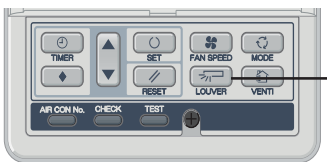

SWING

The function of the swing louver during the heating preparation, heating/defrost

" " or "Heating/Defrost" is displayed, the position of the swing louver is automatically switched to horizontal.

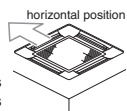

When the operation is switched to normal after "The heating preparation" or "Heating/Defrost" ends, the position of swing louver returns to the last setting.

CAUTION

- Do not move the swing louver forcibly by hands for fear that it may be damaged.
- Do not blow downwards during cooling operation for a long time for fear that dew condensation may be formed at the side panel. (In case of FDE)

HOW TO ADJUST THE LOUVER

(IN CASE OF FDF CONTROL)

ADJUSTING WITH LOUVER BUTTON (Indoor unit with auto swing function)

Press LOUVER button once, and the current status of louver is displayed.



The display during auto swing	SWING
The display during stop	LOUVER STOP

HOW TO SET THE AIRFLOW DIRECTION (IN CASE OF FDT, FDTC, FDE) < WIRED REMOTE CONTROL >

It is possible to change the movable range of the louver on the air outlet from the wired remote control. Once the top and bottom positions are set, the louver will swing within the range between the top and the bottom positions when swing operation is chosen. With Ceiling cassette -4 way - FDT and FDTC, it is also possible to apply different setting to each louver.



2•4•6•8 1
3•5•7•9

NOTICE

- For FDT and FDTC type, in case the louver No. to be set is uncertain, set any louver temporarily. The louver will swing once when the setting is completed and it is possible to confirm the louver No. and the position. After that, choose the correct louver No. and set the top and bottom positions.
- For FDE type, set louver No. 1. Other settings selected have no effect.

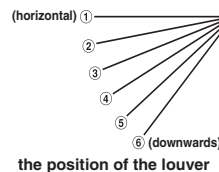
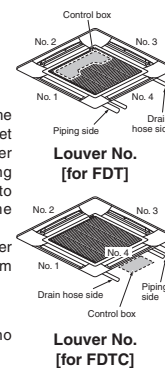

- 1 Stop the air conditioner and press SET button and LOUVER button simultaneously for three seconds or more.

The following is displayed if the number of the indoor units connected to the remote control is one. Go to step 4.

"DATA LOADING "

"No.1 ▲"

The following is displayed if the number of the indoor units connected to the remote control are more than one

"SELECT I/U "

"I/U000 ▲"



- 2 Press or button.(selection of indoor unit)

Select the indoor unit of which the louver is set.

[EXAMPLE]

"I/U000 ▲" ↔ "I/U001 ◀" ↔ "I/U002 ▶" ↔ "I/U003 ◀"

- 3 Press SET button. (determination of indoor unit)

Selected indoor unit is fixed.

[EXAMPLE]

"I/U001 " (lights for two seconds)

"DATA LOADING "

"No.1 ▲"



- 4 Press or button. (selection of louver No.)

Select the louver No. to be set according to the left figure.

[EXAMPLE]

"No.1 ▲" ↔ "No.2 ◀" ↔ "No.3 ▶" ↔ "No.4 ▼"

Note : For FDE, select "No.1 ▲". Other louver No. settings have no effect.

- 5 Press SET button. (Determination of louver No.)

The louver No. to be set is confirmed and the display shows the upper limit of the movable range.

[EXAMPLE] If No.1 louver is selected,

"No.1 UPPER2 ◀" ← current upper limit position

- 6 Press or button. (selection of upper limit position)

Select the upper limit of louver movable range.

"position 1" is the most horizontal, and "position 6" is the most downwards.

"position --" is to return to the factory setting. If you need to change the setting to the factory setting, use "position --".

"No.1 UPPER 1 ▼" (The most horizontal)

↔ "No.1 UPPER2 ◀"

↔ "No.1 UPPER3 ◀"

↔ "No.1 UPPER4 ◀"

↔ "No.1 UPPER5 ◀"

↔ "No.1 UPPER6 ◀" (The most downward)

↔ "No.1 UPPER-- ▲" (Return to the position of shipment)



7 Press SET button (Fixing of the upper limit position)

The upper limit position is fixed and the setting position is displayed for two seconds. Then proceed to lower limit position selection display.

[EXAMPLE]
 "No.1 UPPER2" (lights for two seconds)
 ↓
 "No.1 LOWER5" (shows current setting)

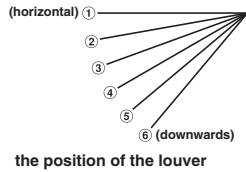

8 Press or button (Selection of lower limit position)

Select the lower limit position of louver.
 "position 1" is the most horizontal, and "position 6" is the most downwards.
 "position --" is to return to the factory setting. If you need to change the setting to the factory setting, use "position --".

"No.1 LOWER1" (the most horizontal)
 ⇔ "No.1 LOWER2"
 ⇔ "No.1 LOWER3"
 ⇔ "No.1 LOWER4"
 ⇔ "No.1 LOWER5"
 ⇔ "No.1 LOWER6" (the most downwards)
 ⇔ "No.1 LOWER--" (return to the position of shipment)



[EXAMPLE] For Upper position 2, Lower position 6

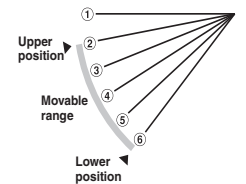

Note : If the upper limit position number and the lower limit position number are set to the same position, the louver is fixed at that position. And auto swing does not function.

9 Press SET button (Fixing of the lower limit position)

The upper limit position and lower limit position are fixed, the set positions lights for two seconds, and then the setting is completed.
 • After the setting is completed, the louver which was set moves from the original position to the lower limit position, and goes back to the original position again. (This operation is not performed if the indoor unit and/or indoor unit fan is in operation.)

[Example]
 "No.1 U2 L6" (lights for two seconds)
 ↓
 "SET COMPLETE"
 ↓
 "No.1" (return to original position)

10 Press ON/OFF button.
 Louver adjusting mode ends and returns to the original display.

NOTICE

- If you press RESET button during settings, the display will return to previous display. If you press ON/OFF button during settings, the mode will end and the original display will return, and the settings that have not been completed will become invalid.
- When plural remote controllers are connected, louver position setting cannot be set by slave remote control.

When the ventilator is set to "NO VENTI LINK", the ventilator can be turned on and off independently regardless of the operation of the air conditioner.

When the ventilator is set to "VENTI LINK", the ventilator operation will be interlocked with the air conditioner operation.



VENTILATION OPERATION NOT LINKED WITH UNIT'S OPERATION

1 Press VENTI button.
 "VENTI" is displayed, and the ventilation operation begins.

Stop Press VENTI button again.

NOTICE

- If no ventilator is connected, no operation can be performed by pressing the ventilation button. ("INVALID OPER" is displayed).

VENTILATION OPERATION LINKED WITH UNIT'S OPERATION

1 Press ON/OFF button.
 If a ventilator is connected, ventilation will operate automatically. "VENTI" is displayed.

Stop Press ON/OFF button again.

NOTICE

- No operation can be performed by pressing the ventilation button. ("INVALID OPER" is displayed).

FOR COMFORTABLE USE

Clean the filter frequently
See page 16

The filter should be cleaned when the "Filter cleaning" message is displayed, and at the ends of cooling and heating seasons.

- If the filter is clogged...**
- The cooling/heating capacity will get reduced. Moreover it leads to waste of electricity and larger operation noise.
 - It may cause failure.
 - Dew may form and drop during cooling.

Do not block the inlet and outlet grilles of the indoor and outdoor units.

Excessive load to the unit may cause failure.

Keep moderate room temperature

Too much cooling or heating is not good for your health. It will also waste the electricity.

Block direct sunlight and prevent draft

Block direct sunlight with blinds and curtains during cooling. Close the windows and doors except when ventilation is necessary.

Adjust the airflow properly

Do not expose yourself directly to the airflow for too long time. For small animals and plants, it is harmful as well.

If you feel cold underneath your feet during heating

If the ceiling is so high that the warm airflow does not circulate underneath your feet, it is recommended to use a circulator. Consult your dealer for more detail.

Stop the operation and turn the power supply off if there are any possibility of lightning strikes during a thunderstorm.

Lightning strikes may lead to the failure of air-conditioning system.

< WIRED REMOTE CONTROL >

WHEN THE CHECK INDICATOR LIGHT (RED) FLASHES



The air conditioner stops in the event any trouble occurs.

At the same time, the check indicator light flashes in red and the error code is displayed in the ON timer display area and the following is displayed in the display area.

"17000" ⇒ "PROTECT STOP"

(Air conditioner number)
(lights for 2 seconds by turns)

ERROR display when multiple indoor units are connected

If errors have occurred for all the connected air conditioning units. Initially, the error display shows the formation of the air conditioning unit whose number is the lowest. Errors of other air conditioning unit can be checked with the following procedure.



1 Press AIR CON No. button.
Enter AIR CON No. display mode.

2 Press ▲ button.
AIR CON No. and error codes are displayed in order from the lowest. Press ▼ button to display in the reverse order.

3 Press ON/OFF button.
Return to the AIR CON of the lowest number.

If errors have occurred for some of the connected AIR CON units.
Only the units for which errors have occurred stop operating. The remote control shows the operating units.



1 Press AIR CON No. button.
AIR CON No. display mode appears.

2 Press ▲ button.
AIR CON No. are displayed in order from the lowest. And error codes are displayed on the unit in trouble. Press ▼ button to display in the reverse order.

3 Press ON/OFF button.
Return to the AIR CON of the lowest number.

NOTICE

If ON/OFF button is pressed once while errors are displayed, the errors display is turned off, and the stop mode returns. If ON/OFF button is pressed again, the errors are displayed.

ROOM TEMPERATURE DISPLAY

If room temperature display setting is activated, room temperature is displayed on the remote control display. Then airflow display turns off, but airflow adjusting button is operative. Consult your dealer for settings.



The room temperature display

WHEN THE FILTER CLEANING MESSAGE IS DISPLAYED



The "FILTER CLEANING" is displayed when the cumulative operation time reaches to the predetermined number of hours in order to notify the time for cleaning.

Clean the air filter. See page 16 "FILTER CLEANING" is displayed in the display area. It is displayed for one second every five seconds while the unit is running. It stays lit while the system stopped.

After cleaning

1 Press RESET button.
The cumulative operation hours are reset and the "FILTER CLEANING" message turns off.

HOW TO DISPLAY AIR CON NO.

By operating AIR CON No. button, the number of the connected AIR CON unit and error codes of the units which have the record are displayed.



1 Press AIR CON No. button.
AIR CON No. display mode appears and the AIR CON of the lowest number is displayed. Other displays all turn off.

2 Press ▲ button.
AIR CON No. are displayed in order from the lowest. In addition, if any errors have occurred to the unit in the past, error codes can be found here too. Press ▼ button to display in the reverse order.

3 Press ON/OFF button.
Return to the original display.

NOTICE

The AIR CON No. can be displayed without relation to its modes of operation, stop, forcible stop due to an error. Buttons other than "AIR CON No." "▲" "▼" "ON/OFF" cannot be operated.

STANDBY DISPLAY

During the first operation after breaker power supply input or the recovery from power failure, "PREPARATION" can be displayed on the remote control for max 30 minutes. The refrigerant oil protection control is activated to protect the compressor and this isn't a failure. Please wait till the display turns off.



WIRELESS REMOTE CONTROL

In order to explain the displays in the liquid crystal display, all of them are shown in the figure below.

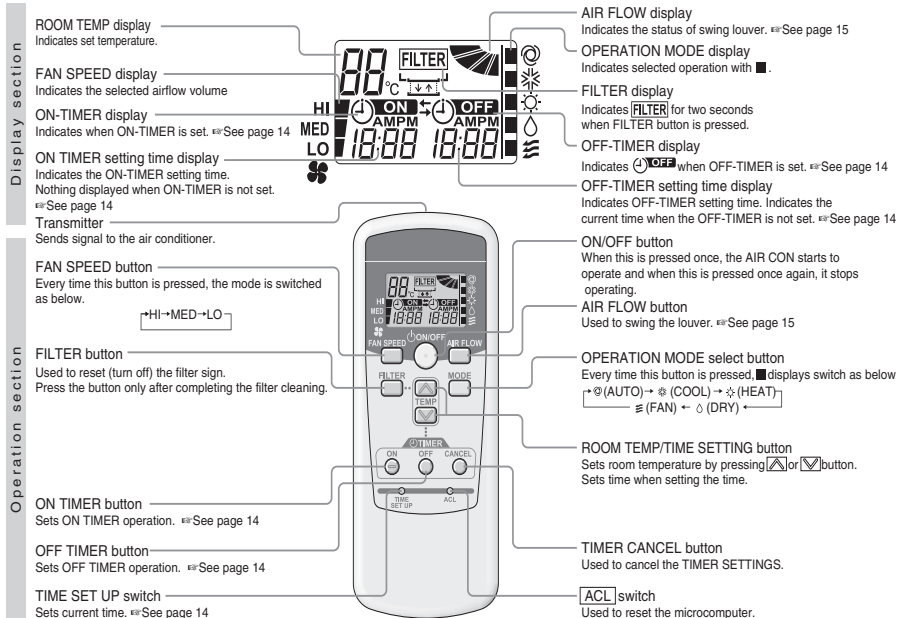

NOTICE If the display of remote control has troubles, press ACL switch.

WIRELESS REMOTE CONTROL HANDLING PROCEDURE

REPLACING THE BATTERIES

If the following occurs, the batteries are exhausted. Replace them with new ones.

- When the signal is transmitted, the AIR CON does not display reception.
- The display fades away or does not show anything.

1 Pull out the cover.

2 Replace the old batteries with new ones. (R03x2)

3 Close cover.

4 Adjust the current time. See page 14.

When any error occurs on the display, Press ACL switch with a ballpoint etc.

NOTICE

If the remote control is set as "Radio Interference Prevention Setting", it returns to default when the batteries are removed. It is necessary to perform the next procedures again.

When the batteries are inserted, each operation mode is set as the right figure. Adjust the current time referring to page 14. (The figure is for operation, and only the current time is displayed for stopping)

How to set Radio Interference Prevention Setting

It is possible to be sent in two ways. Press ACL switch with AIR FLOW button kept pressing or insert the batteries with AIR FLOW button kept pressing.

ATTENTION

- Do not use old and new batteries mixed.
- Remove the batteries when the remote control is not used for a long time.
- The recommendable effective period of a battery is about 6 to 12 months. (It depends on the usage.)

- The recommendable effective period is printed on the battery. This may be shorter due to manufacturing time of the unit.
- However the battery may be still working in order after expiry date.

HOW TO OPERATE

When you press each button of wireless remote control, directing properly to the receiving part of the air conditioner, the signal is transmitted. If the air conditioner receives the signal correctly, the light of operation indicator will flash.

ATTENTION

The operation of remote control must be performed slowly and steadily.

ABOUT REMOTE CONTROL HOLDER

The remote control can be mounted on the wall or pillar with the remote control holder. Slide from the upper part of the holder to place or take out the remote control.

ATTENTION

- Do not place the remote control to the following places.
 - The place exposed to direct sunlight or other strong lighting.
 - The place exposed to high temperature, for EXAMPLE, on the electric carpet or near a stove.
- If the signal receiving part of the air conditioner is exposed to direct sunlight or other strong lighting, it may not receive the signal. In this case, shut out the sunlight or turn down the lighting.
- Do not place anything between the remote control and the unit.
- Do not operate the remote control for other electric appliances which can be operated with a remote control.
- Handle it with utmost attention.
- Remove the batteries when the remote control is not used for a long time.
- Even if the remote control is not found or damaged, you can operate the air conditioner with itself. See "How to use the backup button" on page 15.

HOW TO OPERATE

- ATTENTION**
- In order to protect both indoor/outdoor air conditioners, keep the power supply on for six hours before initial operation. Do not turn off the power supply. (Power is distributed to the crankcase heater, even if the compressor is stopped. This keeps the compressor warm, and prevents failures caused by accumulation of liquid refrigerant.)
 - The operation of remote control must be performed slowly and steadily.

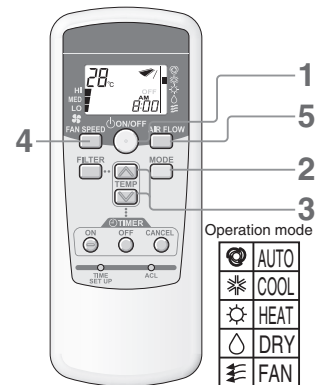

OPERATION

1 Press ON/OFF button.

The operation display light (Green) turns on, and the operation starts. The setting status is displayed on the liquid crystal area on the remote control.

2 Press MODE button.

Current operation mode is indicated with the ■ marks besides the operation mode icons. The mode will change in the following order by pressing the button.
 [⊙(AUTO) → ❄️(COOL) → 🔥(HEAT) → 🌀(FAN) → ☀️(DRY) → ⊙(AUTO)]

3 Press TEMP button.

Set the room temperature by pressing ◀ or ▶ button.

4 Press FAN SPEED button.

→ HI → MED → LO → FAN SPEED can be changed in order.

5 Press AIR FLOW button.

Effective AIR FLOW direction see page 15
 AUTO mode operation Intermediate
 Cooling, dehumidifying mode ... Horizontal
 Heating mode Downwards

Stop Press ON/OFF button

Guideline of room temperature setting

- COOL26 to 28°C
- DRY21 to 24°C
- HEAT22 to 24°C
- FAN.....TEMP setting is unnecessary

- Operation mode can be changed even when the unit stops.
- If you operate under the same condition (operation mode, set temperature, airflow, louver) just follow step 1, no other operations are necessary. The conditions which were set previously are indicated on the remote control

CURRENT TIME SETTING PROCEDURE

The timer is set on the current time. Adjust the current time correctly at first of all.

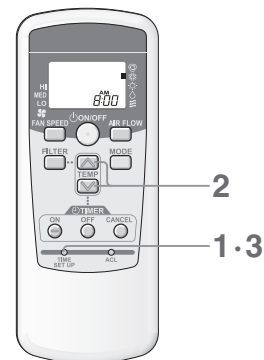

[EXAMPLE] AM (morning) 8:00 setting

1 Press TIME SET UP switch.

Press it with the tip of ballpoint etc. The time display blinks and can be set to the current time.

2 Press ◀ or ▶ button to adjust to AM 8:00.

Morning : AM After noon : PM
 The displayed time changes by 1 minute when pressing the button.
 • If ◀ or ▶ button is pressed during the blinking, fast-forward or fast-backward can be done.

NOTICE

- In case the buttons are not pressed for 60 seconds, the displayed time is set as current time without step 3.

3 Press TIME SET UP switch.

The value of the time displayed stops flashing and lights, and the setting is completed.

ON – TIMER OPERATION

Operation is started at the setting time.

[EXAMPLE] If you would like to start the operation at AM 8:00

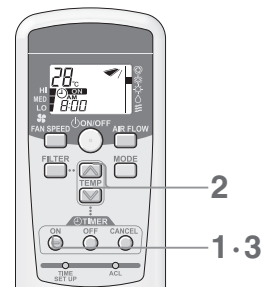

1 Press ON timer button.

ON timer display (ON) blinks.

2 Press ◀ or ▶ button to adjust to AM 8:00.

Displayed time will be changed by 10 minutes by pressing the buttons.

3 Press ON timer button.

- ON timer display (ON) stops flashing and lights, and the setting is completed. (Press within 60 seconds)
 TIMER/CHECK display lamp of the air conditioner lights. (The receiving part of indoor unit)
- At AM 8:00, TIMER/CHECK display lamp turns off and the air conditioner will start operating.

Cancellation

- Press CANCEL button to turn off the TIMER display and timer is canceled.
- After TIMER setting, if ON/OFF button is pressed before the setting time, TIMER display turns off and the TIMER is canceled.

Time change

Press ON TIMER button to set again.

- In case the ON timer is set while the air conditioner is in operation, it will be stopped and ready for restart at the setting time.

OFF – TIMER OPERATION

Operation is stopped at the setting time.

[EXAMPLE] If you would like to stop the operation at PM 9:00

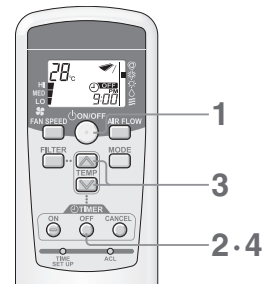

1 Press ON/OFF button when the air conditioner stops.

The air conditioner starts to operate. OFF timer can be set only in case the air conditioner is in operation.

2 Press OFF timer button.

OFF timer display (OFF) blinks.

3 Press ◀ or ▶ button to adjust to PM 9:00.

Displayed time will be changed by 10 minutes by pressing the buttons.

4 Press OFF timer button.

- OFF timer display (OFF) stops flashing and lights, and the setting is completed. (Press within 60 seconds)
 TIMER/CHECK display lamp of the air conditioner lights. (The receiving part of indoor unit)
- At PM 9:00, TIMER/CHECK display lamp turns off and the air conditioner will stop operating.

Cancellation

- Press CANCEL button to turn off the TIMER display and timer is canceled.
- After TIMER setting, if ON/OFF button is pressed before the setting time, TIMER display turns off and the TIMER is canceled.

Time change

Press OFF TIMER button to set again.

PROGRAM TIMER OPERATION

By setting both ON timer and OFF timer, the settings turn into PROGRAM timer mode. Operation and stopping can be performed at the same time of each day by setting program timer once.

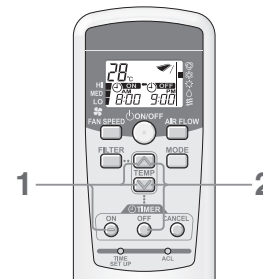

1 Set ON timer.

Press ON timer button and set the time with ◀ or ▶ button. Press ON timer button again.

2 Set OFF timer.

Press OFF timer button and set the time with ◀ or ▶ button. Press OFF timer button again.

Both ON TIMER and OFF TIMER are displayed. The direction of arrow mark changes depending on the status of operation.

⬅️ ON ➡️ OFF (stop) ➡️ ON ⬅️ OFF (operating)

Cancellation

- Whenever the CANCEL button is pressed, both ON and OFF timer display will be turned off and the PROGRAM timer mode will be cancelled. (Operation condition is kept as before the button is pressed.)
- Whenever the ON/OFF button is pressed, both ON and OFF timer display will be turned off and the PROGRAM timer mode will be cancelled. The air conditioner stops operating.

Changing the set time

Press OFF TIMER button or ON timer button to set again.

NOTICE

The same time cannot be set for OFF timer and ON timer.

UP AND DOWN ADJUSTING

How to move swing louver



Press AIR FLOW button when the air conditioner is in operation.

- The swing louver moves up and down, and the display moves too.

NOTICE

The louver position which the display shows is not synchronized with the actual position when the louver is swinging. But this is not a failure.



continuous movement of display

To fix the position of the swing louver

Press AIR FLOW button when the louver position indication comes to the position where you would like to fix it.

- Auto swing display stops at the position and then the swing louver stops and be fixed.

NOTICE

Press the button and auto swing display stops immediately, then the swing louver stops later, but this is not a failure. (Auto swing display and the actual louver movement of the air conditioner are not synchronized)

Recommended air flow direction position (when fixed)

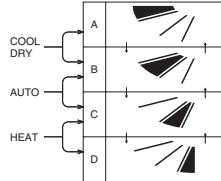

The swing louver movement during heat preparation

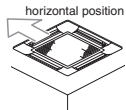

When "heat preparation" is displayed, the position of the swing louver sets horizontal automatically. (The display of remote control keeps the set position)

When heat preparation ends and normal operation starts, the position of the swing louver returns to the set position.

CAUTION

Do not set the position of the swing louver downwards for a long time. Dew formation on the side panel may drop. (in case of FDE)

FOR COMFORTABLE USE

See page 12

Ceiling suspended (FDE)

WHEN SHORT FLASHING LIGHT (lights for 0.5 seconds and blinks for 0.5 seconds) IS SHED FROM THE TIMER/CHECK INDICATOR LAMP (YELLOW)

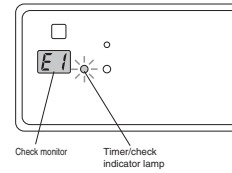

There is something wrong with the air conditioner.

- Immediately after the timer/check indicator lamp flashed (lights for 0.5 seconds and blinks for 0.5 seconds), the air conditioner stops.
- Address No. and error code are shown on the display on the indoor unit.
- The monitor display is turned off after the display time elapses.
- When nothing is displayed on the monitor, operate the remote control or press the BACKUP button to resume.

Please contact your dealer and inform them "address No. and error code", "symptom of the trouble", "air conditioner type" and "model name" etc.

- Press the ON/OFF button to stay the air conditioner on the stop mode.

WHEN LONG FLASHING LIGHT (lights for 2 seconds and blinks for 1 seconds) IS SHED FROM THE TIMER/CHECK INDICATOR LAMP (YELLOW)

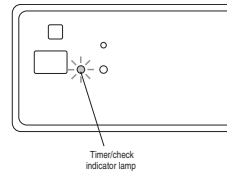

Clean the filter.

- When cumulative running time reaches to 120 hours, long flashing light (lights for 2 seconds and blinks for 1 second) is shed from the timer/check indicator lamp (yellow).
- After cleaning of filter, press the FILTER button on the remote control to turn off the filter cleaning sign. (Press the button for one second or more)

See page 16.

NOTICE

The cumulative running time for filter sign can be changed. Consult your dealer for more information.

Ceiling cassette -4 way- (FDT)

Ceiling cassette -4 way Compact (600x600mm) - (FDTC)

WHEN SHORT FLASHING LIGHT (lights for 0.5 seconds and blinks for 0.5 seconds) IS SHED FROM THE TIMER/CHECK INDICATOR LAMP (YELLOW)

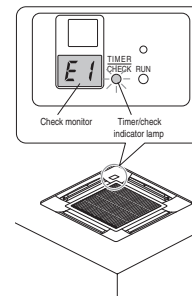

Something is wrong with the air conditioner.

- Immediately after the timer/check indicator lamp flashes (lights for 0.5 seconds and blinks for 0.5 seconds), the air conditioner stops.
- Address No. and error code are shown on the display on the indoor unit.
- The monitor display is turned off after the display time.
- When nothing is displayed on the monitor, operate the remote control or press the BACKUP button resume.

Please contact your dealer and inform them "address No. and error code", "symptom of the trouble", "air conditioner type" and "model name" etc.

- Press the ON/OFF button to stay the air conditioner on the stop mode.

WHEN LONG FLASHING LIGHT (Light for 2 seconds, wink out for 1 second) IS SHED FROM THE TIMER/CHECK INDICATOR LAMP (YELLOW)

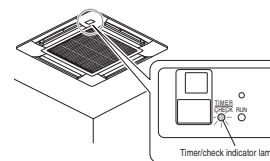

Clean the filter.

- When cumulative running time reaches to 120 hours, long flashing light (lights for 2 seconds and blinks for 1 second) is shed from the timer/check indicator lamp (yellow).
- After cleaning of filter, press the FILTER button on the remote control to turn off the filter cleaning sign. (Press the button for one second or more)

See page 16.

NOTICE

The cumulative running time for filter sign can be changed. Consult your dealer for more information.

BACKUP BUTTON

In case of battery exhausted, or loss or any trouble of remote control, the air conditioner can be operated with the BACKUP button on the indoor unit display part.

■ Ceiling suspended (FDE)

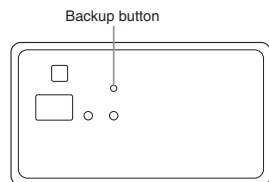

■ Ceiling cassette –4 way– (FDT)

Ceiling cassette –4 way Compact (600×600mm) – (FDTC)

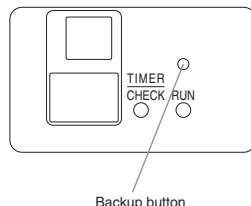

In case of FDE/FDT/FDTC

ON/OFF

■ Press backup button and leave it untouched for two seconds.

The operation starts.

■ Press it again to stop the operation.

SETTING

OPERATION MODE..... AUTO	FAN SPEED..... HI
TIMER No setting	SET TEMP..... 23°C
AUTO SWING..... STOP (HORIZONTAL)	

HOW TO MAINTAIN

How to clean the Air Filter

Clean the filter frequently for economical operation.

⚠ **Caution** Before cleaning, stop the operation and turn off the power supply.

Otherwise, it may lead to injury as fan inside rotates at high speed.

⚠ **Caution** The stepladder used for removing and attaching the air filter must be fixed firmly.

Otherwise, it may lead to injury due to overturn or fall.

⚠ **Caution** Be careful so that the dust does not get into your eyes when removing the air filter.

⚠ **Caution** Do not operate the air conditioner while the air filter is removed.

Piled up dust may lead to malfunction.

How to remove

Follow the instruction mentioned below according to the indoor unit type.

■ Ceiling cassette –4 way– (FDT)

• How to handle inlet grille/filter

Removal

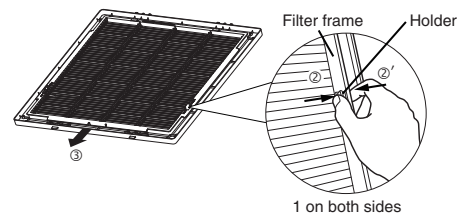
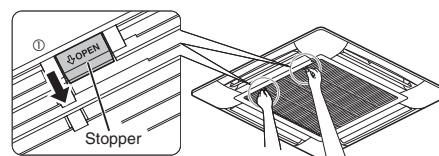

<How to remove the grille>

1. Hold the stoppers on the grille (2 places) to the "OPEN" direction (arrow mark ①), and then pull down to open the grille. Remove the hooks of the grille to dismount it.

<How to remove the filter>

1. Push holders (arrow mark ②) and filter frame (arrow mark ②'), and remove the filter from the holders. Then, slide the filter in the indicated direction (③) to remove it from the grille.

<How to mount the filter>

1. Check that the filter is on the right side and that its orientation is correct. Then, hook it to the hooks. (Insert in the way indicated with arrow mark ③)

2. Ensure to insert the holders of the grille into the filter's holes until clicking sounds are heard.

<How to mount the grille>

1. Mount the hooks of the grille to the holes on the panel. (The hooks on the grille can be mounted in all 4 directions.)

2. Close the grille while pressing the stoppers on the grille (2 places) to the "OPEN" direction. Then, release the stoppers.

⚠ **Caution** Mount the filter to the grille securely.

Otherwise, it may lead to decreased efficiency due to leakage of flow from the gap.

⚠ **Caution** Mount the grille securely.

Otherwise, it may fall.

⚠ **Caution** When the stopper is deformed or damaged, repair or replace without delay.

Otherwise, the grille may fall.

Mounting

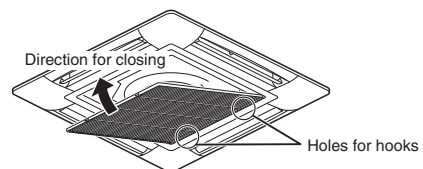
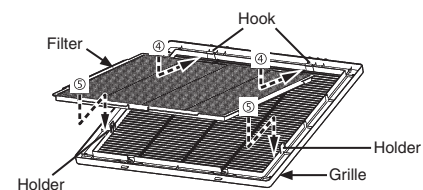

HOW TO MAINTAIN

Ceiling cassette –4 way Compact (600x600mm) – (FDTC)

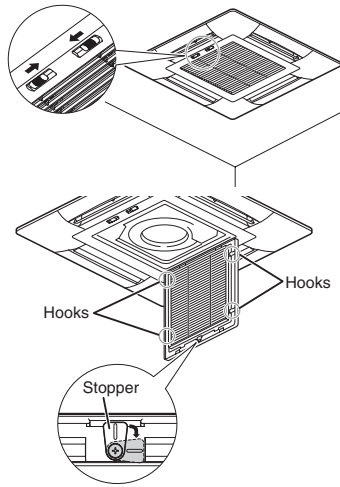

- Slide the inlet grille levers in the direction of the arrow (➡), and open it downwards.
- Release the inlet grille stopper.
- Pull the filter towards you.
- When the filter is put in place, insert the filter into the hooks on the inlet grille, and be sure to return the stopper to its original position.
- When putting the inlet grille back in place, slide the levers in the opposite direction and check to be sure that the grille does not come open.

Ceiling suspended (FDE)

- Slide the lever of the inlet grille backward (⇐ direction) and open it downwards.

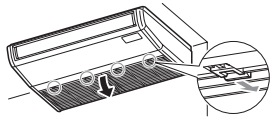

When mounting, press the lever forward until it snaps.

- Pressing the inlet grille, press the filter to remove it from the tab and pull it downwards.

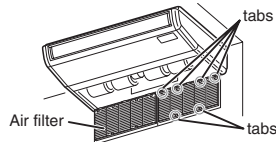

When attaching the filter, insert the filter into the tabs of the inlet grille.

Floor Standing (FDF)

Please take out the air filter by pulling carefully the both sides of the inlet grille.

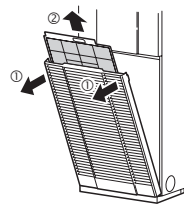

Duct connected –High static pressure– (FDU)

Duct connected –Middle static pressure– (FDUM)

Air filter is attached when the air conditioner is installed, so consult your dealer about how to remove or clean it.

How to clean

- Wash away for cleaning. If it is not so dirty, tap it or use cleaner.
If it is very dirty, dissolve some neutral detergent in lukewarm water (approximately 30°C), rinse the filter with it and wash the detergent away completely.
- After the air filter is dried, mount it to the main body and press RESET button.

ATTENTION

- Do not dry by exposing the air filter to the direct sunlight or using fire. Otherwise, the filter may be damaged.
- Do not operate the air conditioner with the filter removed. Otherwise it may lead to trouble.

MAINTENANCE OF THE UNIT

- Clean the unit by wiping with a piece of soft and dry cloth. If the unit is very dirty, wipe it with a piece of cloth wet with neutral detergent dissolved in lukewarm water and wipe it off with clean water.

AT THE END OF THE PERIOD OF USE (after a long period of use)

- Make sure to turn off the power supply. The air conditioner consumes several tens of watts electricity even if it is stopped.
- Clean the air filter and mount it.
- Clean the indoor/outdoor units.

AT THE BEGINNING OF THE PERIOD OF USE (after a long unused period)

- Make sure that there is no object blocking the airflow around the inlet and outlet grilles of the indoor/outdoor unit.
- Inspect the air filter. If it is dirty, clean and mount it.
- Turn on the power supply button for 6 hours before starting the operation.

TROUBLE SHOOTING

Check the following items before requiring service.

THE UNIT DOES NOT WORK AT ALL

Is the power supply switch turned off?



Is there a blackout or is the fuse blown?

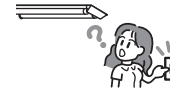

Is the leakage breaker activated?

Dangerous. Immediately turn off the power supply switch, and contact your dealer.

Is sunlight or other strong illumination striking the receive unit? (wireless unit)

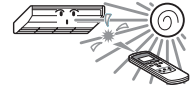

POOR COOLING OR HEATING

Is the air filter clogged?



Is the swing louver horizontal (during heating)?

If the swing louver is horizontal, the airflow may not reach down to the floor.



Are there any obstacles blocking the air inlet and outlet grill?

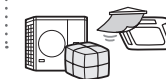

POOR COOLING

Is the direct daylight coming into the room?

- Are there any unexpected heat sources in the room?
- Are there too many people in the room?

NO AIRFLOW AT HEATING

Is the unit in the heating preparation mode?

See page 18



If, after checking the items above, the air conditioner still does not operate normally or in the next cases, stop operating and contact your dealer.

- If the fuse and breaker blow frequently.
- If water drips at cooling/dehumidifying operation.
- If the operation or operation noise is abnormal.
- If the check indicator light flashes.

The phenomena mentioned below is not malfunction.

The air conditioning system sounds as if water is draining from it.	Sounds of rustling or gurgling may be heard when the operation is started, when the compressor is activated/deactivated during operation, or when the operation is stopped. These are the sounds of the refrigerant flowing through the system.
Sounds of rustling or gurgling may be heard from a stopped indoor unit.	These sounds can be heard when the air conditioning system is performing automatic control.
The supply air from the indoor unit smells bad.	The supply air from the indoor unit may smell bad if the smell of cigarettes, cosmetics and/or furniture has saturated the air conditioning system.
White vapor is generated from the indoor unit during operation.	White vapor may be generated during operation if the system is used in environment where oils and fats are frequently used, such as in restaurants. In this case, consult the dealer and clean the heat exchanger.
The operation switched to fan operation during cooling operation.	The operation may switch to fan operation automatically in order to avoid frost being built up on the surface of the heat exchanger. The operation will soon return to cooling operation.
The indoor fan does not stop even when the operation is stopped in heating mode.	The indoor unit fan may continue operating for 40 seconds in order to remove remaining heat in the indoor unit. CAUTION Do not turn off the power supply until the fan stops.
The air conditioning system cannot start operating again immediately after stopping.	During the first 3 minutes after stopping operation, it is not possible to perform cooling, dehumidifying or heating operation even if the ON/OFF button is pressed to indicate "operation." This is because a circuit for protecting the compressor is activated (the fan is operating during this period).
No air comes out during dehumidifying operation. The airflow volume cannot be changed.	During dehumidifying operation, the fan speed is automatically controlled in low speed/stop cycle in order to avoid both drastic temperature drop and humidity rise.
The swing louver moves without any operation.	The swing louver automatically swings twice when the power supply switch is turned on. This is not a trouble. The louver also moves automatically to the horizontal position when "PREPARATION OF HEATING" is displayed.
The outdoor unit discharges water or steam during heating operation.	Water or steam is discharge during defrosting operation which removes frost built up on the surface of the heat exchanger in the outdoor unit in heating mode.
The outdoor unit fan is not running even when the system is in operation.	The fan speed is automatically controlled according to the ambient temperature. It may be stopped in high ambient temperature in case of heating, and in low ambient temperature in case of cooling. Also, the fan is stopped during defrosting operation. CAUTION The fan will suddenly begin to operate even if it is stopped. Do not insert finger and/or stick.

TROUBLE SHOOTING

The phenomena mentioned below is not malfunction.

Slapping sounds are heard.	These sounds are generated when plastic components are expanded or shrunk by the heat and rubbed with each other.
Hissing sounds are heard when the operation is stopped or during defrost operation.	These sounds are generated when the refrigerant valve inside the air conditioning system is activated.
The air conditioner starts operation automatically as soon as the power supply is turned on.	In case the automatic restart function is enabled, and when the power supply recovers, the system restarts the operation automatically as same condition as before power supply is cut. See below
The setting temperature cannot be changed (the setting temperature display flashes).	If changing the set temperature is prohibited on the remote control, it is not possible to change the temperature setting even ∇ or \blacktriangle is pressed. See right
In case of wireless remote control, the unit does not operate with the inspection display light on the indoor unit flashing even though any button on the remote control is pressed.	In case the system is controlled by the other centralized remote control and it forbids operating the system from the remote control, it is not possible to operate by the remote control.
Even if the wired remote control is operated, "central control" light only flashes and doesn't operate.	Is not "central controlling" or "center" displayed? If controlled with a separately purchased center console etc., the unit cannot be operated by the remote control.

PREPARATION OF HEATING

CASES WHEN (PREPARATION OF HEATING) IS DISPLAYED

(PREPARATION OF HEATING) is displayed in the remote control display area in the following cases.

For wireless devices, the run/check display lamp on the main body display unit will flash green. Setting temperature and preparation of heating are displayed on the wired remote control.

At Starting Heating Operation

In order to prevent cool air from blowing out, the airflow into the room may be stopped depending on the room temperature at the start of heating operation. please wait for a while and the operation automatically switches to the normal heating operation.

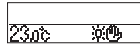

At defrost operation (during heating operation)

When frost may easily formed on the outdoor unit, the heating operation automatically is stopped (both indoor/outdoor unit stop fan operation) for approximately 5 to 10 minutes per hour and defrosting is operated. After the defrosting is complete, the operation automatically switches back to the normal operation.



HEATING OPERATION

Heat pump type

Heat pump type heating applies the mechanism that draws the heat from the outside air to warm up the room by means of the refrigerant.

Defrost operation

During heating with a heat pump type air conditioner, frost will be formed on the outdoor unit if the temperature outside the room drops. If left alone, the heating efficiency decreases. In order to deal with this, the operation is automatically switched to defrost operation to remove the frost. During the period, the airflow of indoor/outdoor unit is stopped and "heating defrost" is displayed.

Outer air temperature and heating capacity

The heating efficiency of heat pump type air conditioner decreases as the outside temperature becomes lower. If the capacity of air conditioner for heating is not sufficient, please use other heating device.

Time required until the room temperature increases

A heat type air conditioner circulates warm air to warm the entire room, so it takes a while to rise up the room temperature. It is recommended to start operation earlier on a very cold day.

When room temperature adjusting device operates during heating

If room temperature rises and the room temperature adjusting device is activated, the airflow becomes automatically low. When the room temperature drops, it switched back automatically to the normal operation.

AUTO RESTART <WIRED REMOTE CONTROL>

NOTICE

An auto restart function, which is disabled at the factory setting, is applicable to the remote control. Consult your dealer.

What is auto restart

When a power failure occurs or the power supply is turned off, the function allows the system to automatically resume operation with the remote control setting made set before the power failure when the power supply recovers. If the system is stopped before power failure it remains stopped after the power recover.

Note that in the following cases it is needed to set again with the remote control.

Timer setting is cancelled. But the sleep timer recovers after power failure recovers. When recovering from a power failure, holiday setting will override the weekly timer setting. And time setting returns to default. To return to original setting, after time setting, execute "holiday cancel".

Louver stops at the horizontal position.

CAUTION

Make sure to stop the operation before turning off the power supply when the auto restart function is enabled. (If the power supply is turned off while the system is operating, the indoor unit fan will start immediately when the power supply is turned on. In addition, the outdoor unit starts operating 3 minutes after the power supply is turned on.)

SETTING TO DISABLE BUTTON OPERATION <Wired remote control>

NOTICE

The following button operations can be disabled. If the button is pressed, "INVALID OPER" is displayed indicating that the button is disabled, and the original display returns. Consult your dealer for "INVALID OPER" setting.

- ① ON/OFF button
- ② TEMP button
- ③ LOUVER button
- ④ MODE button
- ⑤ FAN SPEED button
- ⑥ TIMER button

INSTALLATION, RELOCATION, AND INSPECTION MAINTENANCE

Please observe the following points in order to use the air conditioner in a safe and comfortable manner.

Make sure to request your dealer for installation, and do not attempt to do by yourself.

INSTALLATION LOCATION

Is the system installed in a well-ventilated place?

Are there any obstacles? If so, it leads to the decrease of the efficiency and the increase of operation noise.

Avoid the place where cool/warm air and operation noise cause problems to your neighbors.

ELECTRICAL WORK

Caution : Make sure to perform grounding work

Do not connect the ground wire to any gas pipe, water pipe, or wires of lightning conductors and telephones. If the ground work is not good, it may lead to electric shock.

Caution : A leakage breaker is necessary depending on the installation environment.

If it is not mounted there, it may lead to electric shock.

Only qualified specialists of electrical and grounding work can do these works according to "electric equipment technical standards".

Is the wiring designated for the air conditioner?

Is the remote control mounted correctly?

• In the case of exposed wiring, is the wiring fixed with the attached screw?

• Is the attached remote control clamps used for fixing the remote control cord?

• Is the remote control mounted at a height where children cannot reach?

RELOCATION

Warning : Make sure to consult a dealer or specialist if it is required to relocate and reinstall the air conditioning system.

If the air conditioning system is installed incorrectly, water leakage, electric shock and/or fire may occur. Note that an installation fee will be charged for relocation and installation.

INSPECTION MAINTENANCE

Normally the efficiency of the air conditioning system will become lower after a while, because dirt accumulates inside the system. This occurs gradually in around 3 years of use, depending on the condition of use and surrounding environment. It is thus necessary to conduct inspection maintenance in addition to regular maintenance. We recommend you to consult the dealer from whom you purchased the system and make a contract for periodical inspection. (charged).

OPERATION RANGE

CAUTION

Please use the system in the following operation range. If the system is operated outside this range, the protection controls may be activated to prevent malfunction.

Condition Operation	Room temperature	Temperature outside the room	Humidity inside the room
Cooling operation	Approximately 21 to 32°C	Approximately -5 to 43°C	Approximately 80% or less Long operation under high humidity may leads to waterdrop or smoky vapor at the supply air grille.
Dry operation	Long continuous operation under approximately 21°C may lead to malfunction due to dewfall		
Heating operation	Approximately 27°C or less	Approximately -10 to 21°C If outside air temperature becomes low, the heating efficiency is lowered and the heating becomes difficult.	

(Note) Operation range may differ depending on models .Please check the catalog.

MAINTENANCE AND INSPECTION GUIDELINE OF MAIN PARTS OF PACKAGED AIR CONDITIONER

This table indicates the details of regular inspection items and their intervals (inspection interval), and the timing of parts replacement under a normal use condition. If the equipment falls into a certain category specified by the laws and regulations of each country, conduct the maintenance and inspection according to the specified rules too. As to the preventive maintenance, the regular inspection interval is indicated as the "inspection interval," and the predicted interval of the "implementation of cleaning and

adjustment" or "implementation of parts replacement and repair" according to the result of the regular inspection is indicated as the "maintenance interval." As to the cleaning and adjustment, the timing is set to prevent the deterioration of parts and the degradation of performance. As to the parts replacement and repair after the inspection, the timing is set by estimating the operation time or use time, when the wear-out failure period is reached.

Explanation of symbols

- : Conduct the cleaning and adjustment according to the inspection result
- ▲: In case of abnormality after inspection, replace or repair the corresponding part.
- ◆: Conduct the periodic replacement (consumable components)

- : Random failure
- : Wear-out failure

Mainly indoor parts and built-in components

*The distinction between the indoor and outdoor assumes the air conditioner for a store and a multiple-air conditioner for a building. This may vary depending on the configuration of the unit, such as equipment air conditioner.

Part Name		Regular Inspection			Preventive Maintenance*															Remarks			
Part Name	Details of Inspection	Inspection Method	Criteria <Standard>	Details of Maintenance	Inspection Interval	Maintenance Interval (Used Hours/Duration)	Elapsed Years																
							1	2	3	4	5	6	7	8	9	10	11	12	13	14	15		
Structural component	Decorative panel (design part)	- Check of dirt and scratch	Visual inspection	- There should be no extreme dirt, scratches, or deformation	- Cleaning with neutral detergent, paintwork by repair coating	Every year Before the air-conditioning season	8 years																Cleaning object item
	Intake/outlet grills	- Visual check of dirt and scratch - Outlet grill louver operation check	Visual inspection	- There should be no extreme scratches or deformation	- Repair or replace it if deformed or damaged - Replace the bearing, motor, etc. when malfunctioning		8 years																Cleaning object item
	Frame, bottom plate, etc.	- Check of rust and peeling off of the heat insulation material - Check of peeling off and floating of paint coating	Visual inspection	- There should be no extreme rust or damage of heat insulation material	- If the heat insulation material is peeled off, repair and stick it - Paintwork by repair coating		8 years																Cleaning object item
	Vibration-proof rubber	- Check of deterioration and hardening of rubber	Visual and audible inspection	- Vibration insulation function should not be impaired	- Replace it when deteriorated or hardened		10 years																Cleaning object item
Ventilation system parts	Filter	- Visual check of dirt and breakage	Visual inspection	- Filter material should be seen through - There should be no breakage or deformation	- Clean it if it is dirty - Replace it if it is broken	Every week <small>Note 4</small>	5 years																Consumable components
	Fan Fan casing	- Visual check of vibration and balance - Check of dust adhesion and appearance	Visual inspection	- Should not be in an extremely vibrating condition - There should be no extreme rust or deformation	- Replace it in case of vibration and extreme unbalance - Clean with a brush or wash with water in case of extreme dust adhesion	Every year Before the air-conditioning season	13 years																Cleaning object item
	Fan motor	- Sound audibility check - Insulation resistance measurement	Audible inspection 500 V mega	- There should be no abnormal sound generation - The resistance value should be 1 MΩ or more	- When a bearing sound is loud, replace the bearing - When the resistance value is 1 MΩ or less, replace the motor		20,000 Hr																Cleaning object item
	Bearing	- Regular lubrication is required	Audible inspection	- There should be no abnormal sound generation	- Replace parts regularly		15,000 Hr																Consumable components
	Automatic louver motor	- Insulation resistance, abnormal sound generation	500 V mega, audible inspection	- The resistance value should be 1 MΩ or more, there should be no abnormal sound	- Replace it if the resistance value is 1 MΩ or less		20,000 Hr																Cleaning object item
Drain system parts	Drain pan	- Check the clogging of foreign matters and the flow of drain water - Check of peeling off and floating of paint coating	Visual inspection	- There should be no drainage clogging - There should be no abnormal rust generation and hole opening	- Cleaning of drain pan, inclination check - Repair coating or replace the drain pan depending on the problem level		Every year Before the air-conditioning season	8 years															
	Drain pump	- Check the drainage condition - Check the clogging and dirt of the water supply and drainage outlet - Insulation resistance	Visual inspection Visual inspection 500 V mega	- Should be drained normally - There should be no clogging or dirt - The resistance value should be 1 MΩ or more	- Replace it in case of drain defect - Clean it in case of clogging and dirt - Replace it if the resistance value is 1 MΩ or less	20,000 Hr																	Cleaning object item
	Dewing preventing heater	- Insulation resistance, appearance check	500 V mega, visual inspection	- The resistance value should be 1 MΩ or more, there should be no abnormality	- Replace it if the resistance value is 1 MΩ or less	20,000 Hr																	Cleaning object item
	Float switch	- Operation check	Tester	- ON-OFF should operate normally	- Replace it in case of malfunction	20,000 Hr																	Cleaning object item
Refrigerant system parts	Air heat exchanger	- Check the clogging and damage due to foreign objects - Gas leakage	Visual inspection Gas detector	- There should be no clogging or damage - No leakage should be detected	- Wash the air inflow side in case of clogging - Repair or replace it when gas leakage is detected	Every year Before the air-conditioning season	5 years																Cleaning object item Due to atmospheric dirt
	Piping in the unit	- Sympathetic vibration, contact, and corrosion of the piping in the unit - Sympathetic vibration and contact of capillary tube	Visual inspection Visual inspection	- There should be no abnormal sympathetic vibration, sound, or corrosion - There should be no abnormal sympathetic vibration or contact wear	- Replace it or readjust the piping when extremely corroded - Replace it or readjust the piping when extremely worn		20,000 Hr																Cleaning object item
	Electronic expansion valve	- Operation check - Operation sound by power on/off (pressure check)	Tactile inspection Audible and tactile inspection	- Circulation of refrigerant should be felt - There should be driving sound and temperature change	- Replace it when locking occurs		20,000 Hr																Cleaning object item
	Electromagnetic valve, four way switching valve, etc.	- Operation and insulation performances of electromagnetic valve, four way switching valve, etc. - Corrosion, abnormal sound	500 V mega Visual and audible inspection	- The resistance value should be 1 MΩ or more - There should be no abnormal sound or corrosion	- Replace it if the resistance value is 1 MΩ or less		20,000 Hr																Cleaning object item
Electric and electronic parts	Electric component box (including inverter)	- Circuit insulation resistance check - Terminal part, connector looseness check	500 V mega Driver, visual inspection	- The resistance value should be 1 MΩ or more - There should be no looseness at the connecting part - There should be no deposited foreign matter - There should be no abnormal display	- Clean with a brush in case of extreme dust adhesion - Replace it if the resistance value is 1 MΩ or less - Retighten or reinsert it if there is looseness	Every year Before the air-conditioning season	25,000 Hr																Cleaning object item
	Switching power source transformer	- Output voltage measurement	Tester	- Output voltage should be within a specified value	- Replace it if there is voltage abnormality		10 years																Cleaning object item
	Temperature sensor Humidistat	- Open, short circuit, earth, appearance check	Tester, visual inspection	- Should be of a specified resistance value - There should be no cracking or discoloration	- Replace it in case of disconnection and short circuit		5 years																Cleaning object item
	Remote control switch	- Check the controllability by the operation	Visual inspection	- LCD should display as operated	- Replace it in case of failure of the following capability of control and the display		25,000 Hr																Cleaning object item

Note 1) Random fault is an unexpected failure which occurs before the wear is progressed, within the service life of the parts and equipment. It is difficult to establish a technological measure against the random fault. At the moment, statistical handling is the only measure against the random fault.

Note 2) The elapsed year marked with * assumes the operating time as 10 hours/day and 2500 hours/year in a normal operating condition without frequent start/stop. This may vary according to the operating condition. Please check the calculation basis of the elapsed year when making a maintenance contract.

Note 3)  illustrates the estimated timing when the wear-out failure starts and how the failure rate increases as the time passes.

Note 4) The inspection timing of filter is basically every week. However, the contamination state varies depending on the type of filter and the use condition. Therefore, conduct the inspection in arbitrary cycles according to the use condition.

Explanation of symbols

- : Conduct the cleaning and adjustment according to the inspection result
- ▲: In case of abnormality after inspection, replace or repair the corresponding part.
- ◆: Conduct the periodic replacement (consumable components)

- : Random failure
- : Wear-out failure

[Mainly outdoor parts and built-in components]

*The distinction between the indoor and outdoor assumes the air conditioner for a store and a multiple-air conditioner for a building. This may vary depending on the configuration of the unit, such as equipment air conditioner.

Part Name		Regular Inspection			Preventive Maintenance*																Remarks		
Part Name	Details of Inspection	Inspection Method	Criteria <Standard>	Details of Maintenance	Inspection Interval	Maintenance Interval (Used Hours/Duration)	Elapsed Years																
							1	2	3	4	5	6	7	8	9	10	11	12	13	14	15		
Structural component	Guard, etc.	- Check of peeling off and floating of paint coating - Check of fractures and cracks of plastic parts	Visual inspection	- There should be no extreme rust generation, cracks, fracture, etc.	- Paintwork by repair coating - Replace it if there is any damage, such as cracks and fracture.	Every year Before the air-conditioning season	8 years																Cleaning object item
	Frame, bottom plate, etc.	- Check of rust and peeling off of the heat insulation material - Check of peeling off and floating of paint coating	Visual inspection	- There should be no extreme rust or damage of heat insulation material	- If the heat insulation material is peeled off, repair and stick it - Paintwork by repair coating		8 years																Cleaning object item
	Vibration-proof rubber	- Check of deterioration and hardening of rubber	Visual and audible inspection	- Vibration insulation function should not be impaired	- Replace it when deteriorated or hardened		10 years																
Ventilation system parts	Fan Fan casing	- Visual check of vibration and balance - Check of dust adhesion and appearance	Visual inspection	- Should not be in an extremely vibrating condition	- Replace it in case of vibration and extreme unbalance - Clean with a brush or wash with water in case of extreme dust adhesion	Every year Before the air-conditioning season	10 years																
	Fan motor	- Sound audibility check - Insulation resistance measurement	Audible inspection 500 V mega	- There should be no abnormal sound generation - The resistance value should be 1 MΩ or more	- When a bearing sound is loud, replace the bearing - When the resistance value is 1 MΩ or less, replace the motor		20,000 Hr																
	Bearing	- Regular lubrication is required	Audible inspection	- There should be no abnormal sound generation	- Replace parts regularly		15,000 Hr																Consumable components
Refrigerant system parts	Compressor	- Sound audibility and vibration at the start-up, operation, and stop - Insulation resistance measurement (after energizing the manufacturer designated time) - Looseness of terminals and contact of wiring	Visual, audible, and tactile inspection 500 V mega Driver, visual inspection	- There should be no abnormal sound or vibration - The resistance value should be 1 MΩ or more - There should be no looseness or contact	- Replace it if abnormal - Replace it if the resistance value is 1 MΩ or less - Retighten. Correction of wiring path	Every year Before the air-conditioning season	20,000 Hr																
	Air heat exchanger	- Check the clogging and damage due to foreign objects - Gas leakage	Visual inspection Gas detector	- There should be no clogging or damage - No leakage should be detected	- Wash the air inflow side in case of clogging - Repair or replace it when gas leakage is detected		5 years																Cleaning object item Due to atmospheric dirt
	Piping in the unit	- Sympathetic vibration, contact, and corrosion of the piping in the unit - Sympathetic vibration and contact of capillary tube	Visual inspection Visual inspection	- There should be no abnormal sympathetic vibration, sound, or corrosion - There should be no abnormal sympathetic vibration or contact wear	- Replace it or readjust the piping when extremely corroded - Replace it or readjust the piping when extremely worn		20,000 Hr																
	Electronic expansion valve	- Operation check - Operation sound by power on/off (pressure check)	Tactile inspection Audible and tactile inspection	- Circulation of refrigerant should be felt - There should be driving sound and temperature change	- Replace it when locking occurs		20,000 Hr																
	Electromagnetic valve, four way switching valve, etc.	- Operation and insulation performances of electromagnetic valve, four way switching valve, etc. - Corrosion, abnormal sound	500 V mega Visual and audible inspection	- The resistance value should be 1 MΩ or more - There should be no abnormal sound or corrosion	- Replace it if the resistance value is 1 MΩ or less		20,000 Hr																
	Container, etc.	- Corrosion of accumulator, oil separator, etc.	Visual inspection	- There should be no abnormal corrosion	- Repair coating in case of corrosion generation		20,000 Hr																
	Protection device (security parts)	Pressure shutoff device	- Operation pressure, gas leakage, insulation resistance	Pressure gauge, etc.	- Operate it at a setting value - Observe the rules specified by the laws and regulations		- Replace it if it does not operate within the permissible range of setting values	25,000 Hr															
Fusible plug		- Appearance check (swelling of fusible alloy)	Visual inspection	- The fusible alloy should be in a normal position	- Replace the device if fusible alloy is swelling out of the normal position	15,000 Hr																	

Note 1) Random fault is an unexpected failure which occurs before the wear is progressed, within the service life of the parts and equipment. It is difficult to establish a technological measure against the random fault. At the moment, statistical handling is the only measure against the random fault.

Note 2) The elapsed year marked with * assumes the operating time as 10 hours/day and 2500 hours/year in a normal operating condition without frequent start/stop. This may vary according to the operating condition. Please check the calculation basis of the elapsed year when making a maintenance contract.

Note 3) illustrates the estimated timing when the wear-out failure starts and how the failure rate increases as the time passes.

Explanation of symbols

- : Conduct the cleaning and adjustment according to the inspection result
- ▲: In case of abnormality after inspection, replace or repair the corresponding part.
- ◆: Conduct the periodic replacement (consumable components)

- : Random failure
- : Wear-out failure

Part Name		Regular Inspection		Preventive Maintenance*																	Remarks			
Part Name	Details of Inspection	Inspection Method	Criteria <Standard>	Details of Maintenance	Inspection Interval	Maintenance Interval (Used Hours/Duration)	Elapsed Years																	
							1	2	3	4	5	6	7	8	9	10	11	12	13	14		15		
Electric and electronic parts	Crankcase heater	- Conductivity check - Insulation resistance measurement - Appearance check	Tester 500 V mega Visual inspection	- It should be in a conducting state - The resistance value should be 1 MΩ or more - There should be no abnormality	- Replace it if it is not in a conducting state - Replace it if the resistance value is 1 MΩ or less	Every year Before the air-conditioning season	8 years																Consumable components	
	Anti-freezing heater	- Conductivity check - Insulation resistance, appearance check	Tester 500 V mega, visual inspection	- It should be in a conducting state - The resistance value should be 1 MΩ or more, there should be no abnormality	- Replace it if it is not in a conducting state - Replace it if the resistance value is 1 MΩ or less		20,000 Hr																	
	Electric component box (including inverter)	- Circuit insulation resistance check - Terminal part, connector looseness check	500 V mega Driver, visual inspection	- The resistance value should be 1 MΩ or more - There should be no looseness at the connecting part	- Clean with a brush in case of extreme dust adhesion - Replace it if the resistance value is 1 MΩ or less - Retighten or re-insert it if there is looseness		25,000 Hr																	
		Electrolytic capacitor	- Capacitor (electrolytic) appearance check	Visual inspection	- There should be no liquid leakage or deformation		- Appearance check, replace it if there is liquid leakage	10 years																Consumable components
	Smoothing capacitor	- Measurement of electrical capacitance and insulation resistance - Appearance check	Electrostatic instrument, 500 V mega Tester	- Should be of specified volume or more - The resistance value should be 1 MΩ or more	- Replace parts regularly - Replace it if the resistance value is 1 MΩ or less		25,000 Hr																	
	Terminal block	- Terminal part screw looseness, deposit of dirt	Driver, visual inspection	- It should not be loose - There should be no deposited foreign matter	- Retighten it if it is loose. - Clean with a brush in case of deposited foreign matter adhesion		25,000 Hr																	
	Electrical component (including boards, etc.)	- HIC board short circuit check - Visual check of dirt adhesion to the board, etc. - Self-diagnosis mode, appearance check	Tester Visual inspection Visual inspection	- Should be of a specified resistance value - There should be no deposited foreign matter - There should be no abnormal display	- Replace it if it is outside the specified resistance value - Clean with a brush in case of deposited foreign matter adhesion - Replace or correct the part		25,000 Hr																	
	Pressure sensor, temperature sensor	- Open, short circuit, earth, appearance check	Tester, visual inspection	- Should be of a specified resistance value - There should be no cracking or discoloration	- Replace it in case of disconnection and short circuit		5 years																	
	Switch, etc. (including FFB, ELB)	Electromagnetic switch	- Operation, appearance check	Visual inspection	- There should be no deformation		- Replace it in case of malfunction, deformation, and discoloration	25,000 Hr																
		Overcurrent relay Auxiliary relay, etc.	- Rough contact surface	Visual inspection	- It should operate as prescribed, there should be no deformation - There should be no deformation or discoloration			10 years																
Switching power source transformer	- Output voltage measurement	Tester	- Output voltage should be within a specified value	- Replace it if there is voltage abnormality	20,000 Hr																			
Cooling fan	- Insulation resistance, abnormal sound generation	500 V mega, audible inspection	- The resistance value should be 1 MΩ or more, there should be no abnormal sound	- Replace it if the resistance value is 1 MΩ or less - Replace it in case of fan lock	10 years																			
Fuse	- Appearance check	Visual inspection	- There should be no deformation or discoloration	- Replace it when it is shutdown	10 years																Consumable components			

Note 1) Random fault is an unexpected failure which occurs before the wear is progressed, within the service life of the parts and equipment. It is difficult to establish a technological measure against the random fault. At the moment, statistical handling is the only measure against the random fault.

Note 2) The elapsed year marked with * assumes the operating time as 10 hours/day and 2500 hours/year in a normal operating condition without frequent start/stop. This may vary according to the operating condition. Please check the calculation basis of the elapsed year when making a maintenance contract.

Note 3) illustrates the estimated timing when the wear-out failure starts and how the failure rate increases as the time passes.



AIR-CONDITIONING & REFRIGERATION DIVISION

3-1, Asahi, Nishibiwajima-cho, Kiyosu, Aichi, 452-8561, Japan
<http://www.mhi.co.jp>

mitsubishi heavy industries air-conditioning europe, ltd.

7 Roundwood Avenue, Stockley Park, Uxbridge, Middlesex, UB11 1AX, United Kingdom
Tel : +44-20-7025-2750
Fax : +44-20-7025-2751
<http://www.mhiae.com>

mitsubishi heavy industries air-conditioners australia, Pty. Ltd.

9C Commercial Road Kingsgrove NSW 2208 PO BOX 318 Kingsgrove NSW 1480
Tel : +61-2-8571-7977
Fax : +61-2-8571-7992
<http://www.mhiao.com.au>

mitsubishi heavy industries - mahajak air conditioners Co., Ltd.

220 Soi Chalongkrung 31, Kwang Lamplatiw, Khet Lad Krabang, Bangkok 10520, Thailand
Tel : +66-2-326-0401
Fax : +66-2-326-0419
<http://www.maco.co.th/>