



SERVICE MANUAL

INVERTER MULTI-SPLIT SYSTEM RESIDENTIAL AIR-CONDITIONERS (Split system, air to air heat pump type)

(OUTDOOR UNIT)

SCM71ZS-W
80ZS-W

(INDOOR UNIT)

| Wall mounted type | Ceiling concealed type | 4-way ceiling cassette type |
|--------------------|------------------------|-----------------------------|
| SRK20ZSX-W,-WB,-WT | SRR25ZM-W | FDTC25VH |
| 25ZSX-W,-WB,-WT | 35ZM-W | 35VH |
| 35ZSX-W,-WB,-WT | 50ZS-W | 50VH |
| 50ZSX-W,-WB,-WT | 60ZS-W | 60VH |
| 60ZSX-W,-WB,-WT | | |
| SRK20ZS-W,-WB,-WT | Ceiling suspended type | |
| 25ZS-W,-WB,-WT | FDE50VH | |
| 35ZS-W,-WB,-WT | | |
| 50ZS-W,-WB,-WT | | |
| SRK71ZR-W | | |

Duct connected-Low/Middle static pressure type
FDUM50VH

CONTENTS

| | |
|---|-----------|
| 1. OUTLINE OF OPERATION CONTROL BY MICROCOMPUTER | 7 |
| 1.1 SRK and SRR series | 7 |
| 1.1.1 SRK-ZSX series | 7 |
| (1) Operation control function by wireless remote control | 7 |
| (2) Unit ON/OFF button | 8 |
| (3) Auto restart function | 8 |
| (4) Installing two air-conditioners in the same room | 8 |
| (5) Selection of the annual cooling function | 9 |
| (6) Heating only function | 9 |
| (7) High power operation | 9 |
| (8) Economy operation | 10 |
| (9) Air flow direction adjustment | 10 |
| (10) 3D auto operation | 11 |
| (11) Timer operation | 12 |
| (12) Silent operation | 13 |
| (13) Night setback operation | 13 |
| (14) Air flow range setting | 13 |
| (15) Display brightness adjustment | 14 |
| (16) AUTO OFF operation | 14 |
| (17) Outline of dehumidifying (DRY) operation | 14 |
| (18) Outline of automatic operation | 15 |
| (19) Protective control function | 15 |
| 1.1.2 SRK-ZS series | 17 |
| (1) Operation control function by wireless remote control | 17 |
| (2) Unit ON/OFF button | 18 |
| (3) Auto restart function | 18 |
| (4) Installing two air-conditioners in the same room | 18 |
| (5) Selection of the annual cooling function | 19 |
| (6) Heating only function | 19 |
| (7) High power operation | 19 |
| (8) Economy operation | 20 |
| (9) Air flow direction adjustment | 20 |
| (10) 3D auto operation | 21 |

| | |
|---|-----------|
| (11) Timer operation | 22 |
| (12) Silent operation | 22 |
| (13) Night setback operation | 22 |
| (14) Air flow range setting | 23 |
| (15) Display brightness adjustment | 23 |
| (16) Outline of dehumidifying (DRY) operation | 24 |
| (17) Outline of automatic operation | 24 |
| (18) Protective control function | 25 |
| 1.1.3 SRK-ZR series | 26 |
| (1) Operation control function by wireless remote control | 26 |
| (2) Unit ON/OFF button | 27 |
| (3) Auto restart function | 27 |
| (4) Installing two air-conditioners in the same room | 27 |
| (5) Selection of the annual cooling function | 28 |
| (6) High power operation | 28 |
| (7) Economy operation | 28 |
| (8) Air flow direction adjustment | 29 |
| (9) 3D auto operation | 30 |
| (10) Timer operation | 31 |
| (11) Silent operation | 31 |
| (12) Night setback operation | 31 |
| (13) Air flow range setting | 32 |
| (14) Outline of dehumidifying (DRY) operation | 33 |
| (15) Outline of automatic operation | 33 |
| (16) Protective control function | 34 |
| 1.1.4 SRR series | 35 |
| (1) Operation control function by wireless remote control | 35 |
| (2) Unit ON/OFF button | 36 |
| (3) Auto restart function | 36 |
| (4) Installing two air-conditioners in the same room | 37 |
| (5) Selection of the annual cooling function | 37 |
| (6) High power operation | 38 |
| (7) Economy operation | 38 |
| (8) Timer operation | 39 |

| | |
|---|-----------|
| (9) Night setback operation | 39 |
| (10) Determining the operating mode | 39 |
| (11) Drain pump abnormalities detection | 39 |
| (12) Outline of dehumidifying (DRY) operation | 40 |
| (13) Outline of automatic operation | 40 |
| (14) Operation permission/prohibition control | 41 |
| (15) External control (remote display)/control of input signal | 41 |
| (16) Hot keep operation | 42 |
| (17) Frost prevention control | 42 |
| (18) Indoor fan motor protection | 42 |
| 1.2 FDTC, FDUM and FDE series | 43 |
| 1.2.1 Wired remote control (Option parts) | 43 |
| 1.2.2 Operation control function by the wired remote control | 45 |
| 1.2.3 Operation control function by the indoor control | 48 |
| (1) Auto operation | 48 |
| (2) Operations of functional items during cooling/heating | 49 |
| (3) Dehumidifying (DRY) operation | 49 |
| (4) Timer operation | 50 |
| (5) Hot start (Cold draft prevention at heating) | 51 |
| (6) Hot keep | 51 |
| (7) Auto swing control (FDTC and FDE only) | 52 |
| (8) Thermostat operation | 53 |
| (9) Filter sign | 54 |
| (10) Compressor inching prevention control | 54 |
| (11) Drain pump control | 55 |
| (12) Drain pump motor (DM) control | 55 |
| (13) Operation check/drain pump test run operation mode | 55 |
| (14) Cooling, dehumidifying frost protection | 56 |
| (15) Heating overload protection | 56 |
| (16) Anomalous fan motor | 56 |
| (17) Plural unit control - Control of 16 units group by one remote control | 57 |
| (18) High ceiling control | 57 |
| (19) Abnormal temperature sensor (return air/indoor heat exchanger) broken wire/short-circuit detection | 58 |
| (20) External input/output control (CnT or CnTA) | 58 |

| | |
|---|-----------|
| (21) Operation permission/prohibition | 60 |
| (22) Temporary stop input | 62 |
| (23) Selection of cooling/heating external input function | 62 |
| (24) Fan control at heating startup | 63 |
| (25) Room temperature detection temperature compensation during heating | 63 |
| (26) Return air temperature compensation | 63 |
| (27) High power operation (RC-EX3A only) | 63 |
| (28) Energy-saving operation (RC-EX3A only) | 63 |
| (29) Warm-up control (RC-EX3A only) | 63 |
| (30) Home leave mode (RC-EX3A only) | 63 |
| (31) Auto temperature setting (RC-EX3A only) | 63 |
| (32) Fan circulator operation (RC-EX3A only) | 64 |
| (33) The operation judgment is executed every 5 minutes (RC-EX3A only) | 64 |
| (34) Auto fan speed control (RC-EX3A only) | 64 |
| (35) Indoor unit overload alarm (RC-EX3A only) | 64 |
| (36) Peak-cut timer (RC-EX3A only) | 64 |
| (37) Motion sensor control (RC-EX3A and RCN-E2 only) | 65 |
| 1.3 Outdoor units | 67 |
| 1.3.1 Outline of heating operation | 67 |
| (1) Summary | 67 |
| (2) Operation of major functional components in heating mode | 67 |
| (3) Defrost operation | 68 |
| 1.3.2 Outline of cooling operation | 69 |
| (1) Summary | 69 |
| (2) Operation of major functional components in cooling mode | 69 |
| 1.3.3 Protective control function | 70 |
| (1) Cooling overload protective control | 70 |
| (2) Cooling high pressure control | 70 |
| (3) Cooling low outdoor temperature protective control | 71 |
| (4) Heating high pressure control | 71 |
| (5) Heating overload protective control | 72 |
| (6) Heating low outdoor temperature protective control | 72 |
| (7) Refrigeration cycle system protective control | 73 |
| (8) Service valve (gas side) closing operation | 73 |

| | |
|---|------------|
| (9) Compressor overheat protection | 74 |
| (10) Current safe | 74 |
| (11) Current cut | 75 |
| (12) Outdoor unit failure | 75 |
| (13) Discharge pipe sensor disconnection protection control | 75 |
| (14) Regulation of outdoor air flow | 76 |
| (15) Serial signal transmission error protection | 76 |
| (16) Rotor lock | 76 |
| (17) Outdoor fan motor protection | 76 |
| (18) Outdoor fan control at low outdoor temperature | 76 |
| (19) Outdoor fan control at overload | 77 |
| (20) Limit of the number of compressor starts | 78 |
| 2. MAINTENANCE DATA | 79 |
| 2.1 SRK and SRR series | 79 |
| (1) Cautions | 79 |
| (2) Items to check before troubleshooting | 79 |
| (3) Troubleshooting procedure (If the air-conditioner does not run at all) | 79 |
| (4) Troubleshooting procedure (If the air-conditioner runs) | 80 |
| (5) Self-diagnosis table | 81 |
| (6) Service mode (Trouble mode access function) | 82 |
| (7) Inspection procedures corresponding to detail of trouble | 90 |
| (8) Phenomenon observed after short-circuit, wire breakage on sensor | 95 |
| (9) Checking the indoor electrical equipment | 96 |
| (10) How to make sure of wireless remote control | 97 |
| (11) Inspection procedure for blown fuse on the indoor and outdoor unit PCB | 97 |
| (12) Outdoor unit inspection points | 98 |
| 2.2 FDTC, FDUM and FDE series | 100 |
| 2.2.1 Diagnosing of microcomputer circuit | 100 |
| (1) Selfdiagnosis function | 100 |
| (2) Troubleshooting procedure | 103 |
| (3) Troubleshooting at the indoor unit | 103 |
| (4) Troubleshooting at the outdoor unit | 107 |
| (5) Check of anomalous operation data with the remote control | 108 |
| (6) Inverter checker for diagnosis of inverter output | 110 |

| | |
|--|------------|
| (7) Outdoor unit inspection points | 110 |
| 2.2.2 Troubleshooting flow | 111 |
| (1) List of troubles | 111 |
| (2) Troubleshooting | 112 |
| 3. ELECTRICAL WIRING | 156 |
| 4. PIPING SYSTEM | 164 |

1. OUTLINE OF OPERATION CONTROL BY MICROCOMPUTER

1.1 SRK and SRR series

1.1.1 SRK-ZSX series

(1) Operation control function by wireless remote control

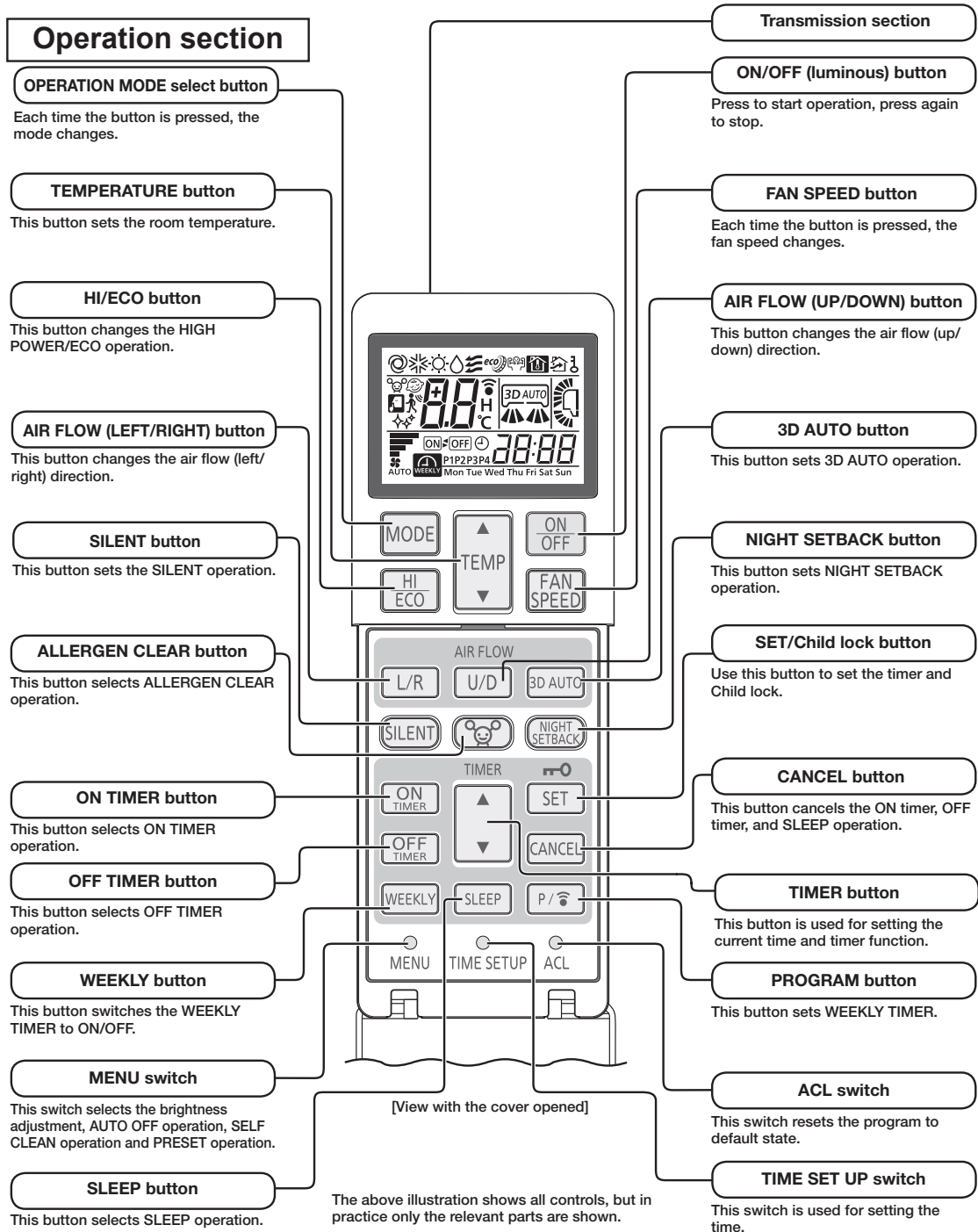

• RUN lights blink quickly during invalid operation mode.

(2) Unit ON/OFF button

When the wireless remote control batteries become weak, or if the wireless remote control is lost or malfunctioning, this button may be used to turn the unit on and off.

(a) Operation

Push the button once to place the unit in the automatic mode. Push it once more to turn the unit off.

(b) Details of operation

The unit will go into the automatic mode in which it automatically determines, from room temperature (as detected by sensor), whether to go into the COOL or HEAT modes.

| Function | Room temperature setting | Fan speed | Flap/Louver | Timer switch |
|----------------|--------------------------|-----------|-------------|--------------|
| Operation mode | | | | |
| COOL | About 24°C | Auto | Auto | Continuous |
| HEAT | About 26°C | | | |

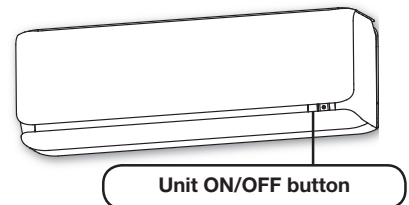

(3) Auto restart function

(a) Auto restart function records the operational status of the air-conditioner immediately prior to be switched off by a power cut, and then automatically resumes operations after the power has been restored.

(b) The following settings will be cancelled:

- (i) Timer settings
- (ii) HIGH POWER operation

- Notes
- (1) Auto restart function is set at on when the air-conditioner is shipped from the factory. Consult with your dealer if this function needs to be switched off.
 - (2) When power failure occurs, the timer setting is cancelled. Once power is resumed, reset the timer.
 - (3) If the jumper wire (J1) "AUTO RESTART" is cut, auto restart is disabled. (See the diagram at right)

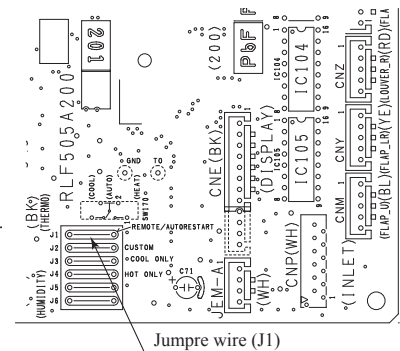

(4) Installing two air-conditioners in the same room

When two air-conditioners are installed in the room, use this setting when the two air-conditioners are not operated with one wireless remote control. Set the wireless remote control and indoor unit.

(a) Setting the wireless remote control

- (i) Pull out the cover and take out batteries.
- (ii) Disconnect the switching line next to the battery with wire cutters.
- (iii) Insert batteries. Close the cover.

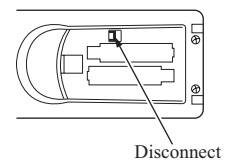

(b) Setting indoor unit

- (i) Turn off the power source, and turn it on after 1 minute.
- (ii) Point the wireless remote control (that was set according to the procedure described on the left side) at the indoor unit and send a signal by pressing the ACL switch on the wireless remote control.
Since the signal is sent in about 6 seconds after the ACL switch is pressed, point the wireless remote control at the indoor unit for some time.
- (iii) Check that the reception buzzer sound "Peep" is emitted from the indoor unit.
At completion of the setting, the indoor unit emits a buzzer sound "Peep".
(If no reception sound is emitted, start the setting from the beginning again.)

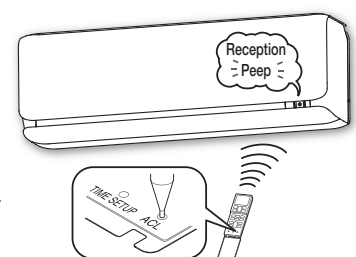

(5) Selection of the annual cooling function

- (a) The annual cooling control is valid from factory default setting. It is possible to disable by cutting jumper wire (J3), or changing the setting of DIP switch (SW2-4) on the interface kit (option) PCB if it is connected.

| Jumper wire (J3) | Interface kit (SC-BIKN2-E) SW2-4 | Function |
|------------------|----------------------------------|----------|
| Shorted | ON | Enabled |
| Shorted | OFF | Disabled |
| Open | ON | Disabled |
| Open | OFF | Disabled |

Notes (1) Default states of the jumper wire (J3) and the interface kit at the shipping from factory –On the PCB, the DIP switch (SW2-4) is set to enable the annual cooling function.

(2) To cancel the annual cooling setting, consult your dealer.

(b) Content of control

- (i) If the outdoor air temperature sensor (TH2 (Tho-A)) detects below 5°C, the indoor unit speed is switched to 8th step.
- (ii) If the outdoor air temperature sensor (TH2 (Tho-A)) detects higher than 7°C, the indoor unit speed is changed to the normal control speed.

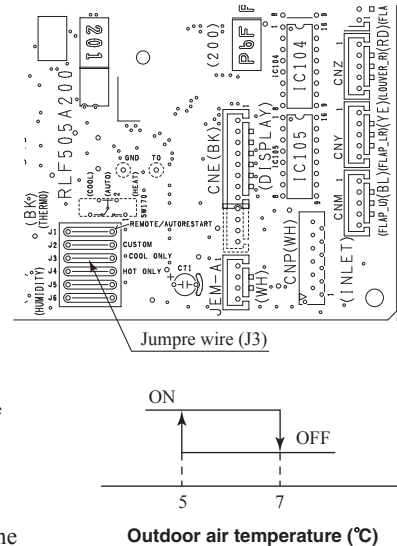

(6) Heating only function

- (a) Heating only function can be enabled by disconnecting the jumper wire (J4).
- (b) Control contents

| Operation mode setting | Operation mode |
|------------------------|----------------|
| COOL/DRY/FAN | FAN |
| AUTO/HEAT | HEAT |

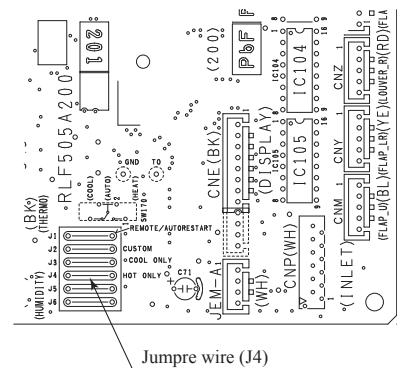

(7) High power operation

Pressing the HI/ECO button intensifies the operating power and initiates powerful cooling and heating operation for 15 minutes continuously. The wireless remote control displays HIGH POWER mark and the FAN SPEED display disappears.

- (a) During the HIGH POWER operation, the room temperature is not controlled. When it causes an excessive cooling and heating, press the HI/ECO button again to cancel the HIGH POWER operation.
- (b) HIGH POWER operation is not available during the DRY and the ON timer to OFF timer operations.
- (c) When HIGH POWER operation is set after ON timer operation, HIGH POWER operation will start from the set time.
- (d) When the following operation are set, HIGH POWER operation will be cancelled.
 - ① When the HI/ECO button is pressed again.
 - ② When the operation mode is changed.
 - ③ When it has been 15 minutes since HIGH POWER operation has started.
 - ④ When the 3D AUTO button is pressed.
 - ⑤ When the SILENT button is pressed.
 - ⑥ When the NIGHT SETBACK button is pressed.
- (e) Not operable while the air-conditioner is OFF.
- (f) After HIGH POWER operation, the sound of refrigerant flowing may be heard.

(8) Economy operation

- (a) Pressing the HI/ECO button initiates a soft operation with the power suppressed in order to avoid an excessive cooling or heating.
- (b) The remote control  displays.
- (c) The set temperature will be adjusted according to the amount of movement made by the person(s) the motion sensor has detected.

MODE:AUTO mode operation

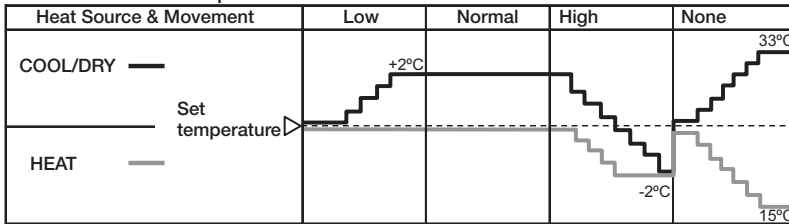

| | |
|-------------|--|
| Low | When the extent of human movement is low |
| High | When the extent of human movement is high |
| None | When there is no one in the room |

MODE:COOL/HEAT/DRY mode operation

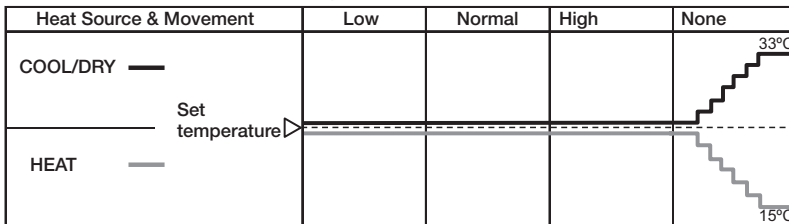

- The set temperature is automatically adjusted during economy operation, however, the indication on the remote control display does not change.
- When the SLEEP TIMER, OFF TIMER, and ON TIMER + OFF TIMER operation are set, the motion sensor does not adjust temperatures.
- When the “None” continues for 1 hour, the FAN SPEED is set UL0.

Notes (1) It will go into economy operation at the next time the air-conditioner runs in the following case.

- ① When the air-conditioner is stopped by ON/OFF button during economy operation.
 - ② When the air-conditioner is stopped in SLEEP or OFF TIMER operation during economy operation.
 - ③ When the operation is retrieved from SELF CLEAN or ALLERGEN CLEAR operation.
- (2) When the following operations are set, economy operation will be canceled.
- ① When the HI/ECO button is pressed again.
 - ② When the operation mode is changed from DRY to FAN.
 - ③ When the NIGHT SETBACK button is pressed.
- (3) Not operable while the air-conditioner is OFF.

(9) Air flow direction adjustment



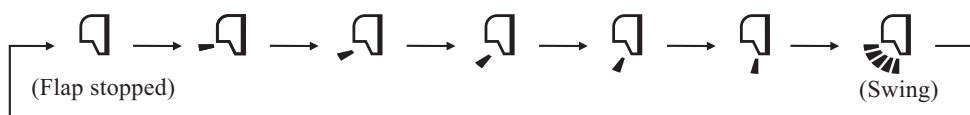

Air flow direction can be adjusted with by AIR FLOW U/D (UP/DOWN) and L/R (LEFT/RIGHT) button on the wireless remote control.

(a) Flap

Every time when you press the AIR FLOW U/D (UP/DOWN) button the mode changes as follows



• Angle of flap from horizontal

| Wireless remote control display |  |  |  |  |  |
|---------------------------------|---|---|---|---|---|
| COOL, DRY, FAN | Approx. 15° | Approx. 20° | Approx. 25° | Approx. 30° | Approx. 55° |
| HEAT | Approx. 30° | Approx. 40° | Approx. 45° | Approx. 50° | Approx. 55° |

(b) Louver

Every time when you press the AIR FLOW L/R (LEFT/RIGHT) button the mode changes as follows

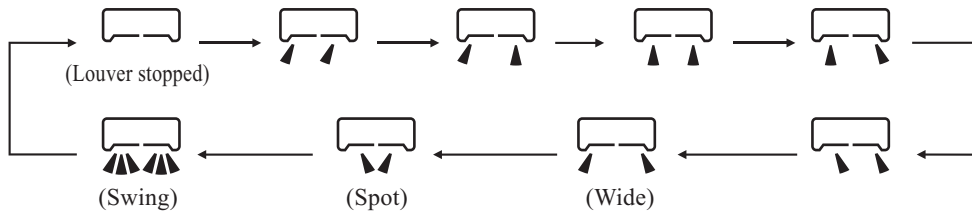

• Angle of louver

| Wireless remote control display | | | | | |
|---------------------------------|------------------|------------------|-------------------|-------------------|-------------------|
| Center installation | Left approx. 50° | Left approx. 20° | Center | Right approx. 20° | Right approx. 50° |
| Right end installation | Left approx. 50° | Left approx. 45° | Left approx. 30° | Center | Right approx. 20° |
| Left end installation | Left approx. 20° | Center | Right approx. 30° | Right approx. 45° | Right approx. 50° |

(c) Swing

(i) Swing flap

Flap moves in upward and downward directions continuously.

(ii) Swing louver

Louver moves in left and right directions continuously.

◆ In COOL, DRY, FAN operation

◆ In HEAT operation

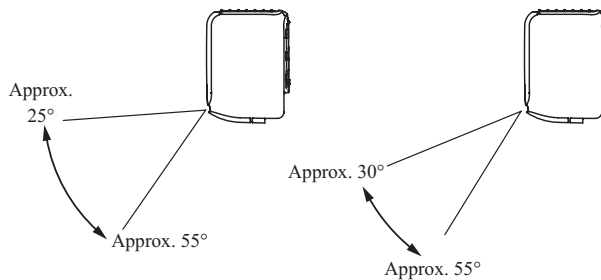

(d) Memory flap (Flap or louver stopped)

When you press the AIR FLOW (UP/DOWN or LEFT/RIGHT) button once while the flap or louver is operating, it stops swinging at the position. Since this angle is memorized in the microcomputer, the flap or louver will automatically be set at this angle when the next operation is started.

(10) 3D auto operation

Control the flap and louver by 3D AUTO button on the wireless remote control.

Fan speed and air flow direction are automatically controlled, allowing the entire indoor to efficiently conditioned.

(a) During cooling and heating operation (Including auto cooling and heating operation)

(i) Air flow selection is determined according to indoor temperature and setting temperature.

| Operation mode | Air flow selection | | | | |
|----------------|---------------------------------|----------------------------------|----|-----|----|
| | AUTO | | HI | MED | LO |
| Cooling | Room temp. – Setting temp. >5°C | Room temp. – Setting temp. ≤ 5°C | HI | MED | LO |
| | HIGH POWER | AUTO | | | |
| Heating | Setting temp. – Room temp. >5°C | Setting temp. – Room temp. ≤ 5°C | | | |
| | HIGH POWER | AUTO | | | |

(ii) Air flow direction is controlled according to the room temperature and setting temperature.

1) When 3D auto operation starts

| | Cooling | Heating |
|---------------|---------------|----------------|
| Flap | Up/down swing | |
| Louver | Wide (Fixed) | Center (Fixed) |

2) When Room temp. – Setting temp. is $\leq 5^{\circ}\text{C}$ during cooling and when Setting temp. – Room temp. is $\leq 5^{\circ}\text{C}$ during heating, the system switches to the following air flow direction control. After the louver swings left and right symmetrically for 3 cycles, control is switched to the control in 3).

| | Cooling | Heating |
|---------------|----------------------------|--------------------------------|
| Flap | Horizontal blowing (Fixed) | Slant forwardl blowing (Fixed) |
| Louver | Left/right swing | |

3) After the flap swings for 5 cycles, control is switched to the control in 4).

| | Cooling | Heating |
|---------------|----------------|---------|
| Flap | Up/down swing | |
| Louver | Center (Fixed) | |

4) For 5 minutes, the following air flow direction control is carried out.

| | Cooling | Heating |
|---------------|----------------------------|--------------------------------|
| Flap | Horizontal blowing (Fixed) | Slant forwardl blowing (Fixed) |
| Louver | Wide (Fixed) | |

5) After 5 minutes have passed, the air flow direction is determined according to the room temperature and setting temperature.

| Operation mode | Air flow direction control | | |
|----------------|---|--|--|
| Cooling | Room temp. – Setting temp. $\leq 2^{\circ}\text{C}$ | $2^{\circ}\text{C} < \text{Room temp. – Setting temp.} \leq 5^{\circ}\text{C}$ | Room temp. – Setting temp. $> 5^{\circ}\text{C}$ |
| | The control in 4) continues. | Control returns to the control in 2). | Control returns to the control in 1). |
| Heating | Setting temp. – Room temp. $\leq 2^{\circ}\text{C}$ | $2^{\circ}\text{C} < \text{Setting temp. – Room temp.} \leq 5^{\circ}\text{C}$ | Setting temp. – Room temp. $> 5^{\circ}\text{C}$ |
| | The control in 4) continues. | Control returns to the control in 2). | Control returns to the control in 1). |

(b) During DRY operation (including auto DRY operation)

| | |
|---------------|----------------------------|
| Flap | Horizontal blowing (Fixed) |
| Louver | Wide (Fixed) |

(11) Timer operation

(a) Comfort start-up (ON timer operation)

The unit starts the operation 5 to 60 minutes earlier so that the room can approach optimum temperature at ON timer.

(b) Sleep timer operation

Pressing the SLEEP button causes the temperature to be controlled with respect to the set temperature.

(c) OFF timer operation

The OFF timer can be set at a specific time (in 10-minute units) within a 24-hour period.

(d) Weekly timer operation

Up to 4 programs with timer operation (ON timer / OFF timer) are available for each day of the week.

Note (1) Timer operation from wireless remote control becomes invalid when you connect the interface kit (such as SC-BIKN2-E).

(12) Silent operation

When the silent operation is set, the unit operates by dropping the outdoor fan speed and the compressor speed.

| | SCM71 | | SCM80 | |
|---------------------------------|-----------|-----------|-----------|-----------|
| | Cooling | Heating | Cooling | Heating |
| Outdoor fan speed (Upper limit) | 4th speed | 4th speed | 4th speed | 4th speed |
| Compressor speed (Upper limit) | 40 rps | 55 rps | 45 rps | 60 rps |

(13) Night setback operation

When the night setback operation is set, the heating operation starts with the setting temperature at 10°C.

(14) Air flow range setting

Take the air-conditioner location into account and adjust the left/right air flow range to maximize air-conditioning.

(a) Setting

- (i) If the air-conditioner is running, press the ON/OFF button to stop.
The air flow range setting cannot be made while the unit is running.

- (ii) Press the AIR FLOW U/D (UP/DOWN) button and the AIR FLOW L/R (LEFT/RIGHT) button together for 5 seconds or more.

The air flow range setting display illuminates.

- (iii) Setting the air flow range.

Press the AIR FLOW L/R (LEFT/RIGHT) button and adjust to the desired location.

Each time the AIR FLOW L/R (LEFT/RIGHT) button is pressed, the display is switched in the order of:

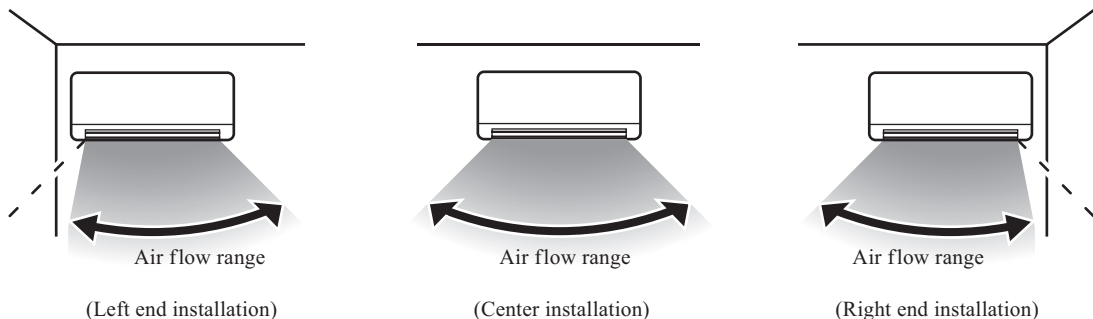
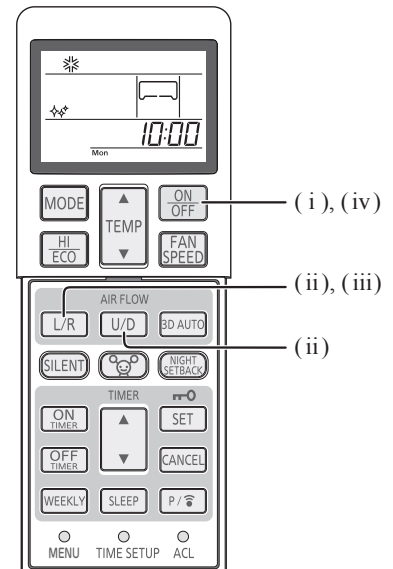

- (iv) Press the ON/OFF button.

The air-conditioner's air flow range is set.

Press within 60 seconds of setting the air flow range (while the air flow range setting display illuminates).

(15) Display brightness adjustment

This function can be used when it is necessary to adjust the brightness of unit display.

| Brightness level | Run light | Timer light |
|------------------|-----------|-------------|
| LV2 | 100% | 100% |
| LV1 | 50% | 50% |
| LV0 | 0% | 0% |

Note (1) When the unit displays self diagnosis or service mode, brightness level is always LV2.

(16) AUTO OFF operation

In order to prevent the air-conditioner from continuing to operate although the person(s) has already left the room, the air-conditioner automatically stops approximately 1 hour (or 2 hours) after the sensor judges that there is no one in the room.

- Emits a warning sound, “Peep, Peep, Peep”, and stops the operation automatically when there is no one in the room for setting time (Standby). When the motion sensor detects a person 12 hours after the operation was stopped, the operation resumes with the same settings. The operation does not resume even if a person is detected after 12 hours has elapsed. (The RUN light blinks slowly during standby.)
- When the SLEEP TIMER, OFF TIMER and ON TIMER + OFF TIMER operation are set, the AUTO OFF functions is disabled.
- The AUTO OFF function does not activate if the operation is started by the ON TIMER when there is no one at home.

(17) Outline of dehumidifying (DRY) operation**(a) Purpose of DRY mode**

The purpose is "Dehumidification", and not to control the humidity to the target condition. Indoor/outdoor unit control the operation condition to reduce the humidity, and also prevent over cooling.

(b) Outline of control

- Indoor unit fan speed and compressor are controlled by the area which is selected by the temperature difference.

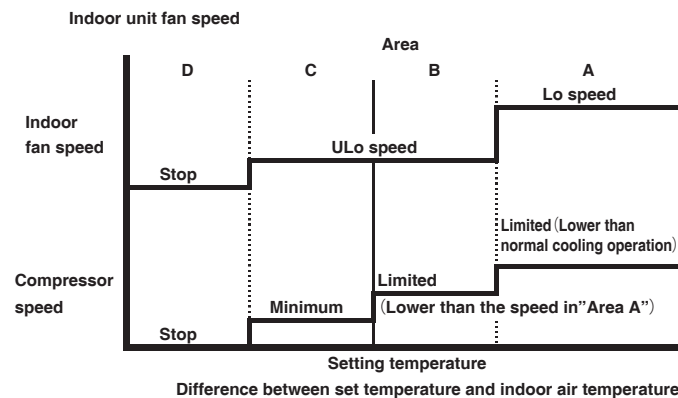

- The indoor unit check the current area by every 5 minutes, and operate by the next checking.

(c) Other

When the outdoor air temperature and room temperature is low in cooling operation, indoor unit can not operate in cooling, and dehumidify. In this case, the units operate in heating to rise the indoor air temperature and after that start DRY operation.

(18) Outline of automatic operation

(a) Determination of operation mode

Operation mode is determined by indoor air temperature and outdoor air temperature as following.

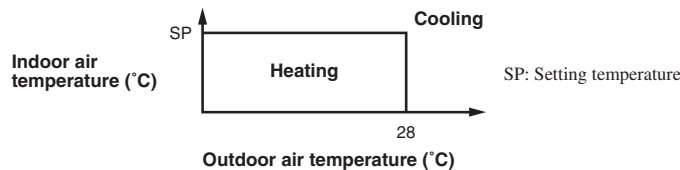

(b) Operation mode is changes when keep cooling and heating thermostat off 20 minutes and be satisfied following conditions. If the setting temperature is changed with the remote control, the operation mode is judged immediately.

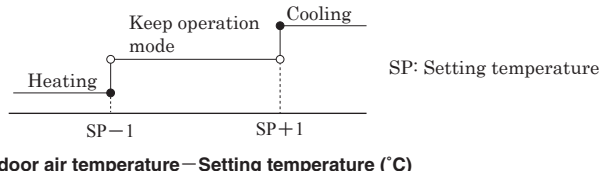

※It can not be changed to heating mode if outdoor air temperature is 28°C or higher.

- (c) When the unit is started again within one hour after the stop of automatic operation or when the automatic operation is selected during heating, cooling or dehumidifying operation, the unit is operated in the previous operation mode.
- (d) Setting temperature can be adjusted within the following range. There is the relationship as shown below between the signals of the wireless remote control and the setting temperature.

| | | Signals of wireless remote control (Display) | | | | | | | | | | | | | Unit : °C |
|---------------------|---------|--|----|----|----|----|----|----|----|----|----|----|----|----|-----------|
| | | 18 | 19 | 20 | 21 | 22 | 23 | 24 | 25 | 26 | 27 | 28 | 29 | 30 | |
| Setting temperature | Cooling | 18 | 19 | 20 | 21 | 22 | 23 | 24 | 25 | 26 | 27 | 28 | 29 | 30 | |
| | Heating | 18 | 19 | 20 | 21 | 22 | 23 | 24 | 25 | 26 | 27 | 28 | 29 | 30 | |

(19) Protective control function

(a) **Dew prevention control [Cooling]**

Prevents dewing on the indoor unit.

(i) Operating conditions

When the following conditions have been satisfied for more than 30 minutes after starting operation

- 1) The compressor is ON.
- 2) Detected value of humidity is 68% (models SRK50, 60: 60%) or higher.

(ii) Contents of operation

- 1) Air capacity control

| Item | Model | SRK20, 25ZSX-W | SRK35ZSX-W | SRK50, 60ZSX-W |
|-------------------|------------|-------------------------------|------------|----------------|
| | Indoor fan | ULO | 4th speed | |
| AUTO, HI, MED, LO | | Adaptable to compressor speed | | |

- 2) When this control has continued for more than 30 minutes continuously, the following wind direction control is performed.
 - a) When the vertical wind direction is set at other than the vertical swing, the flaps change to the horizontal position.
 - b) When the horizontal wind direction is set at other than the horizontal swing, the louver changes to the vertical position.

(iii) Reset condition

Humidity is less than 63% (models SRK50, 60: 55%).

(b) Frost prevention control (During cooling or dehumidifying)

(i) Operating conditions

- 1) Indoor heat exchanger temperature (Th2) is lower than 5°C.
- 2) 5 minutes after reaching the compressor speed except 0 rps.

(ii) Detail of anti-frost operation

| Item | Indoor heat exchanger temperature | |
|---------------------------------|-------------------------------------|--|
| | 5°C or lower | 2.5°C or lower |
| Compressor command speed | Reduced by 4 rps at each 20 seconds | 0 rps |
| Indoor fan | Depends on operation mode | Keep the fan speed before frost prevention control |
| Outdoor fan | Depends on compressor speed | Depends on stop mode |
| 4-way valve | OFF | |

- Notes
- (1) When the indoor heat exchanger temperature is in the range of 2.5–5°C, the speed is reduced by 4 rps at each 20 seconds.
 - (2) When the temperature is lower than 2.5°C, the compressor is stopped.
 - (3) When the indoor heat exchanger temperature is in the range of 5–8°C, the compressor speed is been maintained.

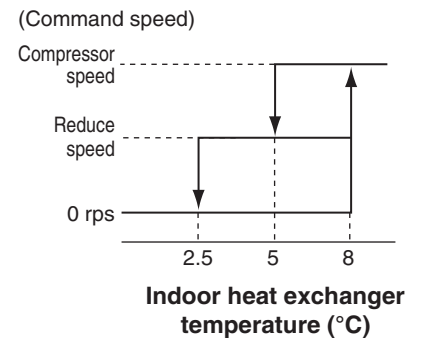

(iii) Reset conditions

When either of the following condition is satisfied.

- 1) The indoor heat exchanger temperature (Th2) is 8°C or higher.
- 2) The compressor command speed is 0 rps.

(c) Indoor fan motor protection

When the air-conditioner is operating and the indoor fan motor is turned ON, if the indoor fan motor has operated at 300 min⁻¹ or under for more than 30 seconds, the unit enters first in the stop mode and then stops the entire system.

1.1.2 SRK-ZS series

(1) Operation control function by wireless remote control

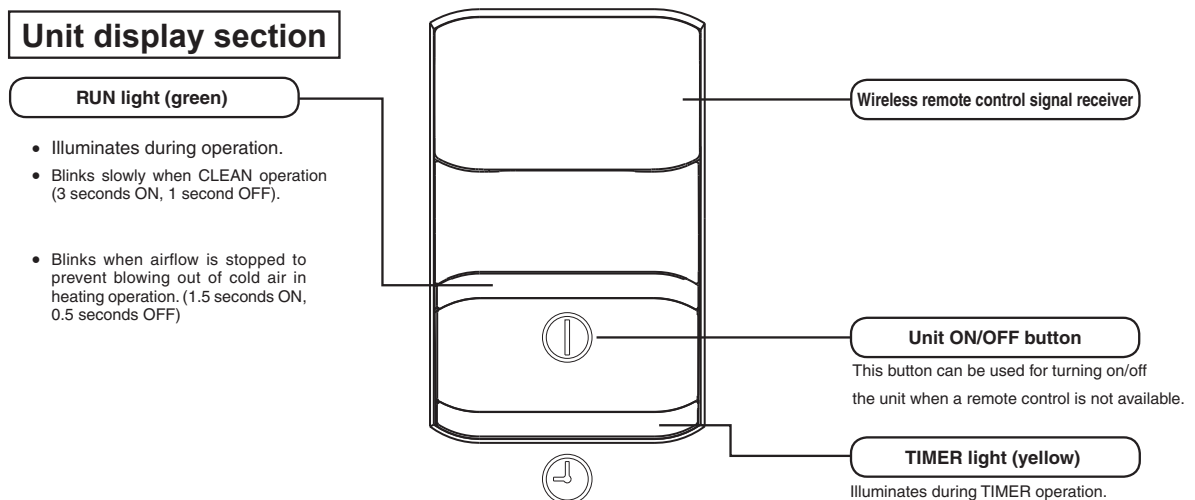
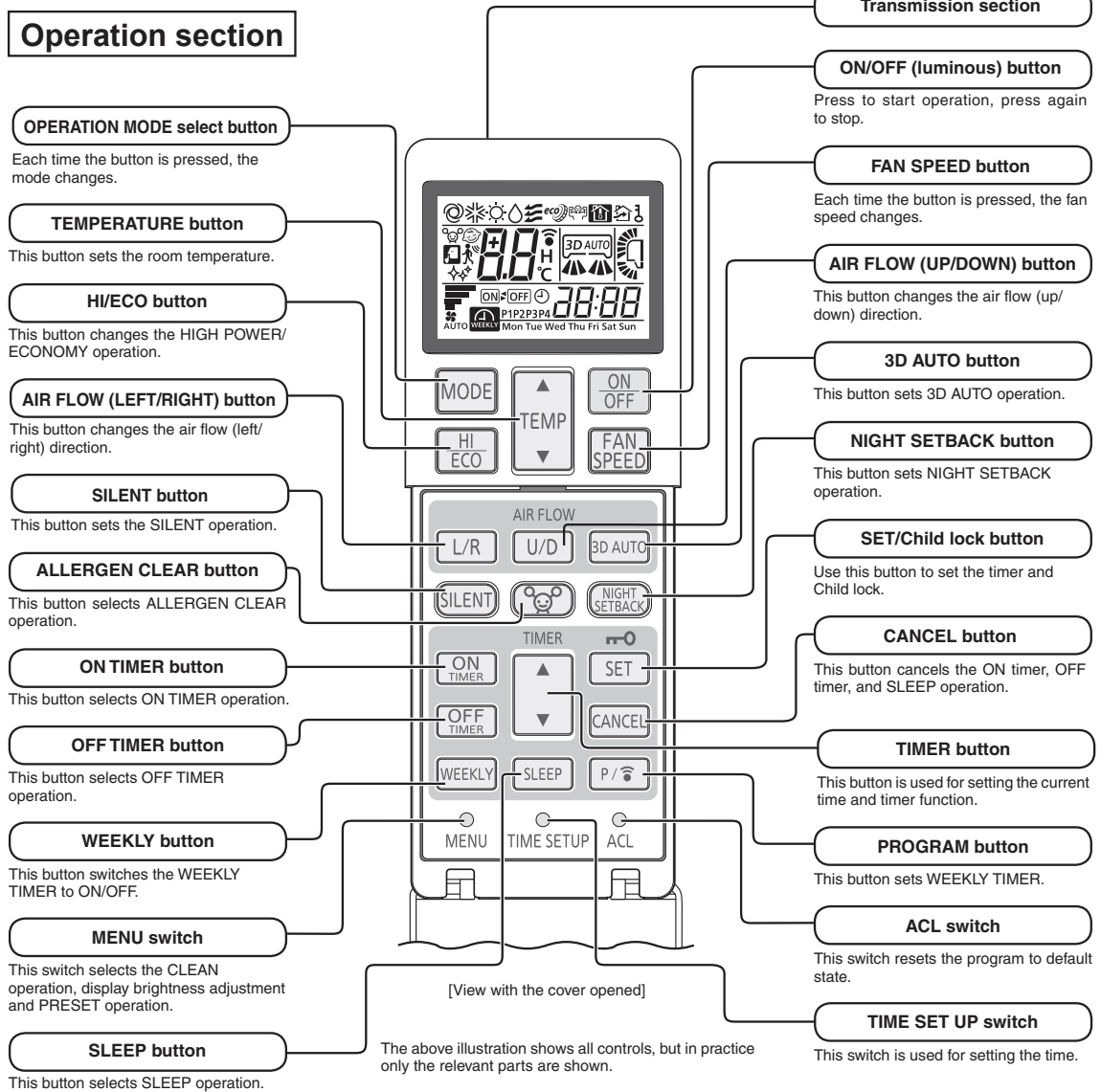

• RUN and TIMER lights blink quickly during invalid operation mode.

(2) Unit ON/OFF button

When the wireless remote control batteries become weak, or if the wireless remote control is lost or malfunctioning, this button may be used to turn the unit on and off.

(a) Operation

Push the button once to place the unit in the automatic mode. Push it once more to turn the unit off.

(b) Details of operation

The unit will go into the automatic mode in which it automatically determines, from room temperature (as detected by sensor), whether to go into the COOL or HEAT modes.

| Function Operation mode | Room temperature setting | Fan speed | Flap/Louver | Timer switch |
|----------------------------|-----------------------------|-----------|-------------|--------------|
| COOL | About 24°C | Auto | Auto | Continuous |
| HEAT | About 26°C | | | |

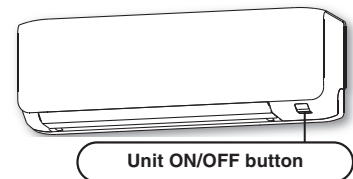

(3) Auto restart function

(a) Auto restart function records the operational status of the air-conditioner immediately prior to be switched off by a power cut, and then automatically resumes operations after the power has been restored.

(b) The following settings will be cancelled:

- (i) Timer settings
- (ii) HIGH POWER operation

- Notes
- (1) Auto restart function is set at on when the air-conditioner is shipped from the factory. Consult with your dealer if this function needs to be switched off.
 - (2) When power failure occurs, the timer setting is cancelled. Once power is resumed, reset the timer.
 - (3) If the jumper wire (J1) "AUTO RESTART" is cut, auto restart is disabled. (See the diagram at right)

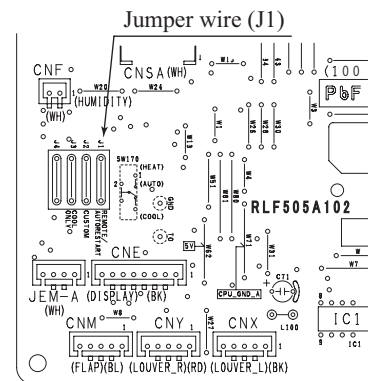

(4) Installing two air-conditioners in the same room

When two air-conditioners are installed in the room, use this setting when the two air-conditioners are not operated with one wireless remote control. Set the wireless remote control and indoor unit.

(a) Setting the wireless remote control

- (i) Pull out the cover and take out batteries.
- (ii) Disconnect the switching line next to the battery with wire cutters.
- (iii) Insert batteries. Close the cover.

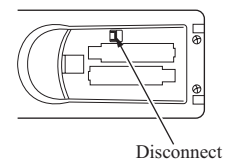

(b) Setting an indoor unit

- (i) Turn off the power source, and turn it on after 1 minute.
- (ii) Point the wireless remote control (that was set according to the procedure described on the left side) at the indoor unit and send a signal by pressing the ACL switch on the wireless remote control.
Since the signal is sent in about 6 seconds after the ACL switch is pressed, point the wireless remote control at the indoor unit for some time.
- (iii) Check that the reception buzzer sound "Peep" is emitted from the indoor unit.
At completion of the setting, the indoor unit emits a buzzer sound "Peep".
(If no reception sound is emitted, start the setting from the beginning again.)

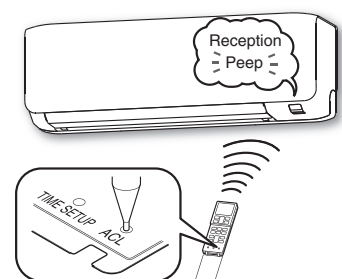

(5) Selection of the annual cooling function

- (a) The annual cooling control is valid from factory default setting. It is possible to disable by cutting jumper wire (J3), or changing the setting of DIP switch (SW2-4) on the interface kit (option) PCB if it is connected.

| Jumper wire (J3) | Interface kit (SC-BIKN2-E) SW2-4 | Function |
|------------------|----------------------------------|----------|
| Shorted | ON | Enabled |
| Shorted | OFF | Disabled |
| Open | ON | Disabled |
| Open | OFF | Disabled |

Notes (1) Default states of the jumper wire (J3) and the interface kit at the shipping from factory – On the PCB, the DIP switch (SW2-4) is set to enable the annual cooling function.

(2) To cancel the annual cooling setting, consult your dealer.

(b) Content of control

- (i) If the outdoor air temperature sensor (TH2 (Tho-A)) detects below 5°C, the indoor unit speed is switched to 7th step.
- (ii) If the outdoor air temperature sensor (TH2 (Tho-A)) detects higher than 10°C, the indoor unit speed is changed to the normal control speed.

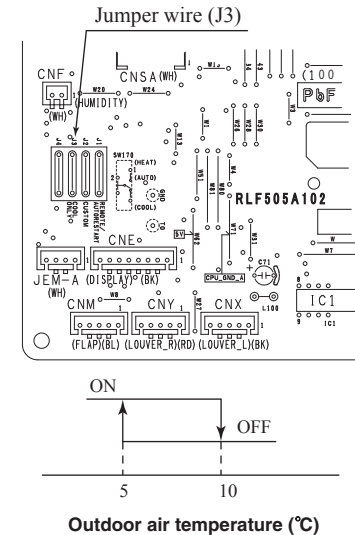
**(6) Heating only function**

- (a) Heating only function can be enabled by disconnecting the jumper wire (J4).
- (b) Control contents

| Operation mode setting | Operation mode |
|------------------------|----------------|
| COOL/DRY/FAN | FAN |
| AUTO/HEAT | HEAT |

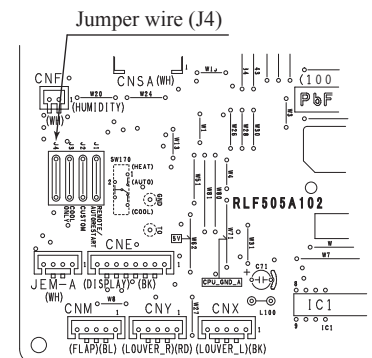
**(7) High power operation**

Pressing the HI POWER/ECONOMY button intensifies the operating power and initiates powerful cooling and heating operation for 15 minutes continuously. The wireless remote control displays HIGH POWER mark and the FAN SPEED display disappears.

- (a) During the HIGH POWER operation, the room temperature is not controlled. When it causes an excessive cooling and heating, press the HI POWER/ECONOMY button again to cancel the HIGH POWER operation.
- (b) HIGH POWER operation is not available during the DRY and the ON timer to OFF timer operations.
- (c) When HIGH POWER operation is set after ON timer operation, HIGH POWER operation will start from the set time.
- (d) When the following operation are set, HIGH POWER operation will be cancelled.
- ① When the HI POWER/ECONOMY button is pressed again.
 - ② When the operation mode is changed.
 - ③ When it has been 15 minutes since HIGH POWER operation has started.
 - ④ When the 3D AUTO button is pressed.
 - ⑤ When the SILENT button is pressed.
 - ⑥ When the NIGHT SETBACK button is pressed.
- (e) Not operable while the air-conditioner is OFF.
- (f) After HIGH POWER operation, the sound of refrigerant flowing may be heard.

(8) Economy operation

Pressing the HI POWER/ECONOMY button initiate a soft operation with the power suppressed in order to avoid an excessive cooling or heating. The unit operate 1.5°C higher than the setting temperature during cooling or 2.5°C lower than that during heating. The wireless remote control displays ECONOMY mark and the FAN SPEED display disappears.

- (a) It will go into ECONOMY operation at the next time the air-conditioner runs in the following cases.
 - ① When the air-conditioner is stopped by ON/OFF button during ECONOMY operation.
 - ② When the air-conditioner is stopped in SLEEP or OFF TIMER operation during ECONOMY operation.
 - ③ When the operation is retrieved from CLEAN or ALLERGEN CLEAR operation.
- (b) When the following operation are set, ECONOMY operation will be cancelled.
 - ① When the HI POWER/ECONOMY button is pressed again.
 - ② When the operation mode is changed from DRY to FAN.
 - ③ When the NIGHT SETBACK button is pressed.
- (c) Not operable while the air-conditioner is OFF.
- (d) The setting temperature is adjusted according to the following table.

| Item \ Mode | Cooling | Heating |
|------------------------|---------|---------|
| Temperature adjustment | ① +0.5 | ① -1.0 |
| | ② +1.0 | ② -2.0 |
| | ③ +1.5 | ③ -2.5 |

- ① at the start of operation.
- ② one hour after the start of operation.
- ③ two hours after the start of operation.

(9) Air flow direction adjustment



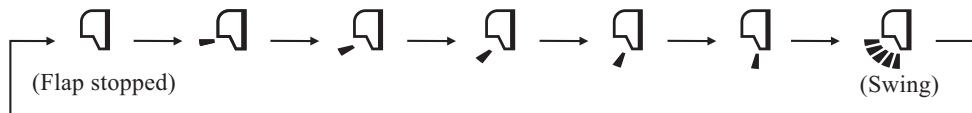

Air flow direction can be adjusted with by AIR FLOW  (UP/DOWN) and  (LEFT/RIGHT) button on the wireless remote control.

(a) Flap

Every time when you press the AIR FLOW  (UP/DOWN) button the mode changes as follows.



• Angle of flap from horizontal



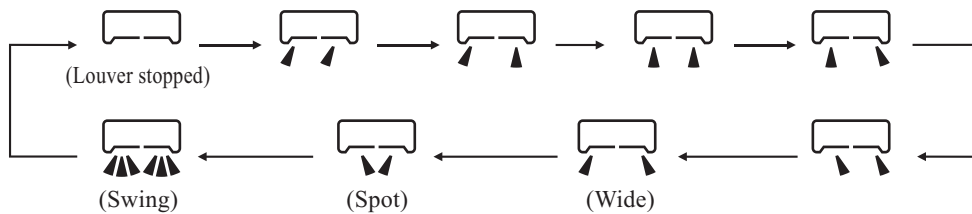

| Wireless remote control display |  |  |  |  |  |
|---------------------------------|---|---|---|---|---|
| COOL, DRY, FAN | Approx. 25° | Approx. 30° | Approx. 40° | Approx. 50° | Approx. 60° |
| HEAT | Approx. 25° | Approx. 35° | Approx. 50° | Approx. 60° | Approx. 70° |

(b) Louver

Every time when you press the AIR FLOW  (LEFT/RIGHT) button the mode changes as follows.



• Angle of louver

| Wireless remote control display |  |  |  |  |  |
|---------------------------------|---|---|---|---|---|
| Center installation | Left approx. 50° | Left approx. 20° | Center | Right approx. 20° | Right approx. 50° |
| Right end installation | Left approx. 50° | Left approx. 45° | Left approx. 30° | Center | Right approx. 20° |
| Left end installation | Left approx. 20° | Center | Right approx. 30° | Right approx. 45° | Right approx. 50° |

(c) Swing

(i) Swing flap

Flap moves in upward and downward directions continuously.

◆ In COOL, DRY, FAN operation

◆ In HEAT operation

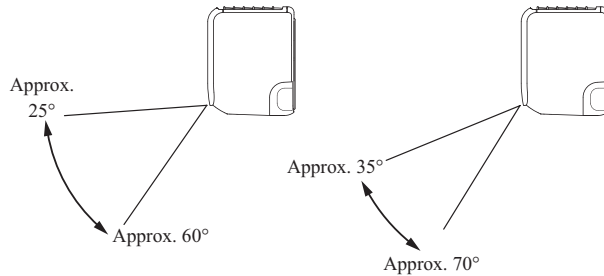

(ii) Swing louver

Louver moves in left and right directions continuously.



(d) Memory flap (Flap or louver stopped)

When you press the AIR FLOW (UP/DOWN or LEFT/RIGHT) button once while the flap or louver is operating, it stops swinging at the position. Since this angle is memorized in the microcomputer, the flap or louver will automatically be set at this angle when the next operation is started.

(10) 3D auto operation

Control the flap and louver by 3D AUTO button on the wireless remote control.

Fan speed and air flow direction are automatically controlled, allowing the entire indoor to efficiently conditioned.

(a) During cooling and heating (Including auto cooling and heating)

(i) Air flow selection is determined according to indoor temperature and setting temperature.

| Operation mode | Air flow selection | | | | |
|----------------|---------------------------------|----------------------------------|----|-----|----|
| | AUTO | | HI | MED | LO |
| Cooling | Room temp. – Setting temp. >5°C | Room temp. – Setting temp. ≤ 5°C | HI | MED | LO |
| | HIGH POWER | AUTO | | | |
| Heating | Setting temp. – Room temp. >5°C | Setting temp. – Room temp. ≤ 5°C | HI | MED | LO |
| | HIGH POWER | AUTO | | | |

(ii) Air flow direction is controlled according to the room temperature and setting temperature.

1) When 3D auto operation starts

| | Cooling | Heating |
|--------|---------------|----------------|
| Flap | Up/down swing | |
| Louver | Wide (Fixed) | Center (Fixed) |

2) When Room temp. – Setting temp. is ≤ 5°C during cooling and when setting temp. – Room temp. is ≤ 5°C during heating, the system switches to the following air flow direction control. After the louver swings left and right symmetrically for 3 cycles, control is switched to the control in 3).

| | Cooling | Heating |
|--------|----------------------------|--------------------------------|
| Flap | Horizontal blowing (Fixed) | Slant forwardl blowing (Fixed) |
| Louver | Left/right swing | |

3) After the flap swings for 5 cycles, control is switched to the control in 4).

| | Cooling | Heating |
|--------|----------------|---------|
| Flap | Up/down swing | |
| Louver | Center (Fixed) | |

- 4) For 5 minutes, the following air flow direction control is carried out.

| | Cooling | Heating |
|---------------|----------------------------|--------------------------------|
| Flap | Horizontal blowing (Fixed) | Slant forwardl blowing (Fixed) |
| Louver | Wide (Fixed) | |

- 5) After 5 minutes have passed, the air flow direction is determined according to the room temperature and setting temperature.

| Operation mode | Air flow direction control | | |
|----------------|---|--|--|
| Cooling | Room temp. – Setting temp. $\leq 2^{\circ}\text{C}$ | $2^{\circ}\text{C} < \text{Room temp. – Setting temp.} \leq 5^{\circ}\text{C}$ | Room temp. – Setting temp. $> 5^{\circ}\text{C}$ |
| | The control in 4) continues. | Control returns to the control in 2). | Control returns to the control in 1). |
| Heating | Setting temp. – Room temp. $\leq 2^{\circ}\text{C}$ | $2^{\circ}\text{C} < \text{Setting temp. – Room temp.} \leq 5^{\circ}\text{C}$ | Setting temp. – Room temp. $> 5^{\circ}\text{C}$ |
| | The control in 4) continues. | Control returns to the control in 2). | Control returns to the control in 1). |

- (b) During DRY operation (including auto DRY operation)

| | |
|---------------|----------------------------|
| Flap | Horizontal blowing (Fixed) |
| Louver | Wide (Fixed) |

(11) Timer operation

(a) Comfort start-up (ON timer operation)

The unit starts the operation 5 to 60 minutes earlier so that the room can approach optimum temperature at ON timer.

(b) Sleep timer operation

Pressing the SLEEP button causes the temperature to be controlled with respect to the set temperature.

(c) OFF timer operation

The OFF timer can be set at a specific time (in 10-minute units) within a 24-hour period.

(d) Weekly timer operation

Up to 4 programs with timer operation (ON timer / OFF timer) are available for each day of the week.

Note (1) Timer operation from wireless remote control becomes invalid when you connect the interface kit (such as SC-BIKN2-E).

(12) Silent operation

When the silent operation is set, the unit operates by dropping the outdoor fan speed and the compressor speed.

| | SCM71 | | SCM80 | |
|--|-----------|-----------|-----------|-----------|
| | Cooling | Heating | Cooling | Heating |
| Outdoor fan speed (Upper limit) | 4th speed | 4th speed | 4th speed | 4th speed |
| Compressor speed (Upper limit) | 40 rps | 55 rps | 45 rps | 60 rps |

(13) Night setback operation

When the night setback operation is set, the heating operation starts with the setting temperature at 10°C .

(14) Air flow range setting

Take the air-conditioner location into account and adjust the left/right air flow range to maximize air-conditioning.

(a) Setting

(i) If the air-conditioning unit is running, press the ON/OFF button to stop.
The installation location setting cannot be made while the unit is running.

(ii) Press the AIR FLOW U/D (UP/DOWN) button and the AIR FLOW L/R (LEFT/RIGHT) button together for 5 seconds or more.

The installation location display illuminates.

(iii) Setting the air-conditioning installation location.

Press the AIR FLOW L/R (LEFT/RIGHT) button and adjust to the desired location.

Each time the AIR FLOW L/R (LEFT/RIGHT) button is pressed, the indicator is switched in the order of:

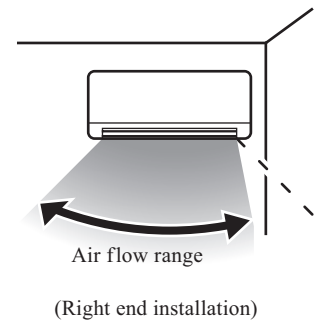
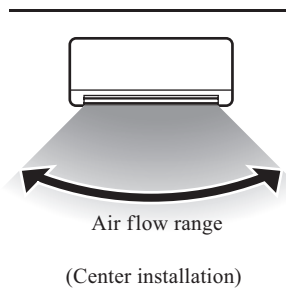
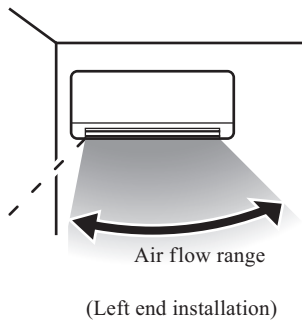
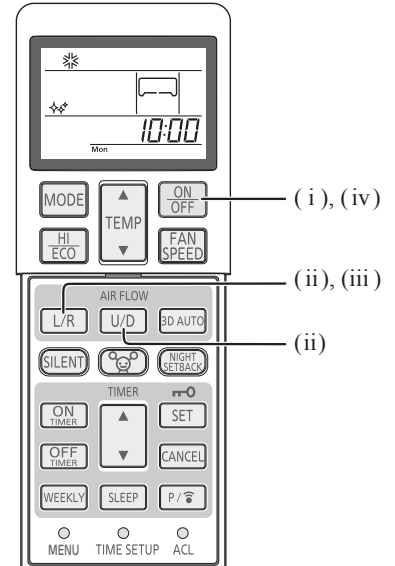

(iv) Press the ON/OFF button.

The air-conditioner's installation location is set.

Press within 60 seconds of setting the installation location (while the installation location setting display illuminates).

(15) Display brightness adjustment

This function can be used when it is necessary to adjust the brightness of unit display.

| Brightness level | Run light | Timer light |
|------------------|-----------|-------------|
| LV2 | 100% | 100% |
| LV1 | 50% | 50% |
| LV0 | 0% | 0% |

Note(1) When the unit displays self diagnosis or service mode, brightness level is always LV2.

(16) Outline of dehumidifying (DRY) operation

(a) Purpose of DRY mode

The purpose is "Dehumidification", and not to control the humidity to the target condition. Indoor/outdoor unit control the operation condition to reduce the humidity, and also prevent over cooling.

(b) Outline of control

(i) Indoor unit fan speed and compressor are controlled by the area which is selected by the temperature difference.

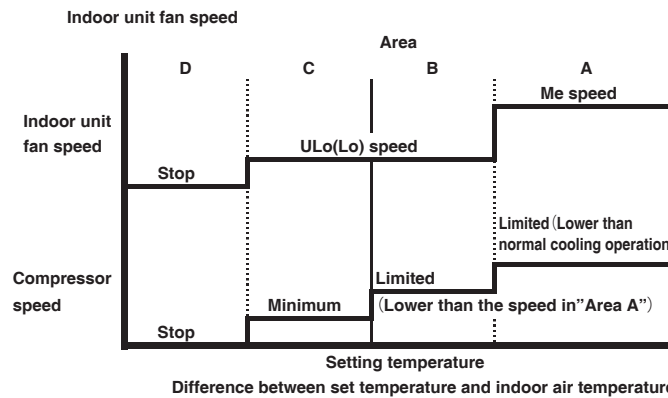

(ii) The indoor unit check the current area by every 5 minutes, and operate by the next checking.

(c) Other

When the outdoor air temperature and room temperature is low in cooling operation, indoor unit can not operate in cooling, and dehumidify. In this case, the units operate in heating to rise the indoor air temperature and after that start DRY operation.

(17) Outline of automatic operation

(a) Determination of operation mode

Operation mode is determined by indoor air temperature and outdoor air temperature as following.

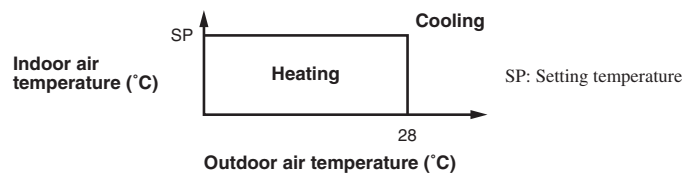

(b) Operation mode is changes when keep cooling and heating thermostat off 20 minutes and be satisfied following conditions. If the setting temperature is changed with the remote control, the operation mode is judged immediately.

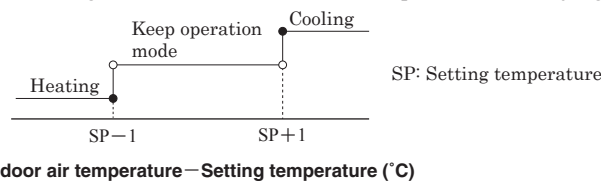

※It can not be changed to heating mode if outdoor air temperature is 28°C or higher.

(c) When the unit is started again within one hour after the stop of automatic operation or when the automatic operation is selected during heating, cooling or dehumidifying operation, the unit is operated in the previous operation mode.

(d) Setting temperature can be adjusted within the following range. There is the relationship as shown below between the signals of the wireless remote control and the setting temperature.

Unit : °C

| | | Signals of wireless remote control (Display) | | | | | | | | | | | | |
|---------------------|---------|--|----|----|----|----|----|----|----|----|----|----|----|----|
| | | 18 | 19 | 20 | 21 | 22 | 23 | 24 | 25 | 26 | 27 | 28 | 29 | 30 |
| Setting temperature | Cooling | 18 | 19 | 20 | 21 | 22 | 23 | 24 | 25 | 26 | 27 | 28 | 29 | 30 |
| | Heating | 20 | 21 | 22 | 23 | 24 | 25 | 26 | 27 | 28 | 29 | 30 | 31 | 32 |

(e) When the unit is operated automatically with the wired remote control, the cooling operation is controlled according to the display temperatures while the setting temperature is compensated by +2°C during heating.

(18) Protective control function

(a) Dew prevention control [Cooling]

Prevents dewing on the indoor unit.

(i) Operating conditions

When the following conditions have been satisfied for more than 30 minutes after starting operation

- 1) Detected value of humidity is 68% or higher.
- 2) The compressor is ON.

(ii) Contents of operation

- 1) Air capacity control

| Item | | Model | SRK20, 25ZS-W | SRK35ZS-W | SRK50ZS-W |
|------------|---------------|--|--|--|-----------|
| | | LO, ULO | 4th speed | 5th speed | 4th speed |
| Indoor fan | AUTO, HI, MED | Adaptable to compressor speed (Lower limit 4th speed) | Adaptable to compressor speed (Lower limit 5th speed) | Adaptable to compressor speed (Lower limit 4th speed) | |

- 2) When this control has continued for more than 30 minutes continuously, the following wind direction control is performed.
 - a) When the vertical wind direction is set at other than the vertical swing, the flaps change to the horizontal position.
 - b) When the horizontal wind direction is set at other than the horizontal swing, the louver changes to the vertical position.

(iii) Reset condition

When any of following is satisfied.

- 1) Detected value of humidity is less than 63%.
- 2) The compressor is OFF.

(b) Frost prevention control (During cooling or dehumidifying)

(i) Operating conditions

- 1) Indoor heat exchanger temperature (Th2) is lower than 5°C.
- 2) 5 minutes after reaching the compressor speed except 0 rps.

(ii) Detail of anti-frost operation

| Item | Indoor heat exchanger temperature | |
|--------------------------|-------------------------------------|--|
| | 5°C or lower | 2.5°C or lower |
| Compressor command speed | Reduced by 4 rps at each 20 seconds | 0 rps |
| Indoor fan | Depends on operation mode | Keep the fan speed before frost prevention control |
| Outdoor fan | Depends on compressor speed | Depends on stop mode |
| 4-way valve | OFF | |

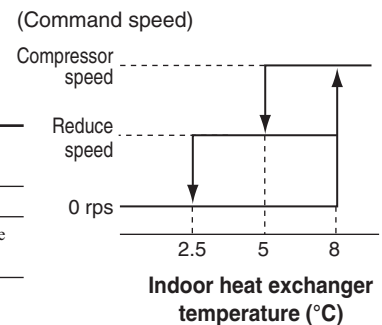

- Notes
- (1) When the indoor heat exchanger temperature is in the range of 2.5–5°C, the speed is reduced by 4 rps at each 20 seconds.
 - (2) When the temperature is lower than 2.5°C, the compressor is stopped.
 - (3) When the indoor heat exchanger temperature is in the range of 5–8°C, the compressor speed is been maintained.

(iii) Reset conditions

When either of the following condition is satisfied.

- 1) The indoor heat exchanger temperature (Th2) is 8°C or higher.
- 2) The compressor command speed is 0 rps.

(c) Indoor fan motor protection

When the air-conditioner is operating and the indoor fan motor is turned ON, if the indoor fan motor has operated at 300 min⁻¹ or under for more than 30 seconds, the unit enters first in the stop mode and then stops the entire system.

1.1.3 SRK-ZR series

(1) Operation control function by wireless remote control

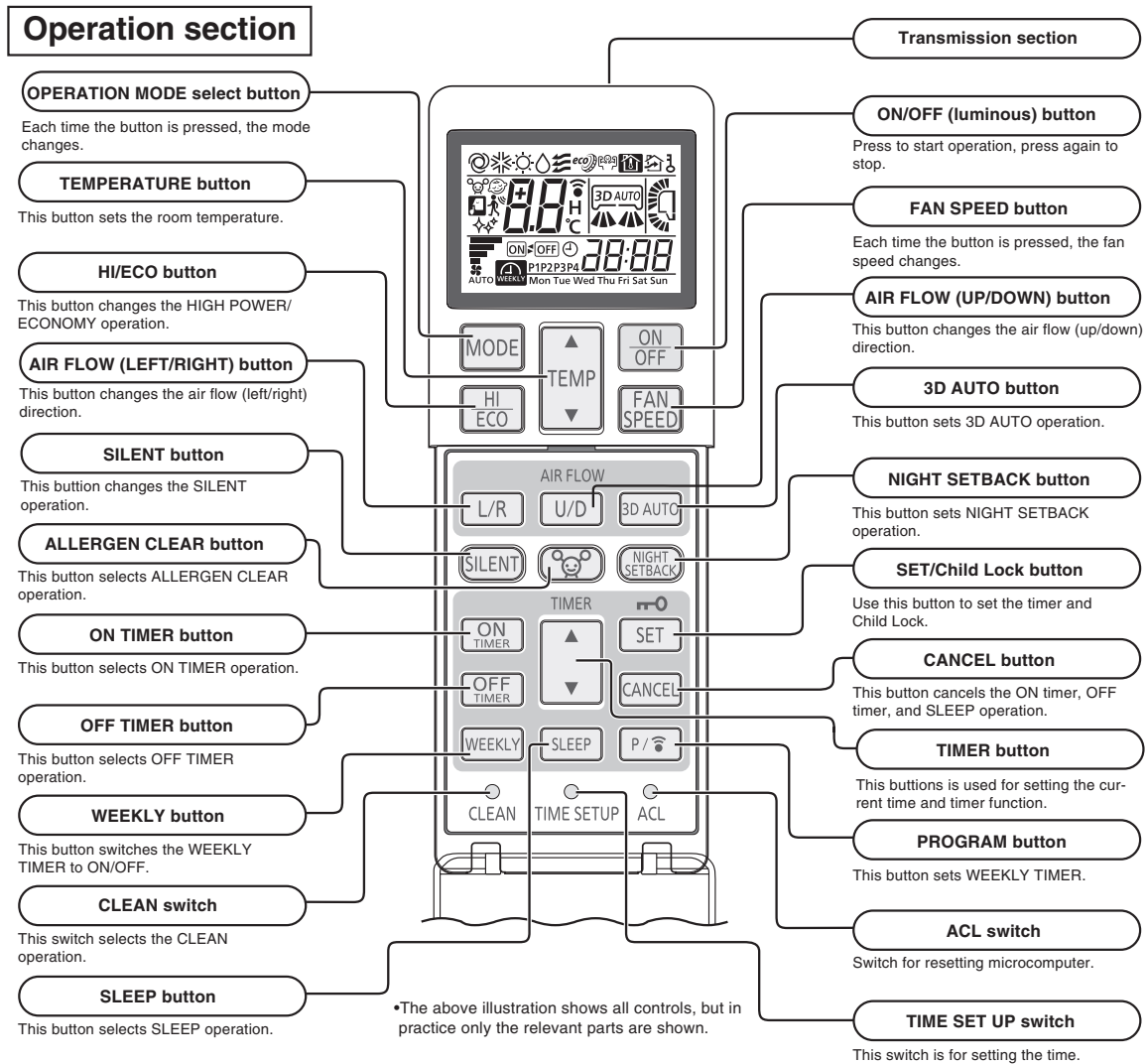

Unit display section

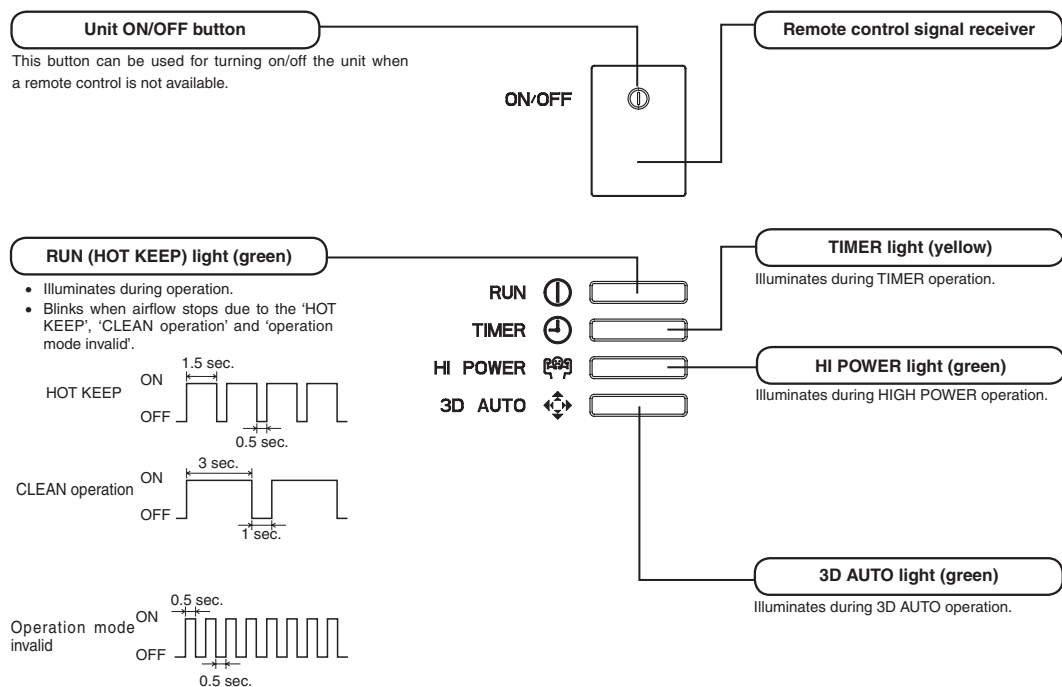

(2) Unit ON/OFF button

When the wireless remote control batteries become weak, or if the wireless remote control is lost or malfunctioning, this button may be used to turn the unit on and off.

(a) Operation

Push the button once to place the unit in the automatic mode. Push it once more to turn the unit off.

(b) Details of operation

The unit will go into the automatic mode in which it automatically determines, from indoor temperature (as detected by sensor), whether to go into COOL, DRY or HEAT modes.

| Function | Indoor temperature setting | Fan speed | Flap/Louver | Timer Switch |
|----------------|----------------------------|-----------|-------------|--------------|
| Operation mode | | | | |
| COOL | About 24°C | Auto | Auto | Continuous |
| DRY | | | | |
| HEAT | | | | |

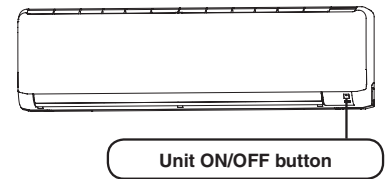

(3) Auto restart function

(a) Auto restart function records the operational status of the air-conditioner immediately prior to be switched off by a power cut, and then automatically resumes operations after the power has been restored.

(b) The following settings will be cancelled:

- (i) Timer settings
- (ii) HIGH POWER operations

- Notes
- (1) Auto restart function is set at on when the air-conditioner is shipped from the factory. Consult with your dealer if this function needs to be switched off.
 - (2) When power failure occurs, the timer setting is cancelled. Once power is resumed, reset the timer.
 - (3) If the jumper wire (JA1) "AUTO RESTART" is cut, auto restart is disabled. (See the diagram at right)

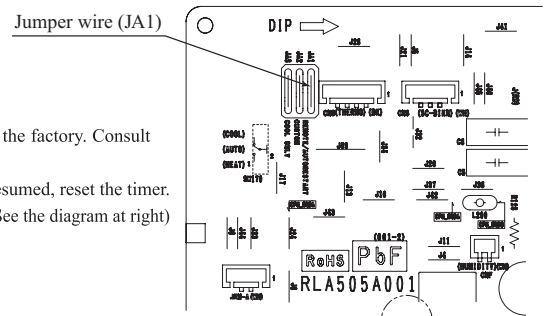

(4) Installing two air-conditioners in the same room

When two air-conditioners are installed in the room, use setting when the two air-conditioners are not operated with one wireless remote control. Set the wireless remote control and indoor unit.

(a) Setting the wireless remote control

- (i) Pull out the cover and take out batteries.
- (ii) Disconnect the switching line next to the battery with wire cutters.
- (iii) Insert batteries, Close the cover.

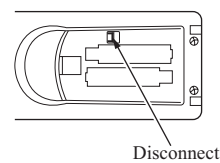

(b) Setting an indoor unit

- (i) Turn off the power source, and turn it on after 1 minute.
- (ii) Point the wireless remote control that was set according to the procedure described on the left side at the indoor unit and send a signal by pressing the ACL switch on the wireless remote control.
Since the signal is sent in about 6 seconds after the ACL switch is pressed, point the wireless remote control at the indoor unit for some time.
- (iii) Check that the reception buzzer sound "peep" is emitted from the indoor unit. At completion of the setting, the indoor unit emits a buzzer sound "peep". (If no reception tone is emitted, start the setting from the beginning again.)

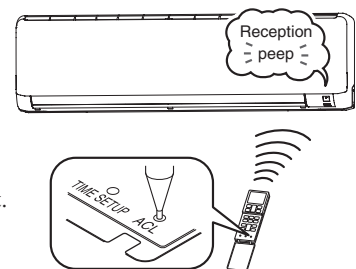

(5) Selection of the annual cooling function

- (a) The annual cooling control is valid from factory default setting. It is possible to disable by cutting jumper wire (JA3), or changing the setting of DIP switch (SW2-4) on the interface kit (option) PCB if it is connected.

| Jumper wire (JA3) | Interface kit (SC-BIKN2-E) SW2-4 | Function |
|-------------------|----------------------------------|---------------------------------|
| Shorted | ON | Enabled factory default setting |
| Shorted | OFF | Disabled |
| Open | ON | Disabled |
| Open | OFF | Disabled |

Notes: (1) Default states of the jumper wire (JA3) and the interface kit at the shipping from factory – On the PCB, the DIP switch (SW2-4) is set to enable the annual cooling function.

(2) To cancel the annual cooling setting, consult your dealer.

(b) Content of control

- (i) If the outdoor air temperature sensor (TH2 (Tho-A)) detects below 5°C, the indoor fan speed is switched to 8th step. (It is not possible to change.)
- (ii) If the outdoor air temperature sensor (TH2 (Tho-A)) detects higher than 7°C, the indoor fan speed is changed to the normal control speed.

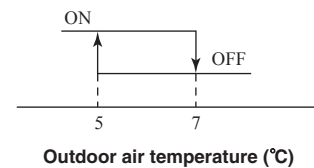
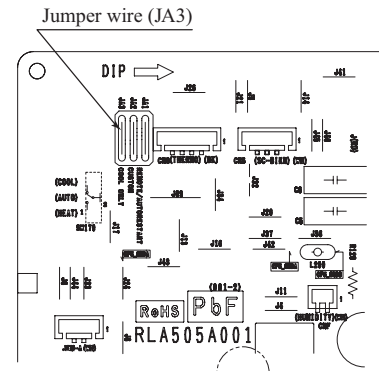
**(6) High power operation**

Pressing the HI/ECO button intensifies the operating power and initiates powerful cooling or heating operation for 15 minutes continuously. The wireless remote control displays HIGH POWER mark and the FAN SPEED display disappears.

- (a) During the HIGH POWER operation, the room temperature is not controlled. When it causes an excessive cooling or heating, press the HI/ECO button again to cancel the HIGH POWER operation.
- (b) HIGH POWER operation is not available during dehumidifying and the program timer operations.
- (c) When HIGH POWER operation is set after setting ON TIMER operation, HIGH POWER operation will start from the set time.
- (d) When the following operation are set, HIGH POWER operation will be cancelled.
 - ① When the HI/ECO button is pressed again. (The operation mode will be changed to the ECONOMY operation.)
 - ② When the operation mode is changed.
 - ③ When it has been 15 minutes since HIGH POWER operation has started.
 - ④ When the 3D AUTO button is pressed.
 - ⑤ When the SILENT button is pressed.
 - ⑥ When the NIGHT SETBACK button is pressed.
- (e) Not operable while the air-conditioner is OFF.
- (f) After HIGH POWER operation, the sound of refrigerant flowing may be heard.

(7) Economy operation

Pressing the HI/ECO button initiate a soft operation with the power suppressed in order to avoid an excessive cooling or heating.

The unit operates 1.5°C higher than the setting temperature during cooling or 2.5°C lower than that during heating. The wireless remote control displays ECONO mark and the FAN SPEED display disappears.

- (a) It will go into ECONOMY operation at the next time the air-conditioner runs in the following cases.
 - ① When the air-conditioner is stopped by ON/OFF button during ECONOMY operation.
 - ② When the air-conditioner is stopped in SLEEP or OFF TIMER operation during ECONOMY operation.
 - ③ When the operation is retrieved from SELF CLEAN or ALLERGEN CLEAR operation.
- (b) When the following operation are set, ECONOMY operation will be cancelled.
 - ① When the HI/ECO button is pressed again.
 - ② When the operation mode is changed from DRY to FAN.
 - ③ When the NIGHT SETBACK button is pressed.
- (c) Not operable while the air-conditioner is OFF.

(d) The setting temperature is adjusted according to the following table.

(Unit : deg°C)

| Item | Mode | Cooling | Heating |
|------------------------|------|--------------|---------------|
| Temperature adjustment | ① | +0.5 | -1.0 |
| | ② | +1.0 | -2.0 |
| | ③ | 1.0+Figure A | -2.0+Figure B |

- ① at the start of operation.
- ② one hour after the start of operation.
- ③ two hours after the start of operation.

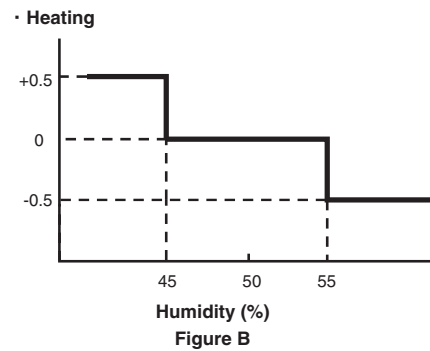
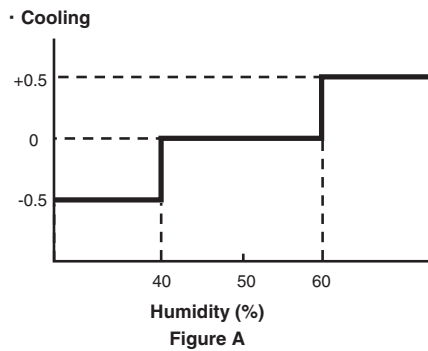

(8) Air flow direction adjustment

Control the flap and louver by AIR FLOW U/D (UP/DOWN) and L/R (LEFT/RIGHT) button on the wireless remote control.

(a) Flap

Each time when you press the AIR FLOW U/D (UP/DOWN) button the mode changes as follows.

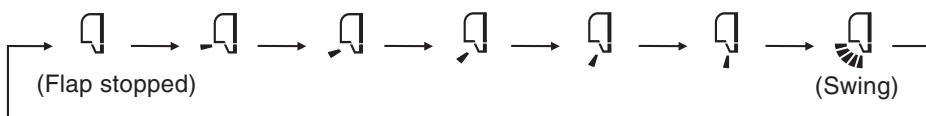

• Angle of Flap from Horizontal

| Remote control display | | | | | |
|------------------------|-------------|-------------|-------------|-------------|-------------|
| COOL , DRY, FAN | Approx. 5° | Approx. 20° | Approx. 35° | Approx. 50° | Approx. 70° |
| HEAT | Approx. 20° | Approx. 35° | Approx. 45° | Approx. 60° | Approx. 70° |

(b) Louver

Each time when you press the AIR FLOW L/R (LEFT/RIGHT) button the mode changes as follows.

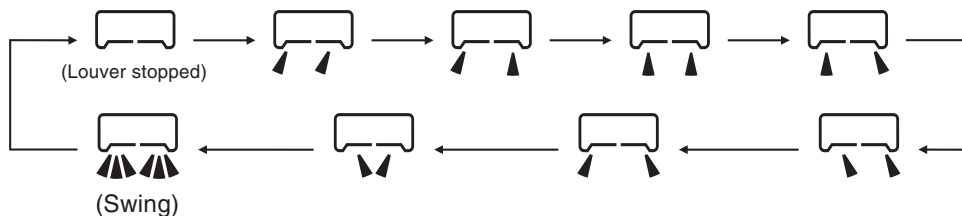

• Angle of Louver

| Remote control display | | | | | |
|------------------------|------------------|------------------|-------------------|-------------------|-------------------|
| Center installation | Left approx. 50° | Left approx. 20° | Center | Right approx. 20° | Right approx. 50° |
| Right end installation | Left approx. 50° | Left approx. 45° | Left approx. 30° | Center | Right approx. 20° |
| Left end installation | Left approx. 20° | Center | Right approx. 30° | Right approx. 45° | Right approx. 50° |

(c) Swing

(i) Swing flap

Flap moves in upward and downward directions continuously.

◆ In HEAT operation

◆ In COOL, DRY, FAN operation

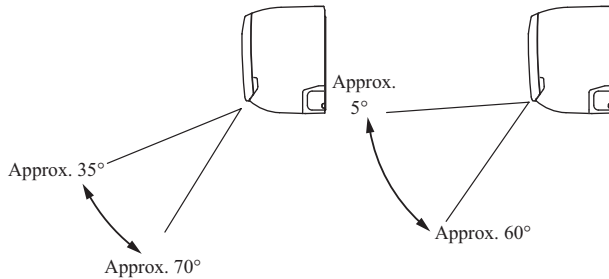

(ii) Swing louver

Louver moves in left and right directions continuously.



(d) Memory ap (Flap or Louver stopped)

When you press the AIR FLOW (UP/DOWN or LEFT/RIGHT) button once while the flap or louver is operating, it stops swinging at the position. Since this angle is memorized in the microcomputer, the flap or louver will automatically be set at this angle when the next operation is started.

(e) When not operating

The flap returns to the position of air flow directly below, when operation has stopped.

(9) 3D auto operation

Control the flap and louver by 3D AUTO button on the wireless remote control.

Air flow selection and air flow direction are automatically controlled, allowing the entire indoor to efficiently conditioned.

(a) During cooling and heating (Including auto cooling and heating)

(i) Air flow selection is determined according to indoor temperature and setting temperature.

| Operation mode | Air flow selection | | | | | |
|----------------|-----------------------------------|------------------------------------|----|-----|----|-----|
| | AUTO | | HI | MED | LO | ULO |
| Cooling | Indoor temp. – Setting temp. >5°C | Indoor temp. – Setting temp. ≤ 5°C | HI | MED | LO | ULO |
| | HIGH POWER | AUTO | | | | |
| Heating | Setting temp. – Indoor temp. >5°C | Setting temp. – Indoor temp. ≤ 5°C | HI | MED | LO | ULO |
| | HIGH POWER | AUTO | | | | |

(ii) Air flow direction is controlled according to the indoor temperature and setting temperature.

1) When 3D auto operation starts

| | Cooling | Heating |
|--------|---------------|----------------|
| Flap | Up/down swing | |
| Louver | Wide (Fixed) | Center (Fixed) |

2) When Indoor temp. – Setting temp. is ≤ 5°C during cooling and when Setting temp. – Indoor temp. is ≤ 5°C during heating, the system switches to the following air flow direction control. After the louver swings left and right symmetrically for 3 cycles, control is switched to the control in 3).

| | Cooling | Heating |
|--------|----------------------------|--------------------------------|
| Flap | Horizontal blowing (Fixed) | Slant forwardl blowing (Fixed) |
| Louver | Left/right swing | |

3) After the flap swings for 5 cycles, control is switched to the control in 4).

| | Cooling | Heating |
|--------|----------------|---------|
| Flap | Up/down swing | |
| Louver | Center (Fixed) | |

- 4) For 5 minutes, the following air flow direction control is carried out.

| | Cooling | Heating |
|---------------|----------------------------|--------------------------------|
| Flap | Horizontal blowing (Fixed) | Slant forwardl blowing (Fixed) |
| Louver | Wide (Fixed) | |

- 5) After 5 minutes have passed, the air flow direction is determined according to the indoor temperature and setting temperature.

| Operation mode | Air flow direction control | | |
|-----------------------|---|---|--|
| Cooling | Indoor temp. – Setting temp. $\leq 2^{\circ}\text{C}$ | $2^{\circ}\text{C} < \text{Indoor temp.} - \text{Setting temp.} \leq 5^{\circ}\text{C}$ | Indoor temp. – Setting temp. $> 5^{\circ}\text{C}$ |
| | The control in 4) continues. | Control returns to the control in 2). | Control returns to the control in 1). |
| Heating | Setting temp. – Indoor temp. $\leq 2^{\circ}\text{C}$ | $2^{\circ}\text{C} < \text{Setting temp.} - \text{Indoor temp.} \leq 5^{\circ}\text{C}$ | Setting temp. – Indoor temp. $> 5^{\circ}\text{C}$ |
| | The control in 4) continues. | Control returns to the control in 2). | Control returns to the control in 1). |

- (b) During dehumidifying operation (including auto dehumidifying operation)

| | |
|---------------|----------------------------|
| Flap | Horizontal blowing (Fixed) |
| Louver | Wide (Fixed) |

(10) Timer operation

(a) Comfortable timer setting (ON timer)

The unit starts the operation 5 to 60 minutes earlier so that the room can approach optimum temperature at ON timer.

(b) Sleep timer operation

Pressing the SLEEP button causes the temperature to be controlled with respect to the set temperature.

(c) OFF timer operation

The Off timer can be set at a specific time (in 10-minute units) within a 24-hour period.

(d) Weekly timer operation

Up to 4 programs with timer operation (ON timer / OFF timer) are available for each day of the week.

Note (1) Timer operation from wireless remote control becomes invalid when you connect the interface kit (such as SC-BIKN2-E).

(11) Silent operation

When the silent operation is set, the unit operates by dropping the outdoor fan speed and the compressor speed.

| | SCM71 | | SCM80 | |
|--|----------------|----------------|----------------|----------------|
| | Cooling | Heating | Cooling | Heating |
| Outdoor fan speed (Upper limit) | 4th speed | 4th speed | 4th speed | 4th speed |
| Compressor speed (Upper limit) | 40 rps | 55 rps | 45 rps | 60 rps |

(12) Night setback operation

As “Night setback” signal is received from the wireless remote control, the heating operation starts with the setting temperature at 10°C .

(13) Air flow range setting

When the indoor unit is installed at the end of a room, control the air flow direction so that it is not toward the side walls. If you set the wireless remote control installation position, keep it so that the air flow is within the range shown in the following figure.

(a) Setting

- (i) If the air-conditioning unit is running, press the ON/OFF button to stop.**

The installation location setting cannot be made while the unit is running.

- (ii) Press the AIR FLOW U/D (UP/DOWN) button and the AIR FLOW L/R (LEFT/RIGHT) button together for 5 seconds or more.**

The installation location display illuminates.

- (iii) Setting the air-conditioning installation location.**

Press the AIR FLOW L/R (LEFT/RIGHT) button and adjust to the desired location.

Each time the AIR FLOW L/R (LEFT/RIGHT) button is pressed, the indicator is switched in the order of:

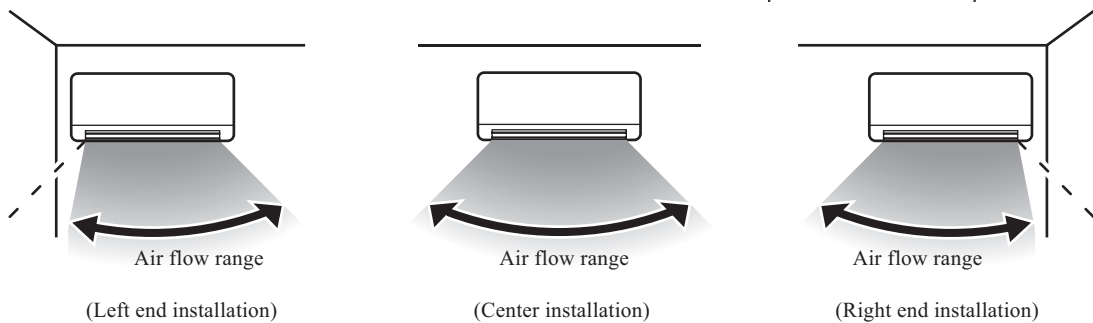
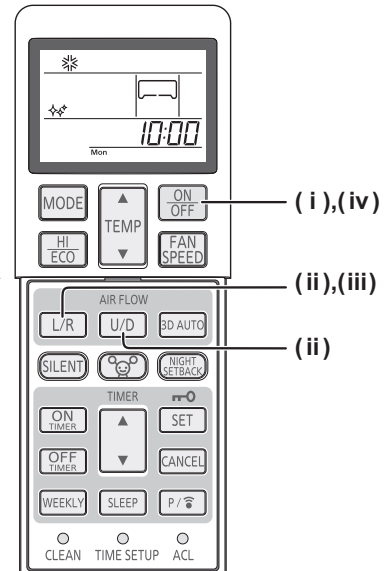

- (iv) Press the ON/OFF button.**

The air-conditioner's installation location is set.

Press within 60 seconds of setting the installation location (while the installation location setting display illuminates).

(14) Outline of dehumidifying (DRY) operation

(a) Purpose of DRY mode

The purpose is "Dehumidification", and not to control the humidity to the target condition. Indoor/outdoor unit control the operation condition to reduce the humidity, and also prevent over cooling.

(b) Outline of control

(i) Indoor unit fan speed and compressor are controlled by the area which is selected by the temperature difference.

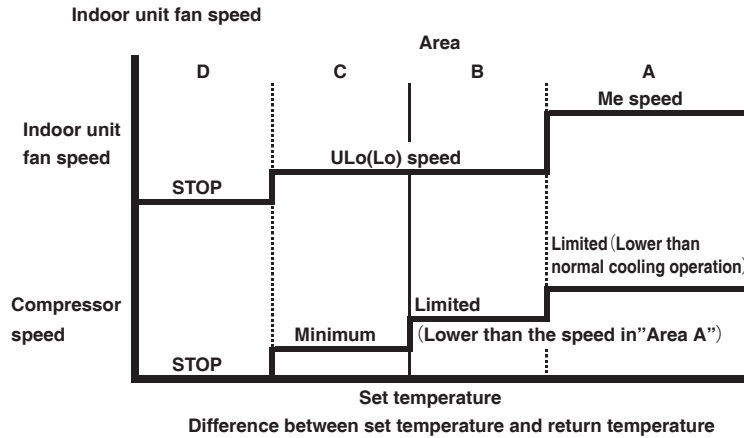

(ii) The indoor unit check the current area by every 5 minutes, and operate by the next checking.

(c) Other

When the outside temperature and room temperature is low for cooling operation, indoor unit can not operate in cooling, and dehumidifying. In this case, the units operate in heating to rise the room temperature and after that start dehumidifying operation.

(15) Outline of automatic operation

(a) Determination of operation mode

Operation mode is determined by indoor air temperature and outdoor air temperature as following.

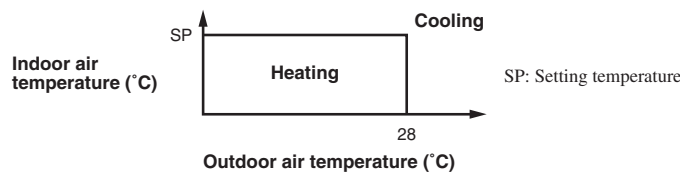

(b) Operation mode is changes when keep cooling and heating thermostat off 20 minutes and be satisfied with following conditions.

If the setting temperature is changed with the remote control, the operation mode is judged immediately.

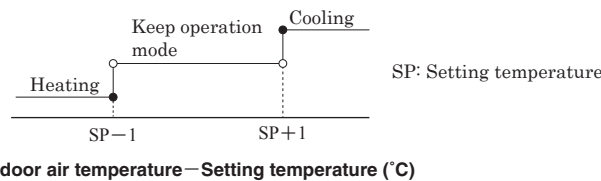

※It can not be changed to heating mode if outdoor air temperature is 28°C or higher.

(c) When the unit is started again within one hour after the stop of automatic operation or when the automatic operation is selected during heating, cooling or DRY mode, the unit is operated in the previous operation mode.

(d) Setting temperature can be adjusted within the following range. There is the relationship as shown below between the signals of the wireless remote control and the setting temperature.

| | | Signals of wireless remote control (Display) | | | | | | | | | | | | |
|---------------------|---------|--|----|----|----|----|----|----|----|----|----|----|----|----|
| | | -6 | -5 | -4 | -3 | -2 | -1 | ±0 | +1 | +2 | +3 | +4 | +5 | +6 |
| Setting temperature | Cooling | 18 | 19 | 20 | 21 | 22 | 23 | 24 | 25 | 26 | 27 | 28 | 29 | 30 |
| | Heating | 18 | 19 | 20 | 21 | 22 | 23 | 24 | 25 | 26 | 27 | 28 | 29 | 30 |

Unit : °C

(16) Protective control function

(a) Dew prevention control [Cooling]: Prevents dewing on the indoor unit.

(i) Operating conditions

When the following conditions have been satisfied for more than 30 minutes after starting operation.

- 1) The compressor is ON.
- 2) Detected value of humidity is 68% or higher.

(ii) Contents of operation

- 1) Air capacity control

| Model | | SRK71ZR-W |
|------------|------------------------|-------------------------------|
| Item | | |
| Indoor fan | AUTO, HI, MED, LO, ULO | Adaptable to compressor speed |

- 2) When this control has continued for more than 30 minutes continuously, the following wind direction control is performed.
 - a) When the vertical wind direction is set at other than the vertical swing, the flaps change to the horizontal position.
 - b) When the horizontal wind direction is set at other than the horizontal swing, the louver changes to the vertical position.

(iii) Reset conditions

When any of followings is satisfied.

- 1) Detected value of humidity is less than 63%.
- 2) The compressor is OFF.

(b) Frost prevention control (During cooling or dehumidifying)

(i) Operating conditions

- 1) Indoor heat exchanger temperature (Th2) is lower than 5°C.
- 2) 5 minutes after reaching the compressor command speed except 0 rps.

(ii) Detail of anti-frost operation

| Indoor heat exchanger temperature | 5°C or lower | 2.5°C or lower |
|-----------------------------------|-------------------------------------|---|
| Item | | |
| Compressor command speed | Reduced by 4 rps at each 20 seconds | 0 rps |
| Indoor fan | Depends on operation mode | Protects the fan tap just before frost prevention control |
| Outdoor fan | Depends on command speed | Depends on stop mode |
| 4-way valve | OFF | |

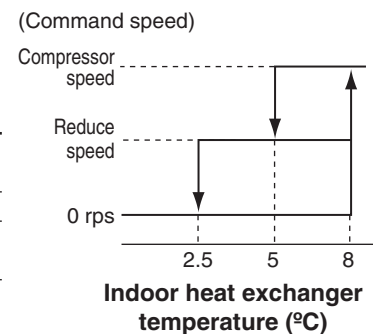

- Notes
- (1) When the indoor heat exchanger temperature is in the range of 2.5-5°C, the speed is reduced by 4 rps at each 20 seconds.
 - (2) When the temperature is lower than 2.5°C, the compressor is stopped.
 - (3) When the indoor heat exchanger temperature is in the range of 5-8°C, the compressor command speed is been maintained.

(iii) Reset conditions

When either of the following condition is satisfied.

- 1) The indoor heat exchanger temperature (Th2) is 8°C or higher.
- 2) The compressor command speed is 0 rps.

(c) Indoor fan motor protection

When the air-conditioner is operating and the indoor fan motor is turned ON, if the indoor fan motor has operated at 300 min⁻¹ or under for more than 30 seconds, the unit enters first in the stop mode and then stops the entire system.

1.1.4 SRR series

(1) Operation control function by wireless remote control

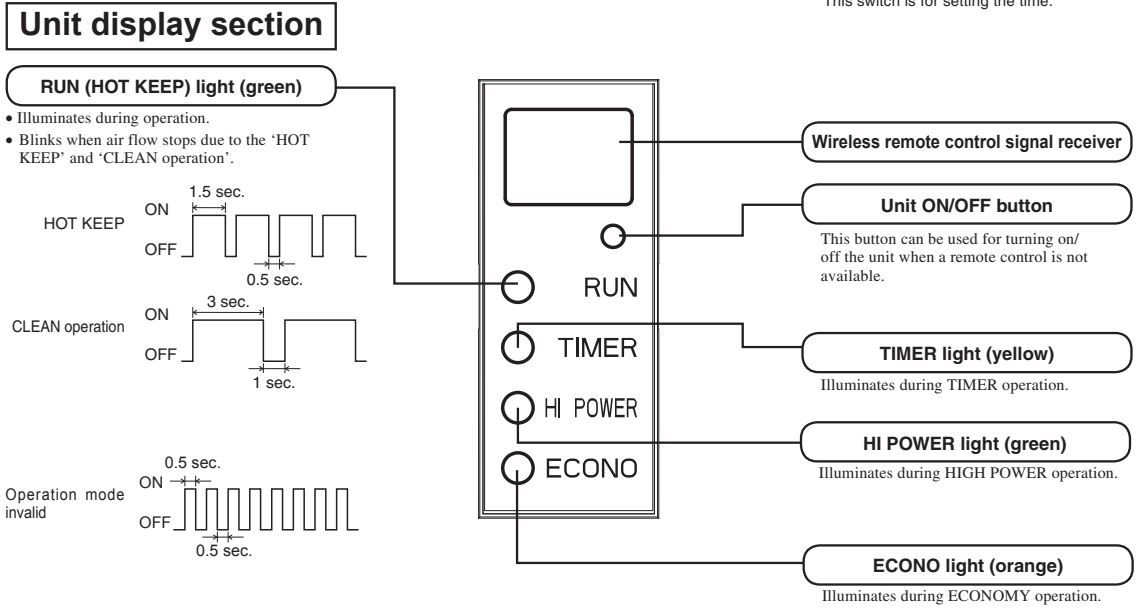
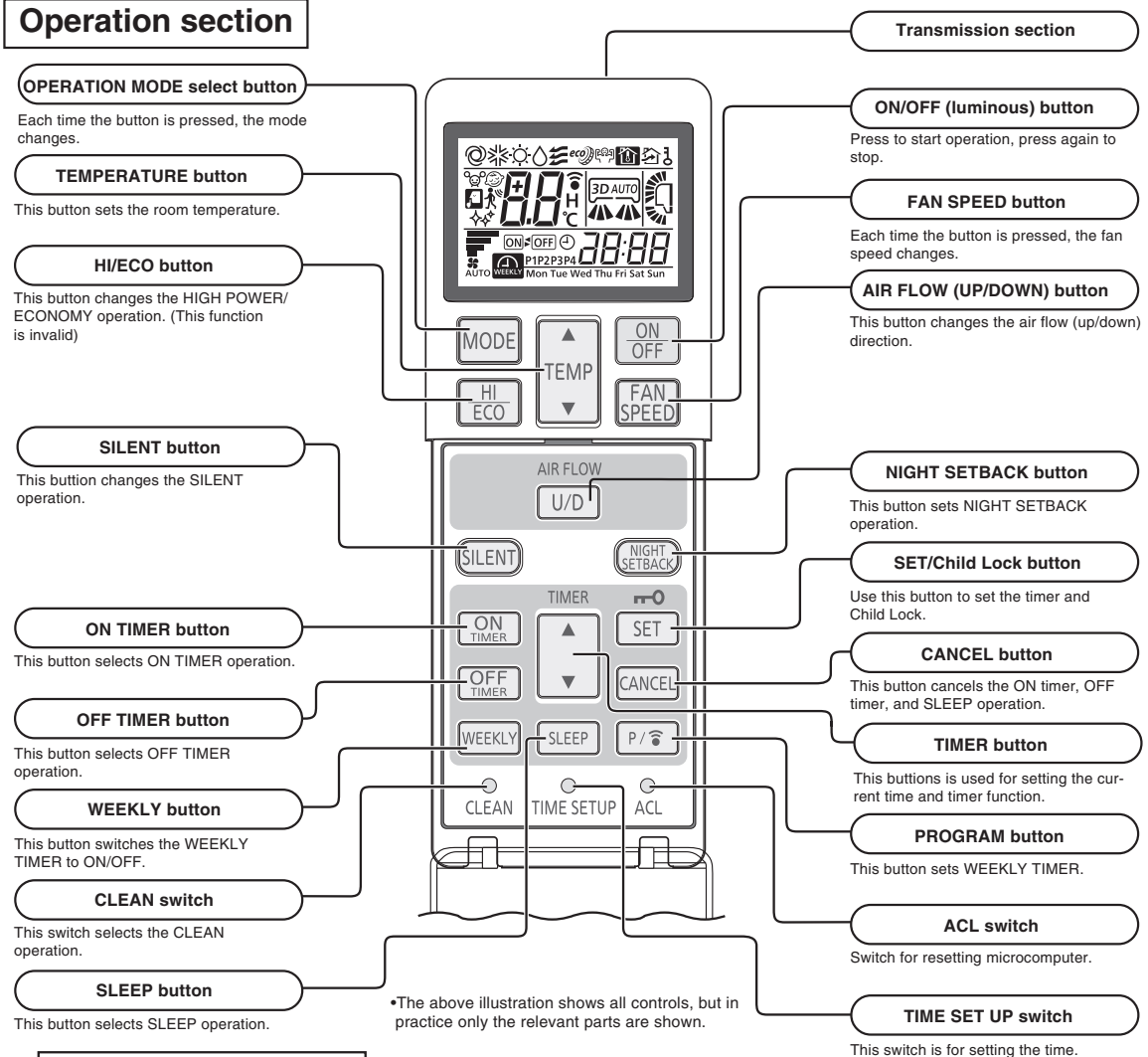

(2) Unit ON/OFF button

When the wireless remote control batteries become weak, or if the wireless remote control is lost or malfunctioning, this button may be used to turn the unit on and off.

(a) Operation

Push the button once to place the unit in the automatic mode. Push it once more to turn the unit off.

(b) Details of operation

The unit will go into the automatic mode in which it automatically determines, from indoor temperature (as detected by sensor), whether to go into COOL, DRY or HEAT modes.

| Function Operation mode | Indoor temperature setting | Fan speed | Flap/Louver | Timer switch |
|----------------------------|-------------------------------|-----------|-------------|-----------------|
| COOL | About 24°C | Auto | Auto | Continuous |
| DRY | About 25°C | | | |
| HEAT | About 26°C | | | |

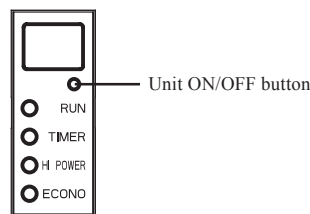

(3) Auto restart function

(a) Auto restart function records the operational status of the air-conditioner immediately prior to be switched off by a power cut, and then automatically resumes operations after the power has been restored.

(b) The following settings will be cancelled:

- (i) Timer settings
- (ii) HIGH POWER operations

Notes (1) Auto restart function is set at on when the air-conditioner is shipped from the factory. Consult with your dealer if this function needs to be switched off.
 (2) When power failure occurs, the timer setting is cancelled. Once power is resumed, reset the timer.
 (3) If the jumper wire (J170 or JA1) "AUTO RESTART" is cut, auto restart is disabled.

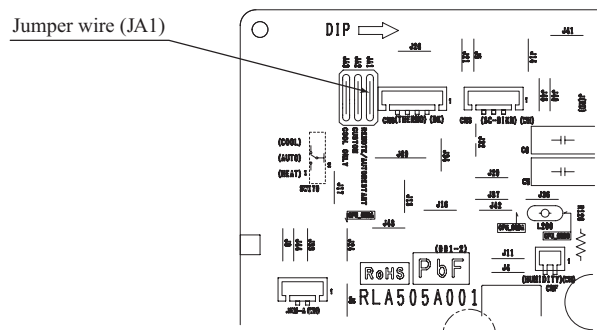

(4) Installing two air-conditioners in the same room

When two air-conditioners are installed in the room, use setting when the two air-conditioners are not operated with one wireless remote control. Set the wireless remote control and indoor unit.

(a) Setting the wireless remote control

- (i) Pull out the cover and take out batteries.
- (ii) Disconnect the switching line next to the battery with wire cutters.
- (iii) Insert batteries, Close the cover.

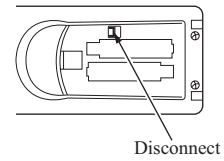

(b) Setting an indoor unit

- (i) Turn off the power source, and turn it on after 1 minute.
- (ii) Point the wireless remote control that was set according to the procedure described on the underside at the indoor unit and send a signal by pressing the ACL switch on the wireless remote control. Since the signal is sent in about 6 seconds after the ACL switch is pressed, point the wireless remote control at the indoor unit for some time.
- (iii) Check that the reception buzzer sound "Peep" is emitted from the indoor unit. At completion of the setting, the indoor unit emits a buzzer sound "Peep".(If no reception tone is emitted, start the setting from the beginning again.)

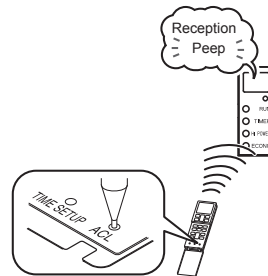

(5) Selection of the annual cooling function

- (a) The annual cooling function can be enabled or disabled by means of the jumper wire (J172 or JA3) on the indoor unit PCB or the DIP switch (SW2-4) on the interface kit (option) PCB.

| Jumper wire (J172 or JA3) | Interface kit (SC-BIKN2-E) SW2-4 | Function |
|---------------------------|----------------------------------|----------|
| Shorted | ON | Enabled |
| Shorted | OFF | Disabled |
| Open | ON | Disabled |
| Open | OFF | Disabled |

Notes (1) Default states of the jumper wire (J172 or JA3) and the interface kit at the shipping from factory – On the PCB, the DIP switch (SW2-4) is set to enable the annual cooling function.
 (2) To cancel the annual cooling setting, consult your dealer.

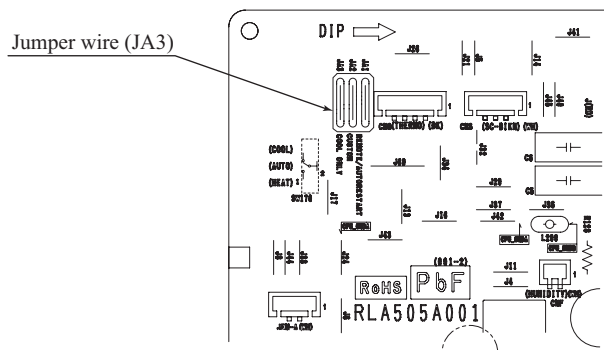

(b) Content of control

- (i) If the outdoor air temperature sensor (TH2 (Tho-A)) detects below 5°C, the indoor unit speed is switched to 9th step. (It is not possible to change.)
- (ii) If the outdoor air temperature sensor (TH2 (Tho-A)) detects higher than A°C, the indoor unit speed is changed to the normal control speed.

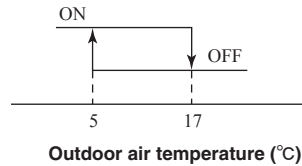

(6) High power operation

Pressing the HI POWER/ECONO button intensifies the operating power and initiates powerful cooling and heating operation for 15 minutes continuously. The wireless remote control displays and the FAN SPEED display disappears.

- (a) During the HIGH POWER operation, the room temperature is not controlled. When it causes an excessive cooling and heating, press the HI POWER/ECONO button again to cancel the HIGH POWER operation.
- (b) HIGH POWER operation is not available during dehumidifying and the program timer operations.
- (c) When HIGH POWER operation is set after ON TIMER operation, HIGH POWER operation will start from the set time.
- (d) When the following operation are set, HIGH POWER operation will be cancelled.
 - ① When the HI POWER/ECONO button is pressed again.
 - ② When the operation mode is changed.
 - ③ When it has been 15 minutes since HIGH POWER operation has started.
 - ④ When the SILENT button is pressed.
 - ⑤ When the NIGHT SETBACK button is pressed.
- (e) Not operable while the air-conditioner is OFF.
- (f) After HIGH POWER operation, the sound of refrigerant flowing may be heard.

(7) Economy operation

Pressing the HI POWER/ECONO button initiate a soft operation with the power suppressed in order to avoid an excessive cooling or heating. The unit operate 1.5°C higher than the setting temperature during cooling or 2.5°C lower than that during heating. The wireless remote control displays ECONO mark and the FAN SPEED display disappears.

- (a) It will go into ECONOMY operation at the next time the air-conditioner runs in the following cases.
 - ① When the air-conditioner is stopped by ON/OFF button during ECONOMY operation.
 - ② When the air-conditioner is stopped in SLEEP or OFF TIMER operation during ECONOMY operation.
 - ③ When the operation is retrieved from CLEAN or ALLERGEN CLEAR operation.
- (b) When the following operation are set, ECONOMY operation will be cancelled.
 - ① When the HI POWER/ECONO button is pressed again.
 - ② When the operation mode is changed DRY to FAN.
- (c) Not operable while the air-conditioner is OFF.
- (d) The setting temperature is adjusted according to the following table.

| Item \ Mode | Cooling | Heating |
|------------------------|---------|---------|
| Temperature adjustment | ① +0.5 | ① -1.0 |
| | ② +1.0 | ② -2.0 |
| | ③ +1.5 | ③ -2.5 |

- ① at the start of operation.
- ② one hour after the start of operation.
- ③ two hours after the start of operation.

(8) Timer operation

(a) Comfortable timer setting (ON timer)

If the timer is set at ON when the operation select switch is set at the cooling or heating, or the cooling or heating in auto mode operation is selected, the comfortable timer starts and determines the starting time of next operation based on the initial value of 15 minutes and the relationship between the room temperature at the setting time and the setting temperature.

(b) Sleep timer operation

Pressing the SLEEP button causes the temperature to be controlled with respect to the set temperature.

(c) OFF timer operation

The OFF timer can be set at a specific time (in 10-minute units) within a 24-hour period.

(d) Weekly timer operation

Timer operation (ON timer, OFF timer) can be set up to 4 times a day for each weekday.

Note (1) Timer operation from wireless remote control becomes invalid when you connect the interface kit (such as SC-BIKN2-E).

(9) Night setback operation

As “Night setback” signal is received from the wireless remote control, the heating operation starts with the setting temperature at 10°C.

(10) Determining the operating mode

The cooling and heating operating modes are the wireless remote control mode that have been previously determined.

If a mode differing from these is selected after this, the selected mode will appear in the display of the wireless remote control, but only the fan will operate.

| Example | First operation | | | Second operation | | | Notes |
|---------|-----------------|------------------------|-----------|------------------|------------------------|--------------------|---|
| | Selected mode | Remote control display | Operation | Selected mode | Remote control display | Operation | |
| 1 | Cooling | COOL | COOL | Heating | HEAT | FAN ⁽¹⁾ | • Different mode is only fan operation. |
| 2 | Heating | HEAT | HEAT | Cooling | COOL | FAN | |

Note (1) If the display shows heating and the operation is fan, Hot keep will operate.

Example of operating pattern

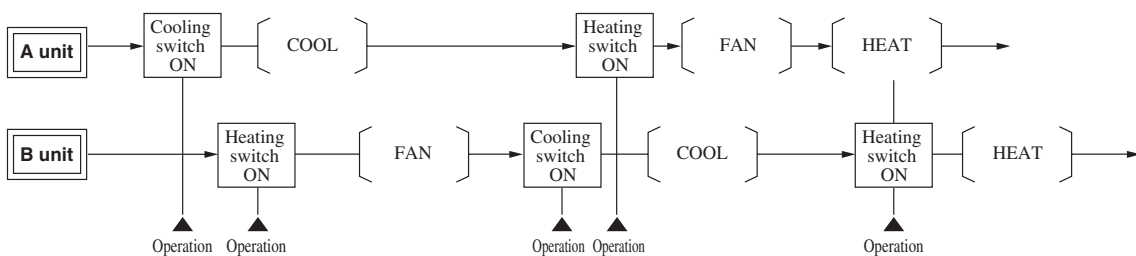

Note (1) (○) indicates correct operation.

(11) Drain pump abnormalities detection

- (a) Drain pump motor (DM) is operated during the cooling or dehumidifying mode operations and simultaneously with the compressor ON. The DM continues to operate for 5 minutes after the operation stop, anomalous stop, thermostat stop or when it was switched from the COOL and DRY operations to the fan or HEAT operation.

| | Indoor unit operation mode | | | | |
|----------------|----------------------------|------|-----|--------------------|------|
| | Stop ⁽¹⁾ | COOL | DRY | FAN ⁽²⁾ | HEAT |
| Compressor ON | Control A | | | | |
| Compressor OFF | | | | | |

Notes (1) Including the stop from the cooling, dehumidifying, fan and heating, and the anomalous stop
 (2) Including the “FAN” operation according to the mismatch of operation modes

(i) Control A

- 1) If the float switch detects any anomalous draining condition, the unit stops with the anomalous stop and the drain pump starts. After detecting the anomalous condition, the drain pump motor continues to be ON.
- 2) It keeps operating while the float switch is detecting the anomalous condition.

(ii) Control B

If the float switch detects any anomalous drain condition, the drain pump motor is turned ON for 5 minutes, and at 10 seconds after the drain pump motor OFF it checks the float switch. If it is normal, the unit is stopped under the normal mode or, if there is any anomalous condition, displayed by the flashing of display lights and the drain pump motor is turned ON. (The ON condition is maintained during the drain detection.)

(12) Outline of dehumidifying (DRY) operation

(a) Purpose of DRY mode

The purpose is "Dehumidifying", and not to control the humidity to the target condition.

Indoor/outdoor unit control the operation condition to reduce the humidity, and also prevent over cooling.

(b) Outline of control

(i) Indoor unit fan speed and compressor are controlled by the area which is selected by the temperature difference.

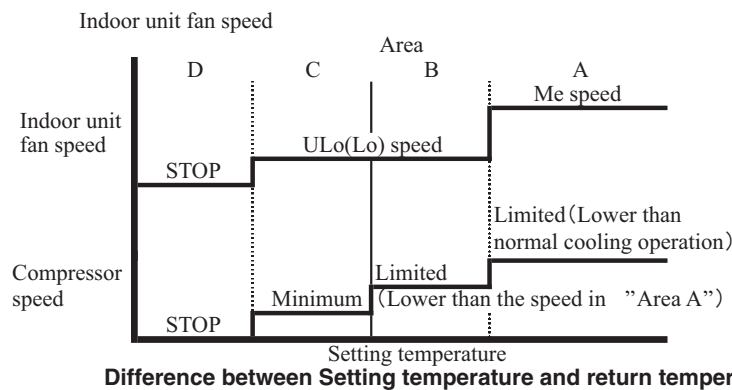

(ii) The indoor unit check the current area by every 5 minutes, and operate by the next checking.

(c) Other

When the outdoor air temperature and room temperature is low for cooling operation, indoor unit can not operate in cooling, and dehumidifying. In this case, the units operate in heating to rise the room temperature, and after that start dehumidifying operation.

(13) Outline of automatic operation

(a) Determination of operation mode

The unit checks the indoor air temperature and the outdoor air temperature, determines the operation mode, and then begins in the automatic operation.

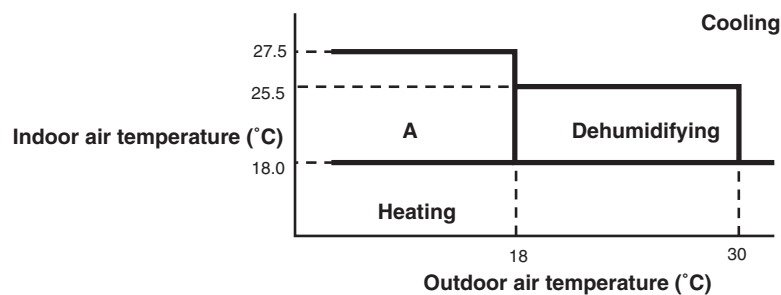

(b) The unit checks the temperature every hour after the start of operation and, if the result of check is not same as the previous operation mode, changes the operation mode.

- (i) If the setting temperature is changed with the wireless remote control, the operation mode is judged immediately.
- (ii) When both the indoor and the outdoor air temperatures are in the range "A", cooling or heating is switched depending on the difference between the setting temperature and the indoor air temperature.
- (iii) When the operation mode has been judged following the change of setting temperature with the wireless remote control, the hourly judgment of operation mode is cancelled.

- (c) When the unit is started again within one hour after the stop of automatic operation or when the automatic operation is selected during heating, cooling or dehumidifying operation, the unit is operated in the previous operation mode.
- (d) Setting temperature can be adjusted within the following range. There is the relationship as shown below between the signals of the wireless remote control and the setting temperature.

Unit : °C

| | | Signals of wireless remote control (Display) | | | | | | | | | | | | |
|---------------------|---------------|--|----|----|----|----|----|----|----|----|----|----|----|----|
| | | -6 | -5 | -4 | -3 | -2 | -1 | ±0 | +1 | +2 | +3 | +4 | +5 | +6 |
| Setting temperature | Cooling | 18 | 19 | 20 | 21 | 22 | 23 | 24 | 25 | 26 | 27 | 28 | 29 | 30 |
| | Dehumidifying | 19 | 20 | 21 | 22 | 23 | 24 | 25 | 26 | 27 | 28 | 29 | 30 | 31 |
| | Heating | 20 | 21 | 22 | 23 | 24 | 25 | 26 | 27 | 28 | 29 | 30 | 31 | 32 |

- (e) When the unit is operated automatically with the wired remote control connected, the cooling operation is controlled according to the display temperatures while the setting temperature is compensated by +1°C during dehumidifying or by +2°C during heating.

(14) Operation permission/prohibition control

The air-conditioner operation is controlled by releasing the jumper wire (J3) on the indoor unit PCB and inputting the external signal into the CnT.

Note (1) Please install the separately-sold interface kit (SC-BIKN2-E). Remove the jumper wire (J1 or J3) from the interface kit circuit board.

- (a) The operation mode is switched over between permission and prohibition by releasing the jumper wire (J3) on the indoor unit PCB.**

| When the jumper wire (J3) is short circuited | When the jumper wire (J3) is released |
|--|---|
| Normal operation is enable (when shipping) When CnT input is set to ON, the operation starts and if the input is set to OFF, the operation stops. For the CnT and remote control inputs, the input which is activated later has priority and can start and stop the operation. | Permission / Prohibition mode When CnT input is set to ON, the operation mode is changed to permission and if input is set to OFF the operation is prohibited. |

- (b) In the case of CnT input ON (Operation permission)**

- (i) The air-conditioner can be operated or stopped by the wired remote control signal.
(When the "CENTER" mode is set, the operation can be controlled only by the center input.)
- (ii) When the CnT input is changed from OFF to ON, the air-conditioner operation mode is changed depending on the status of the jumper wire (J1) on the indoor control board.

| When the jumper wire (J1) is short circuited | When the jumper wire (J1) is released |
|--|--|
| The signal (a) above starts the air-conditioner. (Shipping status) | When the CnT input is set to ON, the air-conditioner starts operation. After that, the operation of the air-conditioner depends on (a) above. (Local status) |

- (c) In the case of CnT input OFF (Operation prohibition)**

- (i) Air-conditioner is unable to control the operation/stop, ect. in accordance with signals from the wired remote control signal wire.
- (ii) Air-conditioner stops as it changes CnT input ON → OFF.

(15) External control (remote display) /control of input signal

- (a) External control (remote display) output**

Following output connectors (CnT) are provided on the printed circuit board of indoor unit.

Note (1) Please install the separately-sold interface kit (SC-BIKN2-E). The output connector (CnT) is located on the circuit board of the Interface kit.

- **Operation output:** Power to engage DC 12V relay (provided by the customer) is outputted during operation.
- **Heating output:** Power to engage DC 12V relay (provided by the customer) is outputted during the heating operation.
- **Compressor OPERATION output:** Power to engage DC 12V relay (provided by the customer) is outputted while the compressor is operating.
- **MALFUNCTION output:** When any error occurs, the power to engage DC 12V relay (provided by the customer) is outputted.

(b) Control of input signal

Control of input signal (switch input, timer input) connectors (CnT) are provided on the printed circuit board of indoor unit. However, when the operation of air-conditioner is under the “CENTER” mode, the wired remote control by CnT is invalid.

(i) Level input

If the factory settings (Jumper wire J1 EXTERNAL INPUT on the PCB of indoor unit) are set, or “LEVEL INPUT” is selected in the wired remote control’s indoor unit settings.

- 1) Input signal to CnT OFF → ON - - - - - Air-conditioner ON
- 2) Input signal to CnT ON → OFF - - - - - Air-conditioner OFF

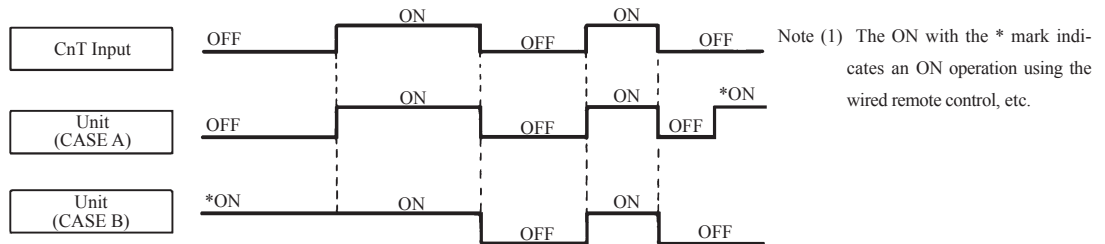

(ii) Pulse input

When Jumper wire J1 on the PCB of indoor unit is cut at the field or “PULSE INPUT” is selected in the wired remote control’s indoor unit settings.

Input signal to CnT becomes valid at OFF → ON only and the motion of air-conditioner [ON/OFF] is inverted.

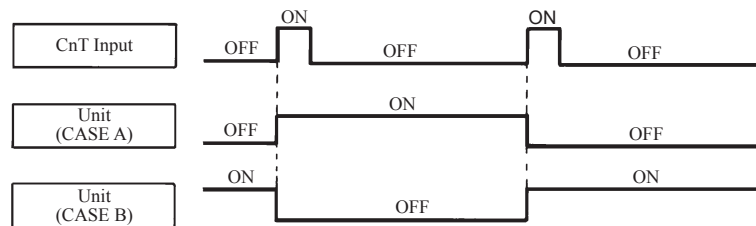

(16) Hot keep operation

If the hot keep operation is selected during the heating operation, the indoor fan is controlled based on the temperature of the indoor heat exchanger (Th2) to prevent blowing of cool wind.

However, if the fan speed setting is HI and room temperature is 19°C or higher, this control is not executed.

(17) Frost prevention control (During cooling or dehumidifying)

(a) Operating conditions

- (i) Indoor heat exchanger temperature (Th2) is lower than 2.5°C.
- (ii) 8 minutes after reaching the compressor command speed except 0 rps.

(b) Detail of anti-frost operation

| Operation mode | Protective control | Reset |
|----------------------|---------------------------|---------------------------|
| Compressor operation | Forced outage | Operation instruction |
| Indoor fan | Depends on operation mode | Depends on operation mode |

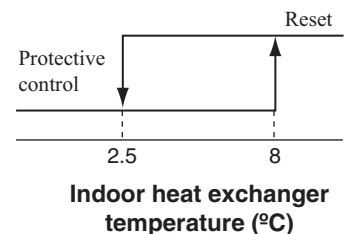

(c) Reset condition

The indoor heat exchanger temperature (Th2) is 8°C or higher.

(18) Indoor fan motor protection

When the air-conditioner is operating and the indoor fan motor is turned ON, if the indoor fan motor has operated at 300 min⁻¹ or under for more than 30 seconds, the unit enters first in the stop mode and then stops the entire system.

1.2 FDTC, FDUM and FDE series

1.2.1 Wired remote control (Option parts)

Model RC-EX3A

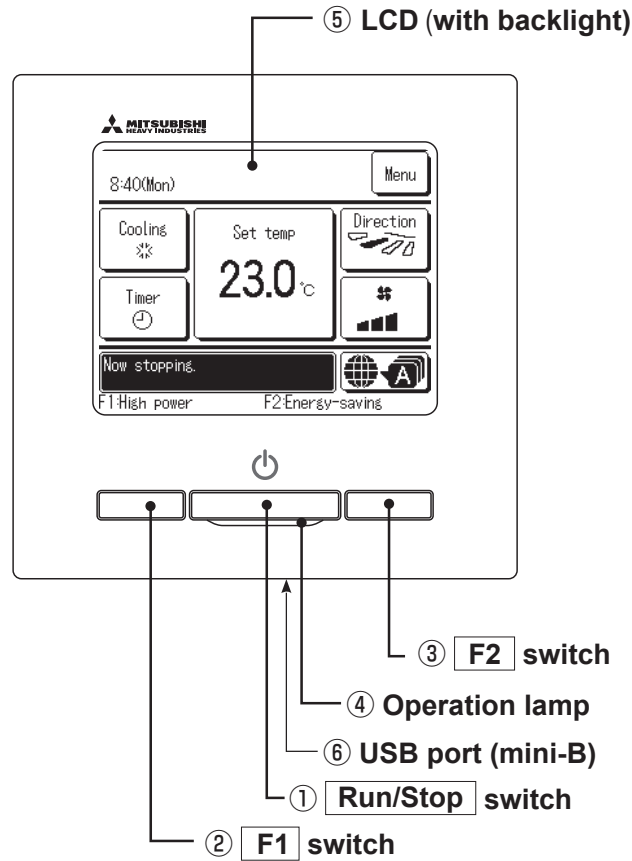

Touch panel system, which is operated by tapping the LCD screen with a finger, is employed for any operations other than the ①Run/Stop, ②F1 and ③F2 switches.

① Run/Stop switch

One push on the button starts operation and another push stops operation.

If the backlight is ON setting, when the screen is tapped while the backlight is turned off, the backlight only is turned on. (Operations with switches ①, ② and ③ are excluded.)

② F1 switch ③ F2 switch

This switch starts operation that is set in F1/F2 function change.

⑥ USB port

USB connector (mini-B) allows connecting to a personal computer.

④ Operation lamp

This lamp lights in green (yellow-green) during operation. It changes to red (orange) if any error occurs.

For operating methods, refer to the instruction manual attached to the software for personal computer (remote control utility software).

Operation lamp luminance can be changed.

Note(1) When connecting to a personal computer, do not connect simultaneously with other USB devices. Please be sure to connect to the computer directly, without going through a hub, etc.

⑤ LCD (with backlight)

A tap on the LCD lights the backlight.

The backlight turns off automatically if there is no operation for certain period of time. Lighting period of the backlight lighting can be changed.

Model RC-E5

The figure below shows the remote control with the cover opened. Note that all the items that may be displayed in the liquid crystal display area are shown in the figure for the sake of explanation. Characters displayed with dots in the liquid crystal display area are abbreviated.

The figure below shows the remote control with the cover opened.

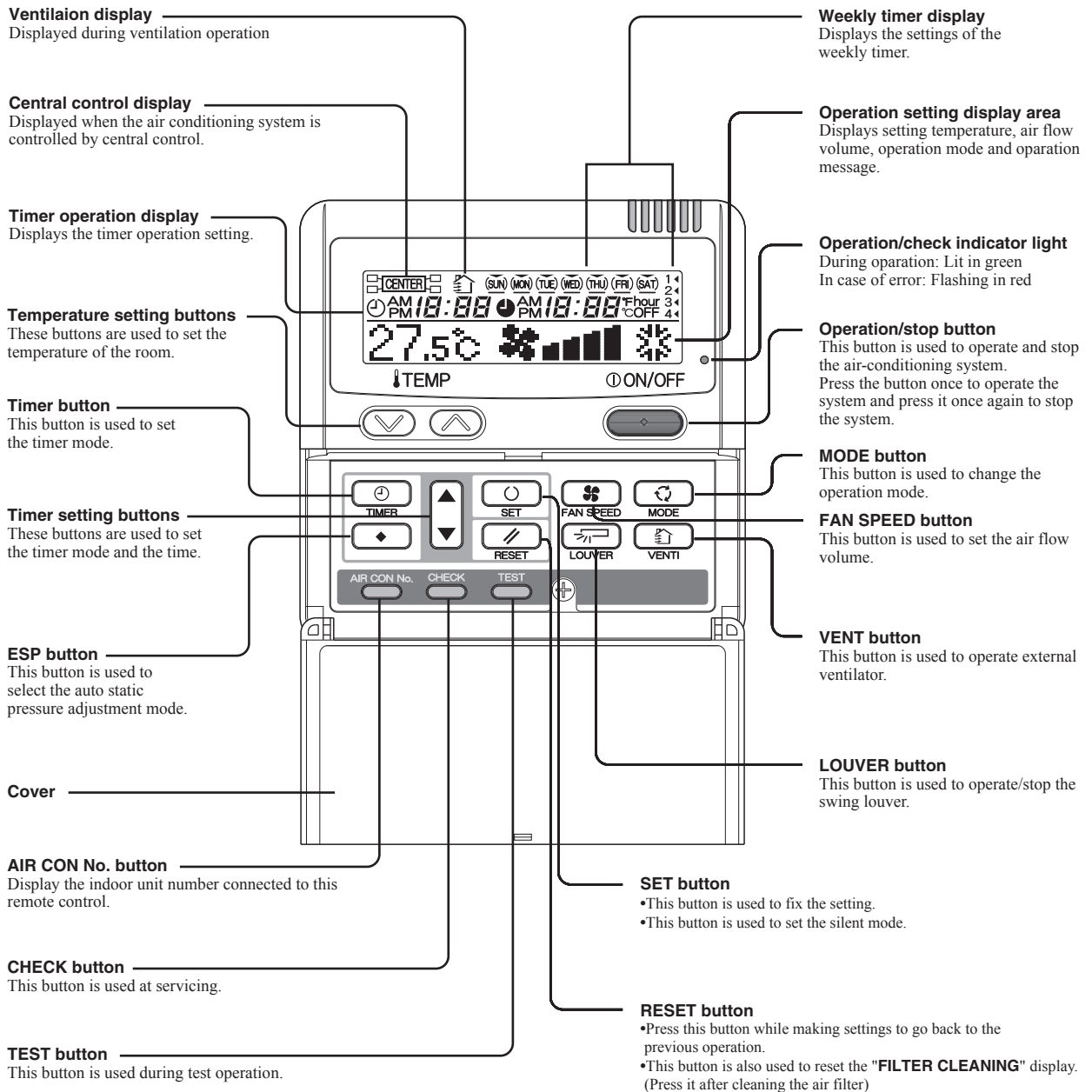

* All displays are described in the liquid crystal display for explanation.

1.2.2 Operation control function by the wired remote control

● Model RC-EX3A

(1) Switching sequence of the operation mode switches of remote control

- Tap the change operation mode button on the TOP screen.
- When the change operation mode screen is displayed, tap the button of desired mode.
- When the operation mode is selected, the display returns to the TOP screen.

Icons displayed have the following meanings.

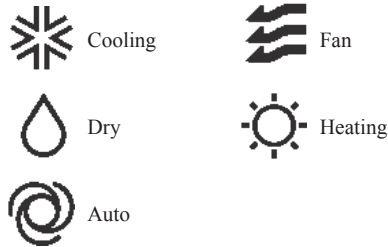

Notes(1) Operation modes which cannot be selected depending on combinations of indoor unit and outdoor unit are not displayed.

- When the Auto is selected, the cooling and heating switching operation is performed automatically according to indoor and outdoor temperatures.

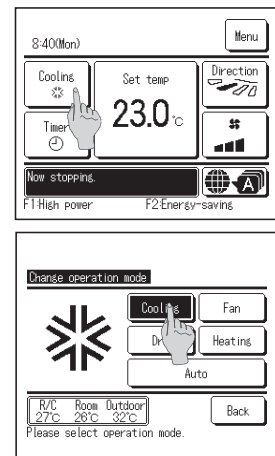

(2) CPU reset

Reset CPU from the remote control as follows.

TOP screen ⇒ ⇒ ⇒

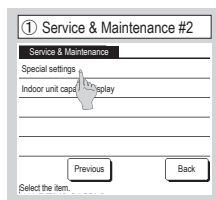

The selected screen is displayed.

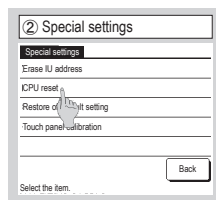

The selected screen is displayed.

Microcomputers of indoor unit and outdoor unit connected are reset (State of restoration after power failure).

(3) Power failure compensation function (Electric power source failure)

Enable the Auto-restart function from the remote control as follows.

TOP screen ⇒ ⇒ ⇒

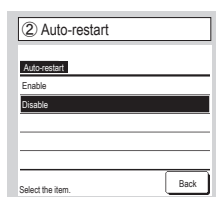
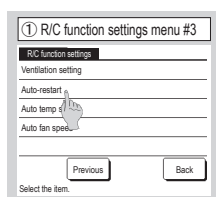

If the unit stops during operation,

It returns to the state before the power failure as soon as the power source is restored (After the end of the primary control at the power on).

It stops after the restoration of power source.

- Since the status of remote control is retained in memory always, it restarts operations according to the contents of memory as soon as the power source is restored. Although the timer mode is cancelled, the weekly timer, peak cut timer and silent mode timer operate according to the following contents:

- When the clock setting is valid : These timer settings are also valid.
- When the clock setting is invalid : These timer settings become “Invalid” since the clock setting is invalid. These timer settings have to be changed to “Valid” after the timer setting.

- Content memorized with the power failure compensation are as follows.

Note(1) Items (f) and (g) are memorized regardless whether the power failure compensation is effective or not while the setting of silent mode is cancelled regardless whether the power failure compensation is effective or not.

- (a) At power failure – Operating/stopped

If it had been operating under the off timer mode, sleep timer mode, the state of stop is memorized.

- (b) Operation mode

- (c) Air flow volume mode

- (d) Room temperature setting

- (e) Louver auto swing/stop

However, the stop position (4-position) is cancelled so that it returns to Position (1).

- (f) “Remote control function items” which have been set with the administrator or installation function settings (“Indoor function items” are saved in the memory of indoor unit.)

- (g) Weekly timer, peak-cut timer or silent mode timer settings

- (h) Remote control function setting

(4) Alert displays

If the following (a) to (c) appear, check and repair as follows.

(a) Communication check between indoor unit and remote control



- This appears if communications cannot be established between the remote control and the indoor unit.
Check whether the system is correctly connected (indoor unit, outdoor unit, remote control) and whether the power source for the outdoor unit is connected.

(b) Clock setting check

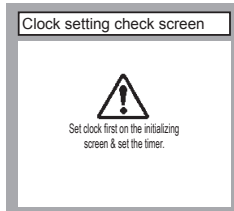

- This appears when the timer settings are done without clock setting.
Set the clock setting before the timer settings.

(c) Misconnection

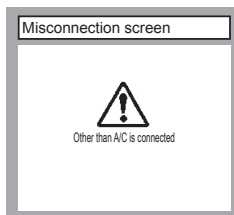

- This appears when something other than the air-conditioner has been connected to the remote control.
Check the location to which the remote control is connected.

● Model RC-E5

(1) Switching sequence of the operation mode switches of remote control



(2) CPU reset

This functions when “CHECK” and “ESP” buttons on the remote control are pressed simultaneously. Operation is same as that of the power source reset.

(3) Power failure compensation function (Electric power source failure)

- This becomes effective if “Power failure compensation effective” is selected with the setting of remote control function.
- Since it memorizes always the condition of remote control, it starts operation according to the contents of memory no sooner than normal state is recovered after the power failure. Although the auto swing stop position and the timer mode are cancelled, the weekly timer setting is restored with the holiday setting for all weekdays. After recovering from the power failure, it readjusts the clock and resets the holiday setting for each weekday so that the setting of weekly timer becomes effective.
- Content memorized with the power failure compensation are as follows.

Note (1) Items (f), (g) and (h) are memorized regardless whether the power failure compensation is effective or not while the setting of silent mode is cancelled regardless whether the power failure compensation is effective or not.

- (a) At power failure – Operating/stopped
If it had been operating under the off timer mode, sleep timer mode, the state of stop is memorized. (Although the timer mode is cancelled at the recovery from power failure, the setting of weekly timer is changed to the holiday setting for all weekdays.)
- (b) Operation mode
- (c) Air flow volume mode
- (d) Room temperature setting
- (e) Louver auto swing/stop
However, the stop position (4-position) is cancelled so that it returns to Position (1).
- (f) “Remote control function items” which have been set with the remote control function setting (“Indoor function items” are saved in the memory of indoor unit.)
- (g) Upper limit value and lower limit value which have been set with the temperature setting control
- (h) Sleep timer and weekly timer settings (Other timer settings are not memorized.)

[Parts layout on remote control PCB]

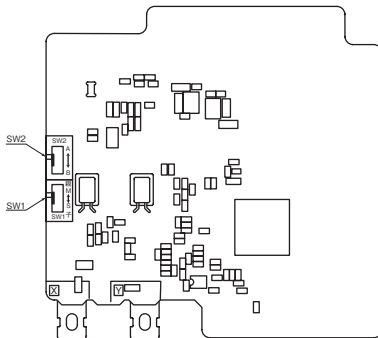

Master/ slave setting when more than one remote controls are used

A maximum of two remote controls can be connected to one indoor unit (or one group of indoor units.)

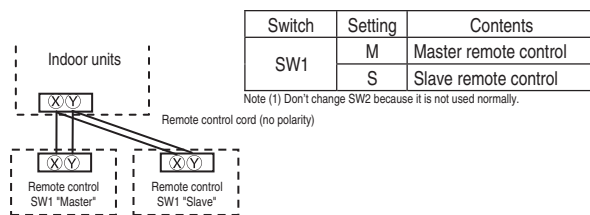

Caution

When using multiple remote controls, the following displays or settings cannot be done with the slave remote control. It is available only with the master remote control.

- ① Louver position setting (set upper or lower limit of swinging range)
- ② Setting indoor unit functions
- ③ Setting temperature range
- ④ Operation data display
- ⑤ Error data display
- ⑥ Silent mode setting
- ⑦ Test operation of drain pump
- ⑧ Remote control sensor setting

1.2.3 Operation control function by the indoor control

(1) Auto operation

- (a) If “Auto” mode is selected by the remote control, the heating and the cooling are automatically switched according to the difference between outdoor air temperature and setting temperature and the difference between setting temperature and return air temperature. (When the switching of cooling mode ↔ heating mode takes place within 3 minutes, the compressor does not operate for 3 minutes by the control of 3-minute timer.) This will facilitate the cooling/heating switching operation in intermediate seasons and the adaptation to unmanned operation at stores, etc (ATM corner of bank).

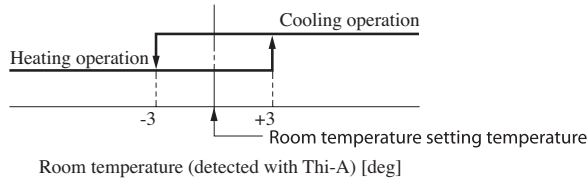

Notes (1) Temperature range of switching cooling/heating mode can be changed by RC-EX3A from ±1.0 – ±4.0.

- (2) Room temperature control during auto cooling/auto heating is performed according to the room temperature setting temperature. (DIFF: ±1 deg)
 (3) If the indoor heat exchanger temperature rises to 59°C or higher during heating operation, it is switched automatically to cooling operation. In addition, for 1 hour after this switching, the heating operation is not performed, regardless of the temperature shown at right.

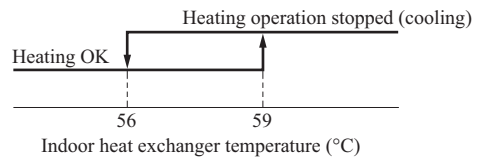

- (b) The following automatic controls are performed other than (a) above.

- (i) Cooling or heating operation mode is judged according to the conditions of the "Judgment based on Setting temperature + Cooling select temperature and Indoor return air temperature" and the "Judgment based on Outdoor temperature".

- 1) In " $\text{Setting temperature} - \text{Cooling select temperature} < \text{Indoor return air temperature}$ " and " $\text{Outdoor temperature}/\text{Cooling} < \text{Outdoor return air temperature}$ " ⇒ Operation mode: Cooling
- 2) " $\text{Setting temperature} + \text{Heating select temperature} > \text{Indoor return air temperature}$ " and " $\text{Outdoor temperature}/\text{Heating} > \text{Outdoor air temperature}$ " ⇒ Operation mode: Heating
- 3) The outdoor air temperature of the above judgment conditions is sampled at every 10 minutes.
- 4) In the range where the above cooling and heating zones are overlapped ⇒ Forced thermostat OFF

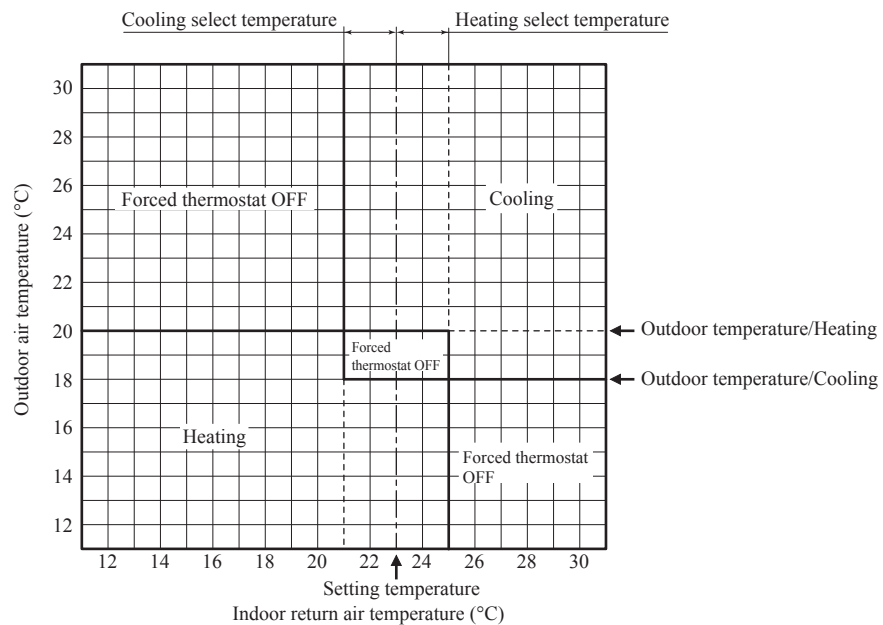

- (ii) Regardless of the setting temperature, the cooling or heating operation mode is judged according to the “Judgment based on Room temperature/Cooling or Heating and Outdoor temperature/Cooling or Heating”.
 - 1) In case of "Room temperature/Cooling < Indoor return air temperature" and "Outdoor temperature/Cooling < Outdoor air temperature" ⇒ Operation mode: Cooling
 - 2) In case of "Room temperature/Heating > Indoor return air temperature" and "Outdoor temperature /Heating > Outdoor air temperature" ⇒ Operation mode: Heating
 - 3) The outdoor air temperature of the above judgment conditions is sampled at every 10 minutes.
 - 4) In the range where the above cooling and heating zones are overlapped ⇒ Forced thermostat OFF

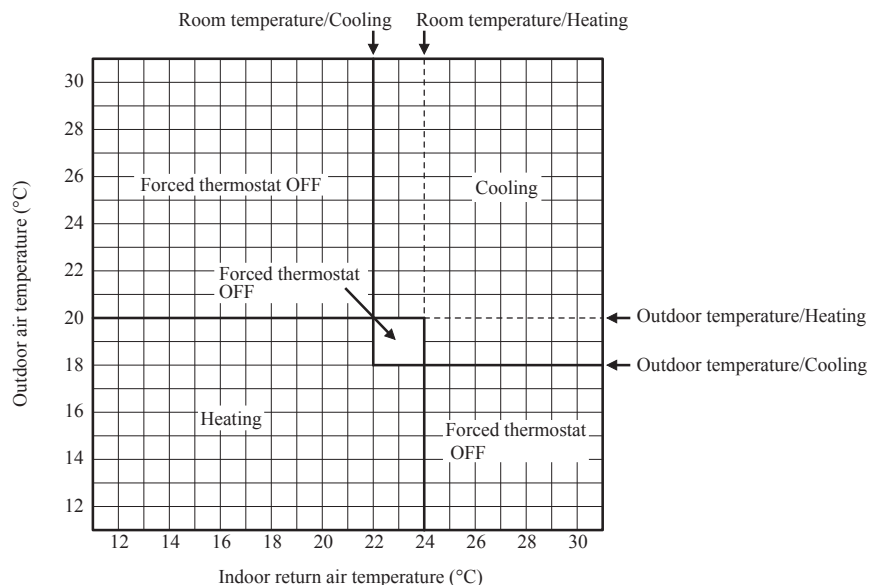

(2) Operations of functional items during cooling/heating

| Operation Functional item | Cooling | | Fan | Heating | | | Dehumidifying |
|------------------------------|---------------|------------------|------------------|--------------------|----------------|---------------------|--|
| | Thermostat ON | Thermostat OFF | | Thermostat ON | Thermostat OFF | Hot start (Defrost) | |
| Compressor | ○ | × | × | ○ | × | ○ | ○/× |
| 4-way valve | × | × | × | ○ | ○ | ○(×) | × |
| Outdoor unit fan | ○ | × | × | ○ | × | ○(×) | ○/× |
| Indoor unit fan | ○ | ○ | ○ | ○/× | ○/× | ○/× | ○/× |
| Drain pump ⁽³⁾ | ○ | × ⁽²⁾ | × ⁽²⁾ | ○/× ⁽²⁾ | | | Thermostat ON: ○ Thermostat OFF: × ⁽²⁾ |

Notes (1) ○: Operation ×: Stop ○/×: Turned ON/OFF by the control other than the room temperature control.
 (2) ON during the drain pump motor delay control.
 (3) Drain pump ON setting may be selected with the indoor unit function setting of the wired remote control.

(3) Dehumidifying (DRY) operation

Indoor ambient temperatures and humidity are controlled simultaneously with the relative humidity sensor (HS) and the suction temperature sensor [Thi-A (or the remote control temperature sensor when it is activated)], which are installed at the suction inlet.

- (i) When the operation has been started with cooling, if there is a difference of 2°C or less between the suction and setting temperatures, the tap of indoor fan is lowered by one tap. This tap is retained for 3 minutes after changing the tap.
- (ii) After the above condition, when a difference between suction and setting temperature is lower than 3°C, and the relative humidity is high, the tap of indoor unit fan is lowered by one tap.
 When the difference between suction and setting temperature is larger than 3°C, the fan of indoor unit fan is raised by one tap. This tap is retained for 3 minutes after changing the tap.
- (iii) When relative humidity becomes lower, the indoor unit fan tap is retained.
- (iv) In case of the thermostat OFF, the indoor unit fan tap at the thermostat ON is retained.

(4) Timer operation

(a) RC-EX3A

(i) Sleep timer

Set the time from the start to stop of operation. The time can be selected in the range from 30 to 240 minutes (in the unit of 10-minute).

Note (1) Enable the "Sleep timer" setting from the remote control. If the setting is enabled, the timer operates at every time.

(ii) Set OFF timer by hour

Set the time to stop the unit after operation, in the range from 1 to 12 hours (in the unit of hour).

(iii) Set ON timer by hour

Set the time to start the unit after the stop of operation, in the range from 1 to 12 hours (in the unit of hour). It is allowed also to set simultaneously the indoor temperature, operation mode, air flow rate and warm-up enabled/disabled.

(iv) Set ON timer by clock

Set the time to start operation. The time can be set in the unit of 5-minute. This setting can be activated only once or at every time. It is allowed also to set simultaneously the indoor temperature, operation mode, air flow rate and warm-up enabled/disabled.

Note (1) It is necessary to set the clock to use this timer.

(v) Set OFF timer by clock

Set the time to stop operation. The time can be set in the unit of 5-minute. This setting can be activated only once or at every time.

Note (1) It is necessary to set the clock to use this timer.

(vi) Weekly timer

Set the ON or OFF timer for a week. Up to 8 patterns can be set for a day. The day-off setting is provided for holidays and non-business days.

Note (1) It is necessary to set the clock to use the weekly timer.

(vii) Combination of patterns which can be set for the timer operations

| | Sleep time | Set OFF timer by hour | Set ON timer by hour | Set OFF timer by clock | Set ON timer by clock | Weekly timer |
|------------------------|------------|-----------------------|----------------------|------------------------|-----------------------|--------------|
| Sleep time | | × | × | ○ | ○ | ○ |
| Set OFF timer by hour | × | | × | × | × | × |
| Set ON timer by hour | × | × | | × | × | × |
| Set OFF timer by clock | ○ | × | × | | ○ | × |
| Set ON timer by clock | ○ | × | × | ○ | | × |
| Weekly timer | ○ | × | × | × | × | |

Notes (1) ○: Allowed ×: Not

(b) RC-E5

(i) Sleep timer

Set the duration of time from the present to the time to turn off the air-conditioner.

It can be selected from 10 steps in the range from "OFF 1 hour later" to "OFF 10 hours later". After the sleep timer setting, the remaining time is displayed with progress of time in the unit of hour.

(ii) OFF timer

Time to turn OFF the air-conditioner can be set in the unit of 10 minutes.

(iii) ON timer

Time to turn ON the air-conditioner can be set. Indoor temperature can be set simultaneously.

(iv) Weekly timer

Timer operation (ON timer, OFF timer) can be set up to 4 times a day for each weekday.

(v) Timer operations which can be set in combination

| Item | Item | Timer | OFF timer | ON timer | Weekly timer |
|--------------|------|-------|-----------|----------|--------------|
| Timer | | | × | ○ | × |
| OFF timer | × | | | ○ | × |
| ON timer | ○ | | ○ | | × |
| Weekly timer | × | × | × | × | |

Notes (1) ○: Allowed ×: Not

(2) Since the ON timer, sleep timer and OFF timer are set in parallel, when the times to turn ON and OFF the air-conditioner are duplicated, the setting of the OFF timer has priority.

(5) Hot start (Cold draft prevention at heating)**(a) Operating conditions**

When either one of following conditions is satisfied, the hot start control is performed.

- (i) From stop to heating operation
- (ii) From cooling to heating operation
- (iii) Form heating thermostat OFF to ON
- (iv) After completing the defrost operation (only on units with thermostat ON)

(b) Contents of operation**(i) Indoor fan motor control at hot start**

- 1) Within 7 minutes after starting heating operation, the fan mode is determined depending on the condition of thermostat (fan control with heating thermostat OFF).

a) Thermostat OFF

- i) Operates according to the fan control setting at heating thermostat OFF.
- ii) Even if it changes from thermostat OFF to ON, the fan continues to operate with the fan control at thermostat OFF till the heat exchanger temperature sensor (Thi-R1 or R2, whichever higher) detects 35°C or higher.
- iii) When the heat exchanger temperature sensor (Thi-R1 or R2, whichever higher) detects 35°C or higher, the fan operates with the set air flow volume.

b) Thermostat ON

- i) When the heat exchanger temperature sensor (Thi-R1 or R2, whichever higher) detects 25°C or lower, the fan is turned OFF and does not operate.
- ii) When the heat exchanger temperature sensor (Thi-R1 or R2, whichever higher) detects 25°C or higher, the fan operates with the fan control at heating thermostat OFF.
- iii) When the heat exchanger temperature sensor (Thi-R1 or R2, whichever higher) detects 35°C or higher, the fan operates with the set air flow volume.

- c) If the fan control at heating thermostat OFF is set at the “Set air flow volume” (from the remote control), the fan operates with the set air flow volume regardless of the thermostat ON/OFF.

- 2) Once the fan motor is changed from OFF to ON during the thermostat ON, the indoor fan motor is not turned OFF even if the heat exchanger temperature sensor detects lower than 25°C.

Note (1) When the defrost control signal is received, it complies with the fan control during defrost operation.

- 3) Once the hot start is completed, it will not restart even if the temperature on the heat exchanger temperature sensor drops.

(ii) During the hot start, the louver is kept at the horizontal position.

(iii) When the fan motor is turned OFF for 7 minutes continuously after defrost operation, the fan motor is turned ON regardless of the temperatures detected with the indoor heat exchanger temperature sensors (Thi-R1, R2).

(c) Ending condition

- (i) If one of following conditions is satisfied during the hot start control, this control is terminated, and the fan is operated with the set air flow volume.

1) Heat exchanger temperature sensor (Thi-R1 or R2, whichever higher) detects 35°C or higher.

2) It has elapsed 7 minutes after starting the hot start control.

(6) Hot keep

Hot keep control is performed at the start of the defrost operation.

(a) Control

(i) When the indoor heat exchanger temperature (detected with Thi-R1 or R2) drops to less than 35°C, the speed of indoor fan follows fan setting at the time of thermostat OFF.

(ii) During the hot keep, the louver is kept at the horizontal position.

(7) Auto swing control (FDTC and FDE only)

Note Even if [Auto Swing] is selected, the louver position with anti draft function is fixed to position 1.

(a) RC-EX3A**(i) Louver control**

- 1) To operate the swing louver when the air-conditioner is operating, press the “Direction” button on the TOP screen of remote control. The wind direction select screen will be displayed.
- 2) To swing the louver, touch the “Auto swing” button. The louver will move up and down. To fix the swing louver at a position, touch one of [1] - [4] buttons. The swing louver will stop at the selected position.
- 3) Louver operation at the power on with a unit having the louver 4-position control function
The louver swings one time automatically (without operating the remote control) at the power on.
This allows the microcomputer recognizing and inputting the louver motor (LM) position.



(ii) Automatic louver level setting during heating

At the hot start and the heating thermostat OFF, regardless whether the auto swing switch is operated or not (auto swing or louver stop), the louver takes the level position (in order to prevent blowing of cool wind). The louver position display LCD continues to show the display which has been shown before entering this control.

(iii) Louver free stop control

If you touch the “Menu” → “Next” → “R/C settings” buttons one after another on the TOP screen of remote control, the “Flap control” screen is displayed. If the free stop is selected on this screen, the louver motor stops upon receipt of the stop signal from the remote control. If the auto swing signal is received from the remote control, the auto swing will start from the position before the stop.

(b) RC-E5**(i) Louver control**

- 1) Press the “LOUVER” button to operate the swing louver when the air-conditioner is operating.
“SWING  ” is displayed for 3 seconds and then the swing louver moves up and down continuously.
- 2) To fix the swing louver at a position, press one time the “LOUVER” button while the swing louver is moving so that four stop positions are displayed one after another per second.
When a desired stop position is displayed, press the “LOUVER” button again. The display stops, changes to show the “STOP 1  ” for 5 seconds and then the swing louver stops.
- 3) Louver operation at the power on with a unit having the louver 4-position control function
The louver swings one time automatically (without operating the remote control) at the power on.
This allows inputting the louver motor (LM) position, which is necessary for the microcomputer to recognize the louver position.

Note (1) If you press the “LOUVER” button, the swing motion is displayed on the louver position LCD for 10 seconds. The display changes to the “SWING  ” display 3 seconds later.

(ii) Automatic louver level setting during heating

At the hot start with the heating thermostat OFF, regardless whether the auto swing switch is operated or not (auto swing or louver stop), the louver takes the level position (In order to prevent the cold start). The louver position display LCD continues to show the display which has been shown before entering this control.

(iii) Louver-free stop control

When the louver-free stop has been selected with the indoor function of wired remote control “ POSITION”, the louver motor stops when it receives the stop signal from the remote control. If the auto swing signal is received from the remote control, the auto swing will start from the position where it was before the stop.

Note (1) When the indoor function of wired remote control “ POSITION” has been switched, switch also the remote control function “ POSITION” in the same way.

(8) Thermostat operation**(a) Cooling**

- (i) Thermostat is operated with the room temperature control.
- (ii) Thermostat is turned ON or OFF relative to the set room temperature as shown below.

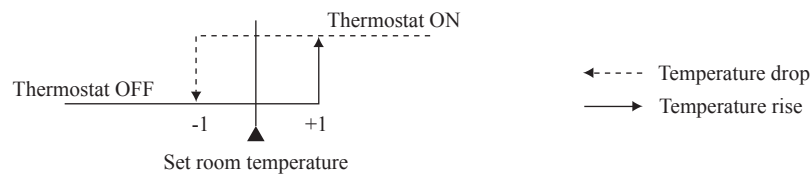

- (iii) Thermostat is turned ON when the room temperature is in the range of $-1 < \text{Set temperature} < +1$ at the start of cooling operation (including from heating to cooling).

(b) Heating

- (i) Thermostat is operated with the room temperature control.
- (ii) Thermostat is turned ON or OFF relative to the set room temperature as shown below.

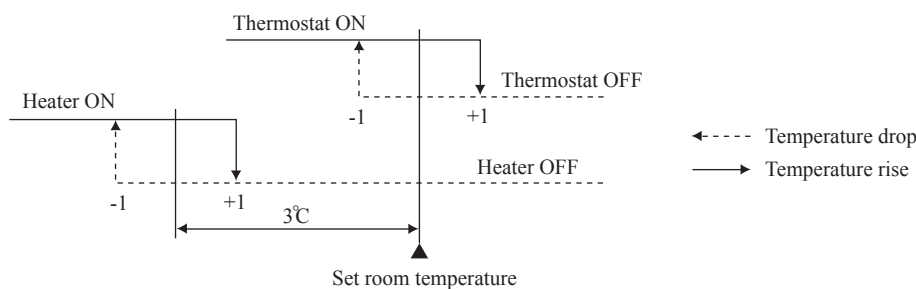

- (iii) Thermostat is turned ON when the room temperature is in the range of $-1 < \text{Set point} < +1$ at the start of heating operation (including from cooling to heating).

(c) Fan control during heating thermostat OFF

- (i) Following fan controls during the heating thermostat OFF can be selected with the indoor function setting of the wired remote control.
 - ① Low fan speed (Factory default), ② Set fan speed, ③ Intermittence, ④ Fan OFF
- (ii) When the “Low fan speed (Factory default)” is selected, the following taps are used for the indoor fans.
 - For DC motor : ULo tap
- (iii) When the “Set fan speed” is selected, it is operated with the set fan speed also in the thermostat OFF condition.
- (iv) If the “Intermittence” is selected, following controls are performed:
 - 1) If the thermostat is turned OFF during the heating operation, the indoor unit moves to the hot control and turns OFF the indoor fan if the heat exchanger temperature sensors (both Thi-R1 and R2) detect 25°C or lower.
 - 2) Indoor fan OFF is fixed for 5 minutes. After the 5 minutes, the indoor fan is operated at ULo for 2 minutes. In the meantime the louver is controlled at level.
 - 3) After operating at ULo for 2 minutes, the indoor fan moves to the state of 1) above.
 - 4) If the thermostat is turned ON, it moves to the hot start control.
 - 5) When the heating thermostat is turned OFF, the remote control displays the temperature detected at the fan stop and revises the temperature later when the indoor fan changes from ULo to stop. The remote control uses the operation data display function to display temperatures and updates values of temperature even when the indoor fan is turned OFF.
 - 6) When the defrost operation starts while the heating thermostat is turned OFF or the thermostat is turned OFF during defrost operation, the indoor fan is turned OFF. (Hot keep or hot start control takes priority.) However, the suction temperature is updated at every 7-minute.
 - 7) When the heating thermostat is turned ON or the operation is changed to another mode (including stop), this control is stopped immediately, and the operating condition is restored.
- (v) When the “Fan OFF” is selected, the fan on the indoor unit of which the thermostat has been turned OFF, is turned OFF. The same occurs also when the remote control sensor is effective.

(d) Fan control during cooling thermostat OFF

- (i) Following fan controls during the cooling thermostat OFF can be selected with the indoor function setting of the wired remote control.
- ① Low fan speed, ② Set fan speed (Factory default), ③ Intermittence, ④ Fan OFF
- (ii) When the “Low fan speed” is selected, the following taps are used for the indoor fans.
- For DC motor : ULo tap
- (iii) When the “Set fan speed” is selected, it is operated with the set fan speed also in the thermostat OFF condition.
- (iv) If the “Intermittence” is selected, following controls are performed:
- 1) If the thermostat is turned OFF during the cooling operation, the indoor fan motor stops.
 - 2) Indoor fan OFF is fixed for 5 minutes. After the 5 minutes, the indoor fan is operated at ULo for 2 minutes. In the meantime the louver is controlled at level.
 - 3) After operating at ULo for 2 minutes, the indoor fan moves to the state of 1) above.
 - 4) If the thermostat is turned ON, the fan starts operation at set fan speed.
 - 5) When the cooling thermostat is turned OFF, the remote control displays the temperature detected at the fan stop and revises the temperature later when the indoor fan changes from ULo to stop.
By using operation data display function at wireless remote control, the temperature as displayed and the value is updated including the fan stops.
 - 6) When the cooling thermostat is turned ON or the operation is changed to another mode (including stop), this control is stopped immediately, and the operating condition is restored.
- (v) When the “Fan OFF” is selected, the fan on the indoor unit of which the thermostat has been turned OFF, is turned OFF. The same occurs also when the remote control sensor is effective.

(9) Filter sign

As the operation time (Total ON time of ON/OFF switch) accumulates to 180 hours (1), “FILTER CLEANING” is displayed on the remote control. (This is displayed when the unit is in trouble and under the central control, regardless of ON/OFF.)

Notes (1) Time setting for the filter sign can be made as shown below using the indoor function of wired remote control “Filter sign”. (It is set at setting 1 at the shipping from factory.)

| Filter sign setting | Function |
|---------------------|--|
| Setting 1 | Setting time: 180 hrs (Factory default) |
| Setting 2 | Setting time: 600 hrs |
| Setting 3 | Setting time: 1,000 hrs |
| Setting 4 | Setting time: 1,000 hrs (Unit stop) ⁽²⁾ |

(2) After the setting time has elapsed, the “FILTER CLEANING” is displayed and, after operating for 24 hours further (counted also during the stop), the unit stops.

(10) Compressor inching prevention control**(a) 3-minute timer**

When the compressor has been stopped by the thermostat, remote control operation switch or anomalous condition, its restart will be inhibited for 3 minutes. However, the 3-minute timer is invalidated at the power on the electric power source for the unit.

(b) 3-minute forced operation timer

- (i) Compressor will not stop for 3 minutes after the compressor ON. However, it stops immediately when the unit is stopped by means of the ON/OFF switch or when the thermostat turned OFF by the change of operation mode.
- (ii) If the thermostat is turned OFF during the forced operation control of heating compressor, the louver position (with the auto swing) is returned to the level position.

Note (1) The compressor stops when it has entered the protective control.

(11) Drain pump control

- (a) This control is operated when the inverter frequency is other than 0 Hz during the cooling operation and automatic cooling and dehumidifying operations.
- (b) Drain pump ON condition continues for 5 minutes even when it enters the OFF range according to (i) above after turning the drain pump ON, and then stops. The 5-minute delay continues also in the event of anomalous stop.
- (c) The drain pump is operated with the 5-minute delay operation when the compressor is changed from ON to OFF.
- (d) Even in conditions other than the above (such as heating, fan, stop, cooling thermostat OFF), the drain pump control is performed by the drain detection.
- (e) Following settings can be made using the indoor function setting of the wired remote control.
 - (i) ㊦ [Standard (in cooling & dry)] : Drain pump is run during cooling and dry.
 - (ii) ㊦AND㊦ [Operate in standard & heating] : Drain pump is run during cooling, dry and heating.
 - (iii) ㊦AND㊦AND㊦ [Operate in heating & fan] : Drain pump is run during cooling, dry, heating and fan.
 - (iv) ㊦AND㊦ [Operate in standard & fan] : Drain pump is run during cooling, dry and fan.

Note (1) Values in [] are for the RC-EX3A model.

(12) Drain pump motor (DM) control

- (a) Drain detection switch is turned ON or OFF with the float switch (FS) and the timer.

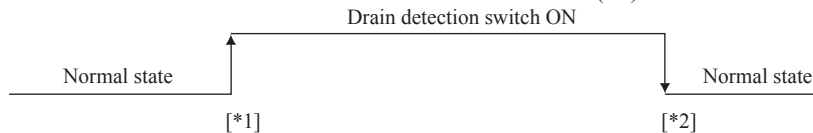

[*1] Drain detection switch is turned “ON” when the float switch “Open” is detected for 3 seconds continuously in the drain detectable space.

[*2] Drain detection switch is turned “OFF” when the float switch “Close” is detected for 10 seconds continuously.

- (i) It detects always from 30 seconds after turning the power ON.
 - 1) There is no detection of anomalous draining for 10 seconds after turning the drain pump OFF.
 - 2) Turning the drain detection switch “ON” causes to turn ON the drain pump forcibly.
 - 3) Turning the drain detection switch “OFF” releases the forced drain pump ON condition.
- (b) Indoor unit performs the control A or B depending on each operating condition.

| | Indoor unit operation mode | | | | |
|----------------|----------------------------|-----------|-----|--------------------|---------|
| | Stop ⁽¹⁾ | Cooling | Dry | Fan ⁽²⁾ | Heating |
| Compressor ON | | Control A | | | |
| Compressor OFF | | Control B | | | |

Notes (1) Including the stop from the cooling, dehumidifying, fan and heating, and the anomalous stop
 (2) Including the “Fan” operation according to the mismatch of operation modes

- (i) Control A
 - 1) If the float switch detects any anomalous draining condition, the unit stops with the anomalous stop (displays E9) and the drain pump starts. After detecting the anomalous condition, the drain pump motor continues to be ON.
 - 2) It keeps operating while the float switch is detecting the anomalous condition.
- (ii) Control B

If the float switch detects any anomalous drain condition, the drain pump motor is turned ON for 5 minutes, and at 10 seconds after the drain pump motor OFF it checks the float switch. If it is normal, the unit is stopped under the normal mode or, if there is any anomalous condition, E9 is displayed and the drain pump motor is turned ON. (The ON condition is maintained during the drain detection.)

(13) Operation check/drain pump test run operation mode

- (a) If the power is turned on by the DIP switch (SW7-1) on the indoor unit control PCB when electric power source is supplied, it enters the mode of operation check/drain pump test run. It is ineffective (prohibited) to change the switch after turning power on.
- (b) When the communication with the remote control has been established within 60 seconds after turning power on by the DIP switch (SW7-1) ON, it enters the operation check mode. Unless the remote control communication is established, it enters the drain pump test run mode.

Note (1) To select the drain pump test run mode, disconnect the remote control connector (CNB) on the indoor unit PCB to shut down the remote control communication.

(c) Operation check mode

There is no communication with the outdoor unit but it allows performing operation in respective modes by operating the remote control.

(d) Drain pump test run mode

As the drain pump test run is established, the drain pump only operates and during the operation protective functions by the microcomputer of indoor unit become ineffective.

(14) Cooling, dehumidifying frost protection

- (a) To prevent frosting during cooling mode or dehumidifying mode operation, the thermostat-OFF if the indoor heat exchanger temperature (detected with Thi-R) drops to 1.0 °C or lower at 4 minutes after the thermostat-ON. If the indoor unit heat exchanger temperature is 1.0 °C or lower after 5 minutes, the indoor unit is controlled thermostat-OFF. If it becomes 10°C or higher, the control terminates. When the indoor heat exchanger temperature has become as show, the indoor unit send outdoor unit the “Anti-frost” signal.

- Frost prevention temperature setting can be selected with the indoor unit function setting of the wired remote control.

| Item | Symbol | A |
|-------------------------------------|--------|-----|
| Temperature - Low (Factory default) | | 1.0 |
| Temperature - High | | 2.5 |

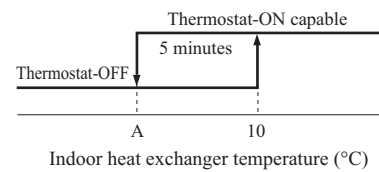

(b) Selection of indoor fan speed

If it enters the frost prevention control during cooling operation (excluding dehumidifying), the indoor fan speed is switched.

- When the indoor return air detection temperature (detected with Thi-A) is 23°C or higher and the indoor heat exchanger temperature (detected with Thi-R) detects the compressor frequency drop start temperature $A^{\circ}C+1^{\circ}C$, of indoor fan speed is increased by 20min^{-1} .
- If the phenomenon of (i) above is detected again after the acceleration of indoor fan, indoor fan speed is increased further by 20min^{-1} .

Note (1) Indoor fan speed can be increased by up to 2 taps.

- Compressor frequency drop start temperature (FDTC only)

$H_s > 50\%$

| Symbol | Item | Low | High |
|--------|------|-----|------|
| A | | 1.0 | 2.5 |
| B | | 2.5 | 4.0 |

$H_s \leq 50\%$

| Symbol | Item | Low | High |
|--------|------|------|------|
| A | | -0.5 | 1.0 |
| B | | 1.0 | 2.5 |

Note (1) Frost prevention temperature setting can be selected with the indoor unit function setting of the wired remote control.

(15) Heating overload protection

- (a) If the indoor heat exchanger temperature (detected with Thi-R) at 63°C or higher is detected for 2 seconds continuously, the compressor stops. When the compressor is restarted after a 3-minute delay, if a temperature at 63°C or higher is detected for 2 seconds continuously within 60 minutes after initial detection and if this is detected 5 times consecutively, the compressor stops with the anomalous stop (E8). Anomalous stop occurs also when the indoor heat exchanger temperature at 63°C or higher is detected for 6 minutes continuously.

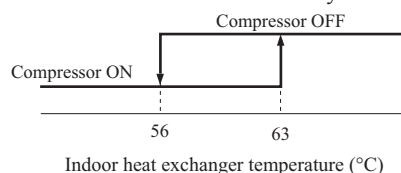

(b) Indoor fan speed selection

If, after second detection of heating overload protection up to fourth, the indoor fan is set at below Hi tap when the compressor is turned ON, the indoor fan speed is increased by 1 tap.

(16) Anomalous fan motor

- After starting the fan motor, if the fan motor speed is 200min^{-1} or less is detected for 30 seconds continuously and 4 times within 60 minutes, then fan motor stops with the anomalous stop (E16).
- If the fan motor fails to reach at -50min^{-1} less than the required speed, it stops with the anomalous stop (E20).

(17) Plural unit control – Control of 16 units group by one remote control

(a) Function

One remote control can control a group of multiple number of unit (Max. 16 indoor units). “Operation mode” which is set by the remote control can operate or stop all units in the group one after another in the order of unit. No.⁽¹⁾. Thermostat and protective function of each unit function independently.

Note (1) Unit No. is set by SW2 on the indoor unit control PCB. Unit No. setting by SW2 is necessary for the indoor unit only.
SW2: For setting of 0 – 9, A – F

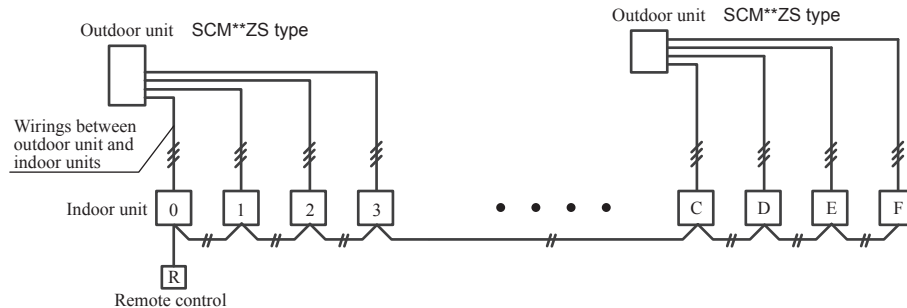

(2) Unit No. may be set at random unless duplicated, it should be better to set orderly like 0, 1, 2..., F to avoid mistake.

(b) Display to the remote control

- (i) Central or each remote control basis, heating preparation

The smallest unit No. among the operating units in the remote mode (or the center mode unless the remote mode is available) is displayed.

- (ii) Inspection display, filter sign

Any of unit that starts initially is displayed.

(c) Confirmation of connected units

- (i) In case of RC-EX3A remote control

If you touch the buttons in the order of “Menu” → “Service setting” → “Service & Maintenance” → “Service password” → “IU address” on the TOP screen of remote control, the indoor units which are connected are displayed.

- (ii) In case of RC-E5 remote control

Pressing “AIR CON No.” button on the remote control displays the indoor unit address. If “▲” “▼” button is pressed at the next, it is displayed orderly starting from the unit of smallest No.

(d) In case of anomaly

If any anomaly occurs on a unit in a group (a protective function operates), that unit stops with the anomalous stop but any other normal units continue to run as they are.

(e) Signal wiring procedure

Signal wiring between indoor and outdoor units should be made on each unit same as the normal wiring. For the group control, connect the remote control wiring to each indoor unit via terminal block for the remote control.

Connect the remote control wiring separately from the power source cable or wires of other electric devices (AC220V or higher).

(18) High ceiling control

When sufficient air flow rate cannot be obtained from the indoor unit which is installed at a room with high ceiling, the air flow rate can be increased by changing the fan tap. To change the fan tap, use the indoor unit function “FAN SPEED SET” on the wired remote control.

| Fan tap | | Indoor unit air flow setting | | | |
|---------------|----------------|------------------------------|----------------|-----------|-----------|
| | | - - - | - - | - | - |
| FAN SPEED SET | STANDARD | P-Hi - Hi - Me- Lo | Hi - Me - Lo | Hi - Lo | Hi - Me |
| | HIGH SPEED1, 2 | P-Hi - P-Hi - Hi - Me | P-Hi - Hi - Me | P-Hi - Me | P-Hi - Hi |

Notes (1) Factory default is STANDARD.

(2) At the hot-start and heating thermostat OFF, or other, the indoor fan is operated at the low speed tap of each setting.

(3) This function is not able to be set with wireless remote controls or simple remote control (RCH-E3)

(19) Abnormal temperature sensor (return air/indoor heat exchanger) broken wire/short-circuit detection

(a) Broken wire detection

When the return air temperature sensor detects -55°C or lower or the heat exchanger temperature sensor detect -55°C or lower for 5 seconds continuously, the compressor stops. After a 3-minute delay, the compressor restarts but, if it is detected again within 60 minutes after the initial detection for 6 minutes continuously, stops again (the return air temperature sensor: E7, the heat exchanger temperature sensor: E6).

(b) Short-circuit detection

If the heat exchanger temperature sensor detects short-circuit for 5 seconds continuously at 2 minutes and 20 seconds after the compressor ON during cooling operation, the compressor stops (E6).

(20) External input/output control (CnT or CnTA)

External input/output connectors are provided on the indoor unit control PCB, and each input/output is possible to be changed by RC-EX3A.

Be sure to connect the wired remote control to the indoor unit. Remote operation with CnT/CnTA only is not possible.

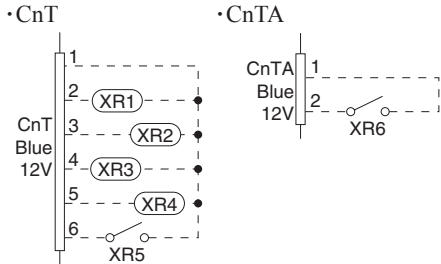

| Input/Output | Connector | Factory default setting | RC-EX3A function name |
|--------------------------------|-------------|--------------------------|-----------------------|
| Output | CnT-2 (XR1) | Operation output | External output 1 |
| | CnT-3 (XR2) | Heating output | External output 2 |
| | CnT-4 (XR3) | Compressor ON output | External output 3 |
| | CnT-5 (XR4) | Inspection(Error) output | External output 4 |
| "Input (Volt-free contact)" | CnT-6 (XR5) | Remote operation input | External input 1 |
| | CnTA (XR6) | Remote operation input | External input 2 |

■ Priority order for combinations of CnT and CnTA input.

| | | CnTA | | | | | |
|-----|--|------------------------|------------------------|------------------------------------|--|-----------------------------------|-----------------------------------|
| | | ① Operation stop level | ② Operation stop pulse | ③ Operation permission/prohibition | ④ Operation permission/prohibition pulse | ⑤ Cooling/heating selection level | ⑥ Cooling/heating selection pulse |
| CnT | ① Operation stop level | CnT ① | CnT ① | CnT ① + CnTA ② | CnT ① | CnT ① / CnTA ⑤ | CnT ① / CnTA ⑥ |
| | ② Operation stop pulse | CnT ② | CnT ② | CnT ② + CnTA ③ | CnT ② | CnT ② / CnTA ⑤ | CnT ② / CnTA ⑥ |
| | ③ Operation permission/prohibition level | CnT ③ > CnTA ① | CnT ③ > CnTA ② | CnT ③ + CnTA ③ | CnT ③ | CnT ③ / CnTA ⑤ | CnT ③ / CnTA ⑥ |
| | ④ Operation permission/prohibition pulse | CnT ④ | CnT ④ | CnT ④ + CnTA ③※ | CnT ④ | CnT ④ / CnTA ⑤ | CnT ④ / CnTA ⑥ |
| | ⑤ Cooling/heating selection level | CnT ⑤ / CnTA ① | CnT ⑤ / CnTA ② | CnT ⑤ / CnTA ③ | CnT ⑤ / CnTA ④ | CnT ⑤ | CnT ⑤ |
| | ⑥ Cooling/heating selection pulse | CnT ⑥ / CnTA ① | CnT ⑥ / CnTA ② | CnT ⑥ / CnTA ③ | CnT ⑥ / CnTA ④ | CnT ⑥ | CnT ⑥ |

Note (1) Following operation commands are accepted when the operation prohibition is set with CnTA as indicated with *.

Individual operation command from remote control, test run command from outdoor unit and operation command from option device, CnT input.

Reference: Explanation on the codes and the combinations of codes in the table above

- In case of CnT "Number", the CnT "Number" is adopted and CnTA is invalidated.
- In case of CnTA "Number", the CnTA "Number" is adopted and CnT is invalidated.
- In case of CnT "Number"/CnTA "Number", the CnT "Number" and the CnTA "Number" become independent functions each other.
- In case of CnT "Number" + CnTA "Number", the CnT "Number" and the CnTA "Number" become competing functions each other.
- In case of CnT "Number" > CnTA "Number", the function of CnT "Number" supersedes that of CnTA "Number".
- In case of CnT "Number" < CnTA "Number", the function of CnTA "Number" supersedes that of CnT "Number".
(The "Number" above means ① - ⑥ in the table.)

(a) Output for external control (remote display)

Indoor unit outputs the following signal for operation status monitoring.

| | Output name | Condition |
|----|-----------------------------------|--|
| 1 | Operation output | During operation |
| 2 | Heating output | During heating operation |
| 3 | Compressor ON output | During compressor operation |
| 4 | Inspection(Error) output | When anomalous condition occurs. |
| 5 | Cooling output | During cooling operation |
| 6 | Fan operation output 1 | When indoor unit's fan is operating |
| 7 | Fan operation output 2 | When indoor unit's fan is operating, and fan speed is higher than Hi speed. |
| 8 | Fan operation output 3 | When indoor unit's fan is operating, and fan speed is Lower than Me speed. |
| 9 | Defrost/oil return output | When indoor unit receive defrost/oil return signal from the outdoor unit. |
| 10 | Ventilation output | When "Venti.ON" is selected from remote control |
| 11 | Free cooling output | When the ambient temperature is between 10 - 18°C in cooling and fan operation |
| 12 | Indoor unit overload alarm output | Refer to "IU overload alarm" |
| 13 | Heater output | Refer to "(8) Thermostat operation (b) Heating" |

(b) Input for external control

The external input for the indoor unit can be selected from the following input.

| | Input name | Content |
|---|---------------------------|--|
| 1 | Run/Stop | Refer to [(20) (c) Remote operation input] |
| 2 | Permission/Prohibition | Refer to [(21) Operation permission/prohibition] |
| 3 | Cooling/Heating | Refer to [(23) Selection of cooling/heating external input function] |
| 4 | Emergency stop | Indoor/outdoor units stop the operation, and [E63] is displayed. |
| 5 | Setting temperature shift | Set temperature is shifted by +2/-2°C in cooling/heating. |
| 6 | Forced thermo-OFF | Unit goes thermo off. |
| 7 | Temporary stop | Refer to [(22) Temporary stop input] |
| 8 | Silent mode | Outdoor unit silent mode is activated. |

(i) In case of “Level input” setting (Factory default)

Input signal to CnT-6 or CnTA is OFF→ON unit ON

Input signal to CnT-6 or CnTA is ON→OFF unit OFF

Operation is not inverted.

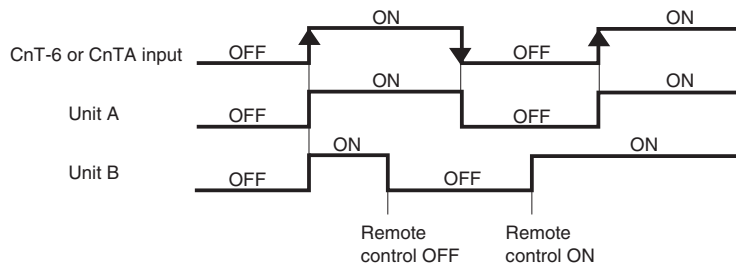

Note (1) The latest operation has priority.

It is available to operate/stop by remote control or central control.

(ii) In case of “Pulse input” setting (Local setting)

It is effective only when the input signal to CnT-6 or CnTA is changed OFF→ON, and at that time unit operation [ON/OFF] is inverted.

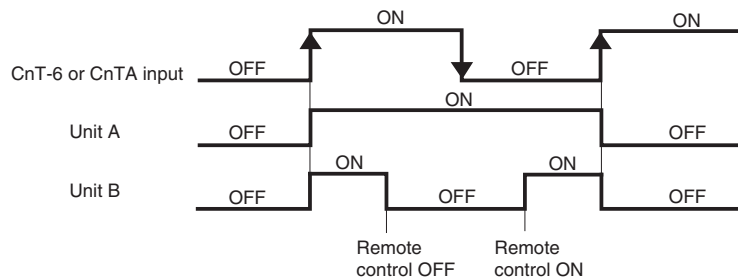

(c) Remote operation

(i) In case of multiple units (Max. 16 indoor units group) are connected to one wired remote control

When the R/C function setting of wired remote control for “External control set” is changed from “Individual (Factory default)” to “For all units”, all units connected in one wired remote control system can be controlled by external operation input.

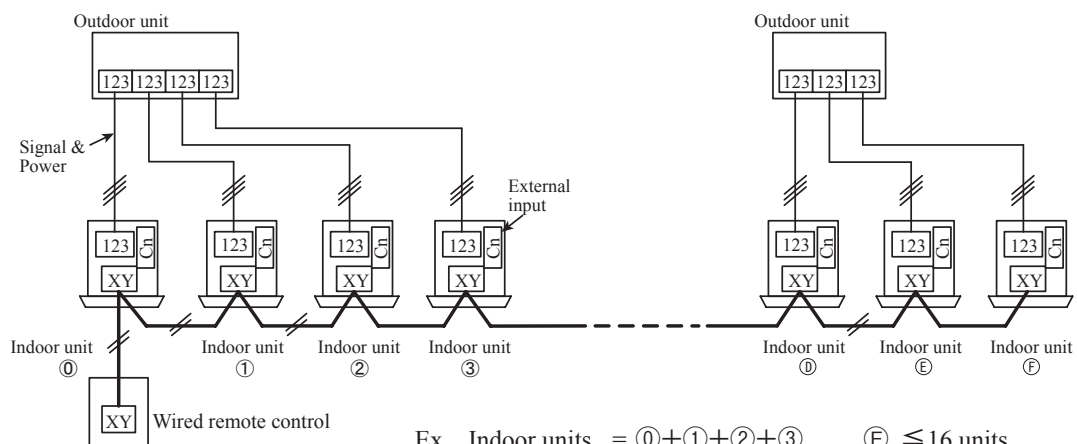

| CnT-6 or CnTA | Individual operation (Factory default) | | All units operation (Local setting) | |
|---------------|---|--|---|--|
| | ON | OFF | ON | OFF |
| | Only the unit directly connected to the remote control can be operated. | Only the unit directly connected to the remote control can be stopped operation. | All units in one remote control system can be operated. | All units in one remote control system can be stopped operation. |
| | Unit ① only | Unit ① only | Units ① – ㉞ | Units ① – ㉞ |

When more than one indoor unit (Max. 16 indoor units) are connected in one wired remote control system:

- (1) With the factory default, external input to CnT-6 or CnTA is effective for only the unit ①.
- (2) When setting “For all unit” (Local setting), all units in one remote control system can be controlled by external input to CnT-6 or CnTA on the indoor unit ①.
- (3) External input to CnT-6 or CnTA on the other indoor unit than the unit ① is not effective.

(21) Operation permission/prohibition

(In case of adopting card key switches or commercially available timers)

When the indoor function setting of wired remote control for “Operation permission/prohibition” is changed from “Invalid (Factory default)” to “Valid”, following control becomes effective.

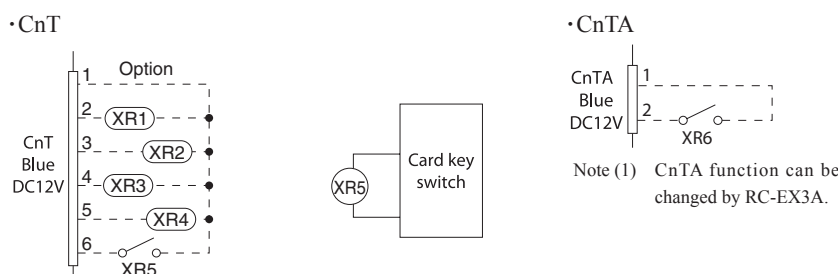

| CnT-6 or CnTA | Normal operation (Factory default) | | Operation permission/prohibition mode “Valid” (Local setting) | |
|---------------|------------------------------------|------|---|------------------------------------|
| | ON | OFF | ON | OFF |
| | Operation | Stop | Operation permission*1 | Operation prohibition (Unit stops) |

*1 **Only the “LEVEL INPUT” is acceptable for external input**, however when the indoor function setting of “Level input (Factory default)” or “Pulse input” is selected by the function for “External input” of the wired remote control, operation status will be changed as follows.

| In case of “Level input” setting | In case of “Pulse input” setting |
|--|----------------------------------|
| Unit operation from the wired remote control becomes available*(1) | Unit starts operation *(2) |

* (1) In case that “Operation permission/prohibition mode” setting is “Valid” and “External input” setting is “Level input (Factory default)”;

- ① When card key switch is ON (CnT-6 or CnTA ON: Operation permission), start/stop operation of the unit from the wired remote control becomes available.
- ② When card key switch is OFF (CnT-6 or CnTA OFF: Operation prohibition), the unit stops operation in conjunction with OFF signal, and start/stop operation of the unit from the wired remote control becomes unavailable.

* (2) In case that “Operation permission/prohibition mode” setting is “Valid” and “External input” setting is “Pulse input (Local setting)”;

- ① When card key switch is ON (Operation permission), the unit starts operation in conjunction with ON signal, and also start/stop operation of the unit from the wired remote control becomes available.
- ② When card key switch is OFF (Operation prohibition), the unit stops operation in conjunction with OFF signal, and start/stop operation of the unit from the wired remote control becomes unavailable.

(3) This function is invalid only at “Center mode” setting done by central control.

(a) In case of CnT ① Operation stop level > CnTA ③ Operation permission/prohibition level

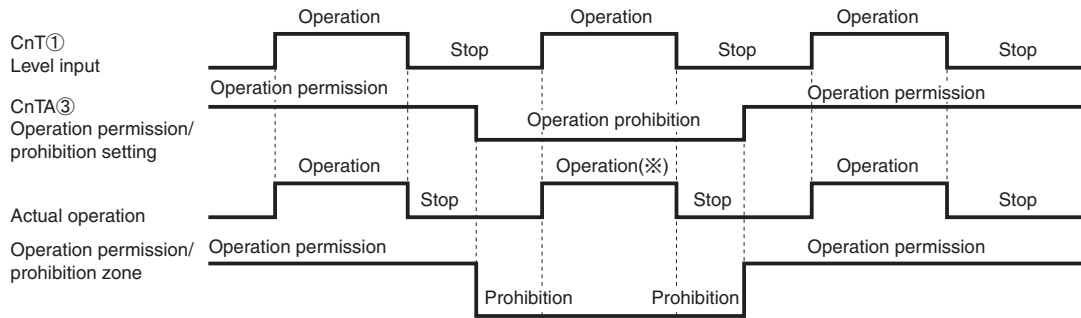

(※) CnT level input supersedes CnTA operation prohibition.

(b) In case of CnT ③ Operation permission/prohibition level + CnTA ③ Operation permission/prohibition level

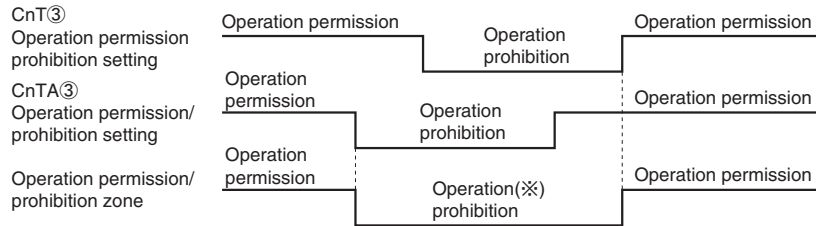

(※) Operation prohibition zone is determined by the OR judgment between CnT operation prohibition zone and CnTA operation prohibition zone.

(c) In case of CnT ③ Operation permission/prohibition level > CnTA ② Operation/stop pulse

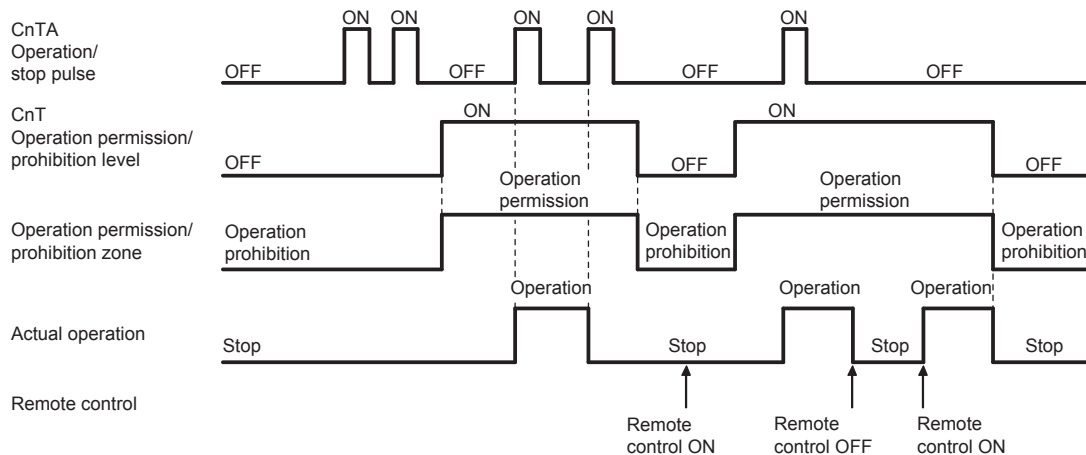

Note (1) If it is prohibited by CnT, all "Operation" and "Stop" commands are not accepted.

(d) In case of CnT ② Operation/stop pulse + CnTA ③ Operation permission/prohibition level

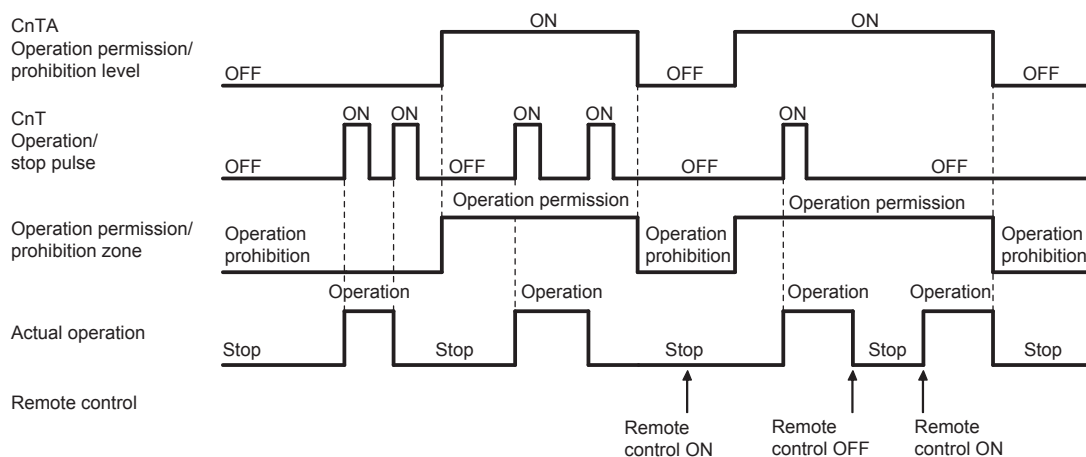

(22) Temporary stop input

In case of temporary stop, operation lamp of remote control lights, but indoor/outdoor unit stop the operation.

(a) In case of “level input” setting (Factory default)

Input signal to CnT-6 or CnTA is OFF → ON : Temporary stop
 Input signal to CnT-6 or CnTA is OFF → ON : Normal operation

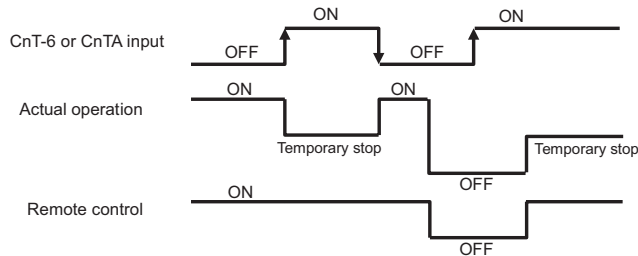

(b) In case of “pulse input” setting (Local setting)

It is effective only when the input signal is changed OFF→ON, and “temporary stop/normal operation” is inverted.

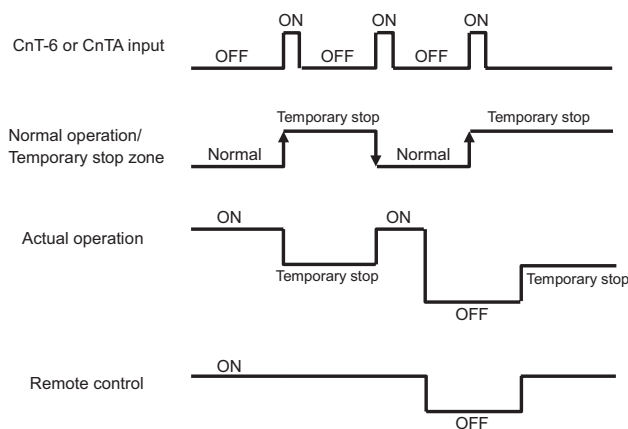

(23) Selection of cooling/heating external input function

- (a) When “External input 1 setting: Cooling/heating” is set by the indoor unit function from remote control, the cooling or heating is selected with CnT-6 or CnTA.
- (b) When the external input 1 method selection: Level input is set by the indoor unit function:
 - CnT-6 or CnTA: OPEN → Cooling operation mode
 - CnT-6 or CnTA: CLOSE → Heating operation mode
- (c) When the external input 1 method selection: Pulse input is set by the indoor unit function:
 - If the external input is changed OPEN → CLOSE, operation modes are inverted (Cooling → Heating or Heating → Cooling).
- (d) If the cooling/heating selection signal is given by the external input, the operation mode is transmitted to the remote control.

■ Selection of cooling/heating external input function

| External input selection | External input method | Operation | |
|---|-----------------------|---------------------------------------|--|
| External input selection Cooling/heating selection | ⑤ Level | External terminal input (CnT or CnTA) | |
| | | Cooling/heating | |
| | ⑥ Pulse | External terminal input (CnT or CnTA) | |
| | | Cooling/heating | |
| | | Cooling/heating (Competitive) | |

Note (1) Regarding the priority order for combinations of CnT and CnTA, refer to Page 58.

(24) Fan control at heating startup**(a) Starting conditions**

At the start of heating operation, if the difference of setting temperature and return air temperature is 5°C or higher after the end of hot start control, this control is performed.

(b) Contents of control

- (i) Sampling is made at each minute and, when the indoor heat exchanger temperature (detected with Thi-R) is 37°C or higher, present number of revolutions of indoor fan speed is increased by 10min⁻¹.
- (ii) If the indoor heat exchanger temperature drops below 37°C at next sampling, present number of revolutions of indoor fan speed is reduced by 10min⁻¹.

(c) Ending conditions

Indoor fan speed is reduced to the setting air flow volume when the compressor OFF is established and at 30 minutes after the start of heating operation.

(25) Room temperature detection temperature compensation during heating

With the standard specification, the compressor is turned ON/OFF with the thermostat setting temperature. When the thermostat is likely to turn OFF earlier because the unit is installed at the ceiling where warm air tends to accumulate, the setting can be changed with the wired remote control indoor unit function “※ SP OFFSET”. The compressor and the heater are turned ON/OFF at one of the setting temperature +3, +2 or +1°C in order to improve the feeling of heating. The setting temperature, however, has the upper limit of 30°C.

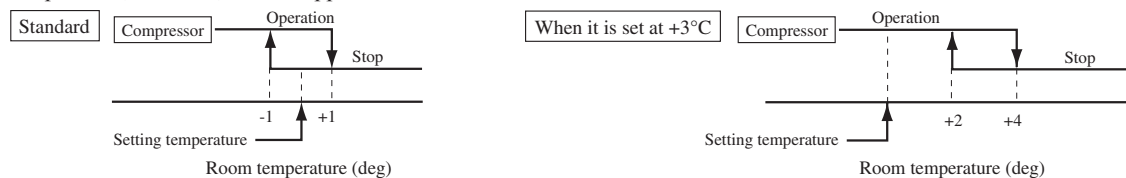
**(26) Return air temperature compensation**

This is the function to compensate the deviation between the detection temperature by the return air temperature sensor and the measured temperature after installing the unit.

- (a) It is adjustable in the unit of 0.5°C with the wired remote control indoor unit function “RETURN AIR TEMP”.
 - +1.0°C, +1.5°C, +2.0°C
 - -1.0°C, -1.5°C, -2.0°C
- (b) Compensated temperature is transmitted to the remote control and the compressor to control them.

Note (1) The detection temperature compensation is effective on the indoor unit temperature sensor only.

(27) High power operation (RC-EX3A only)

It operates at with the set temperature fixed at 16°C for cooling, 30°C for heating and maximum indoor fan speed for 15 minutes maximum.

(28) Energy-saving operation (RC-EX3A only)

It operates with the setting temperature fixed at 28°C for cooling, 22°C for heating or 25°C for auto. When fan control in cooling/heating thermo-OFF setting is “Set fan speed”, fan speed during thermo-OFF is changed to “Low”. (Maximum capacity is restricted at 80%.)

(29) Warm-up control (RC-EX3A only)

Operation will be started 5 to 60 minutes before use according to the forecast made by the microcomputer which calculates when the operation should be started in order to warm up the indoor temperature near the setting temperature at the setting time of operation start.

(30) Home leave mode (RC-EX3A only)

When the unit is not used for a long period of time, the room temperature is maintained at a moderate level, avoiding extremely hot or cool temperature.

- (a) Cooling or heating is operated according to the outdoor temperature (factory setting 35°C for cooling, 0°C for heating) and the setting temperature. (factory setting 33°C for cooling, 10°C for heating)
- (b) Setting temperature and indoor fan speed can be set by RC-EX3A.

(31) Auto temperature setting (RC-EX3A only)

Setting temperature is adjusted automatically at the adequate temperature the center setting temperature is 24°C by correcting the outdoor air temperature.

(32) Fan circulator operation (RC-EX3A only)

When the fan is used for circulation, the unit is operated as follows depending on the setting with the remote control.

- (a) If the invalid is selected with the remote control, the fan is operated continuously during the fan operation. (normal fan mode)
- (b) If the valid is selected with the remote control, the fan is operated or stopped when on the difference of the remote control temperature sensor and the return air temperature sensor becomes bigger than 3°C.

(33) The operation judgment is executed every 5 minutes (RC-EX3A only)

Setting temperature T_s is changed according to outdoor temperature.

This control is valid with cooling and heating mode. (Not auto mode)

- (a) Operate 5 minutes forcedly.
- (b) Setting temperature is adjusted every 10 minutes.
 - (i) Cooling mode.
 $T_s = \text{outdoor temperature} - \text{offset value}$
 - (ii) Heating mode.
 $T_s = \text{outdoor temperature} + \text{offset value}$
- (c) If the return air temperature lower than 18°C in cooling or return air temperature becomes higher than 25°C in heating, unit goes thermostat OFF.

(34) Auto fan speed control (RC-EX3A only)

In order to reach the room temperature to the set temperature as quickly as possible, the air flow rate is increased when the set temperature of thermostat differs largely from the return air temperature. According to temperature difference between set temperature and return air temperature, indoor fan tap are controlled automatically.

- Auto 1: Changes the indoor fan tap within the range of Hi ↔ Me ↔ Lo.
- Auto 2: Changes the indoor fan tap within the range of P-Hi ↔ Hi ↔ Me ↔ Lo.

(35) Indoor unit overload alarm (RC-EX3A only)

If the following condition is satisfied at 30 minutes after starting operation, RC-EX3A shows maintenance code "M07" and the signal is transmitted to the external output (CnT-2-5).

- Cooling, Dry, Auto(Cooling) : Indoor air temperature = Set room temperature by remote control + Alarm temperature difference
 - Heating, Auto(Heating) : Indoor air temperature = Set room temperature by remote control - Alarm temperature difference
- Alarm temperature difference is selectable between 5 to 10°C.

If the following condition is satisfied or unit is stopped, the signal is disappeared.

- Cooling, Dry, Auto(Cooling) : Indoor air temperature = Set room temperature + Alarm temperature difference - 2°C
- Heating, Auto(Heating) : Indoor air temperature = Set room temperature - Alarm temperature difference + 2°C

(36) Peak-cut timer (RC-EX3A only)

Power consumption can be reduced by restricting the maximum capacity.

Set the [Start time], the [End time] and the capacity limit % (Peak-cut %).

- 4-operation patterns per day can be set at maximum.
- The setting time can be changed by 5-minute interval.
- The selectable range of capacity limit % (Peak-cut %) is from 0% to 40-80% (20% interval).
- Holiday setting is available.

(37) Motion sensor control (RC-EX3A and RCN-E2 only)

The sensor determines the presence of people and the amount of activity, and the following controls are done by the motion sensor.

Following settings are necessary to activate motion sensor control.

- (a) Infrared (motion) sensor setting: Installation setting of remote control
The indoor unit which is set to “Enable” become valid.
- (b) Infrared (motion) sensor control: Energy-saving setting of remote control
The function which is set to “Enable” become valid.

RC-EX3A

TOP screen **Menu** ⇒ **Service setting** ⇒ **Installation settings** ⇒ **Service password**

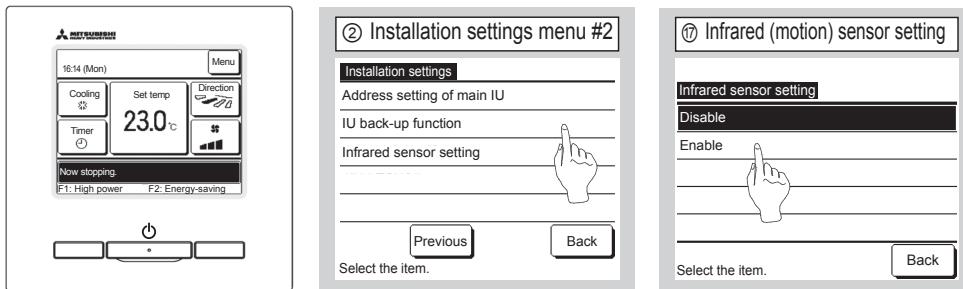

TOP screen **Menu** ⇒ **Energy-saving setting** ⇒ **Infrared sensor control** or **Motion sensor control**

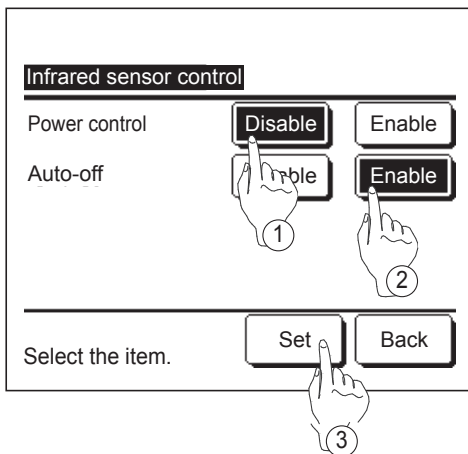

The Infrared sensor control screen and contents of the current settings are displayed.

- ① Enable/disable power control.
- ② Enable/disable auto-off.
- ③ After you set each item, tap the **Set** button.
The display returns to the Energy-saving setting menu screen.

RCN-E2

1. Set indoor functions

- ① Press the ON/OFF button to stop the unit.
- ② Press the desired one of the buttons shown item 2. while holding down the FUNCTION SETTING switch.
- ③ Use the selection buttons, ▲ and ▼, to change the setting.
- ④ Press the SET button.
The buzzer on the remote control signal receiver beeps twice, and the LED lamp flashes four times at two-second intervals.

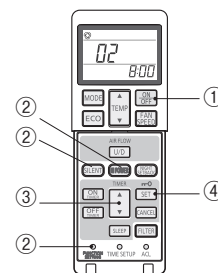

2. Setting details

| Button | Number indicator | Function setting |
|----------|------------------|--|
| SILENT | 00 | Infrared sensor setting (Motion sensor setting) : Disable |
| | 01 | Infrared sensor setting (Motion sensor setting) : Enable |
| HI POWER | 00 | Infrared sensor control (Motion sensor control) : Disable |
| | 01 | Infrared sensor control (Motion sensor control) : Power control only |
| | 02 | Infrared sensor control (Motion sensor control) : Auto OFF only |
| | 03 | Infrared sensor control (Motion sensor control) : Power control and Auto OFF |

(i) Power saving / comfort control

The set temperature is adjusted according to the presence of people and their amount of activity detected by the infrared (motion) sensor.

MODE:AUTO/COOL/HEAT mode operation

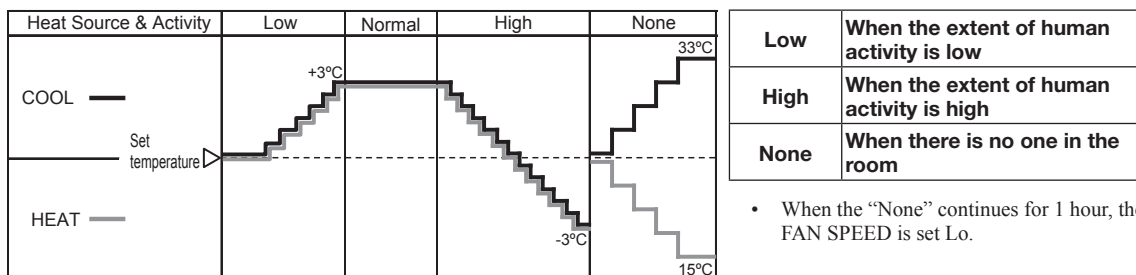

Notes (1) When the following operations are set, power saving control will be canceled.

- ① Energy-saving, Home leave mode, Warm-up control, Cooling operation check.
- ② When the operation mode is changed DRY or FAN.

(2) Not operable while the air-conditioner is OFF.

(ii) Auto-off control

When no activity is detected for 1 hour, unit will go stand-by mode.※ Unit will re-start operation automatically with the original set temperature by activity detection during the stand-by mode. When stand-by mode continues for 12 hours, unit stops.

※ Compressor keeps stopped regardless of the set temperature.

1.3 Outdoor units

1.3.1 Outline of heating operation

(1) Summary

(a) Capacity control

(i) Indoor unit SRK ** ZSX models only

| Model | SCM71ZS-W | SCM80ZS-W |
|----------|--------------|--------------|
| Capacity | 1.1 – 9.4 kW | 1.1 – 9.8 kW |

(ii) Indoor unit except SRK ** ZSX models

| Model | SCM71ZS-W | SCM80ZS-W |
|----------|--------------|--------------|
| Capacity | 1.1 – 9.1 kW | 1.1 – 9.6 kW |

Capacity control is within the range shown above. If demand capacity of the indoor units exceeds the maximum capacity of the outdoor unit, the demand capacity will be proportionally distributed.

(b) Outdoor compressor speed control

| Indoor compressor command total speed value | Decision speed |
|---|----------------|
| 0 rps | 0 rps |
| A rps or less | A rps |
| More than A rps, but B rps or less | A rps to B rps |
| More than B rps | B rps |

● Values of A, B

| Item | Model | SCM71ZS-W | SCM80ZS-W |
|------|-------|-----------|-----------|
| A | | 20 rps | |
| B | | 120 rps | |

(2) Operation of major functional components in heating mode

| Functional components | Operation | Heating | Thermostat OFF (All indoor units) | Thermostat OFF (Some of indoor units) | Fan, stop, abnormal stop (Some of indoor units) | Failure (Outdoor unit) |
|-----------------------|----------------------------|---|-----------------------------------|---|---|------------------------|
| | Command speed | Multi-operation rpm calculated based on the rpm required for each indoor unit | 0 (All indoor units) | 0 (Thermostat off units) | 0 (Fan, stop, abnormal stop units) | 0 (All units) |
| Indoor unit fan | Fixed | According to mode switching | Hot keep | According to mode switching | | Hot keep |
| | Automatic | According to command speed | Hot keep | According to command speed | | Hot keep |
| | Outdoor unit fan | According to outdoor unit speed | OFF | According to outdoor unit speed | | OFF |
| | Electronic expansion valve | According to decision speed | According to stop mode | According to heating stop unit control (Thermostat off units) | According to heating stop unit control (Fan, stop, abnormal stop units) | According to stop mode |
| | Compressor | ON | OFF | ON | ON | OFF |

(3) Defrost operation

(a) Starting conditions

Defrost operation can be started only when all of the following conditions are satisfied.

- (i) After start of heating operation
When it elapsed 40 minutes. (Accumulated compressor operation time)
- (ii) After finish of defrost operation
When it elapsed 40 minutes. (Accumulated compressor operation time)
- (iii) Outdoor heat exchanger temperature (Tho-R1)
When the temperature has been -2°C or less for 3 minutes continuously.
- (iv) The difference between the outdoor air sensor temperature (Tho-A) and outdoor heat exchanger sensor temperature (Tho-R1) is as following.

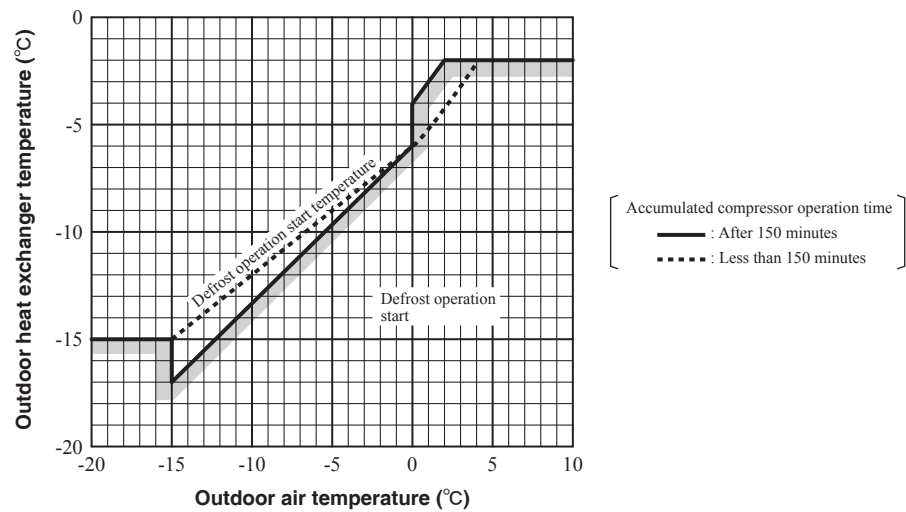

- (v) During continuous compressor operation
In case satisfied all of following conditions.
 - Connect compressor speed 0 rps 10 times or more.
 - Satisfy i), ii) and iii) conditions above.
 - Outdoor air temperature is 3°C or less.

(b) Ending conditions

Operation returns to the heating cycle when either one of the following conditions is satisfied.

- (i) Outdoor heat exchanger sensor (Tho-R1) temperature: 13°C or higher
- (ii) Continued operation time of defrost → For more than 10 minutes

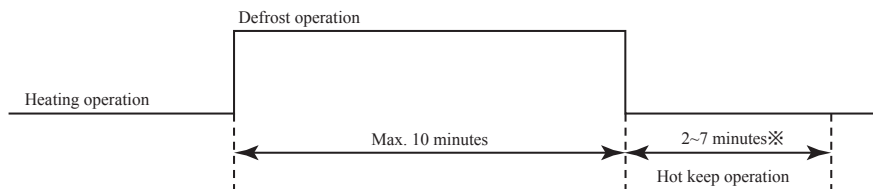

※ Depends on an operation condition, the time can be longer than 7 minutes.

1.3.2 Outline of cooling operation

(1) Summary

(a) Capacity control

(i) Indoor unit SRK ** ZSX models only

| Model | SCM71ZS-W | SCM80ZS-W |
|----------|--------------|--------------|
| Capacity | 1.8 – 8.8 kW | 1.8 – 9.2 kW |

(ii) Indoor unit except SRK ** ZSX models

| Model | SCM71ZS-W | SCM80ZS-W |
|----------|--------------|--------------|
| Capacity | 1.8 – 8.3 kW | 1.8 – 8.7 kW |

Capacity control is within the range shown above. If demand capacity of the indoor units exceeds the maximum capacity of the outdoor unit, the demand capacity will be proportionally distributed.

(b) Outdoor compressor speed control

| Indoor compressor command total speed value | Decision speed |
|---|----------------|
| 0 rps | 0 rps |
| A rps or less | A rps |
| More than A rps, but B rps or less | A rps to B rps |
| More than B rps | B rps |

● Values of A, B

| Item | Model | SCM71ZS-W | SCM80ZS-W |
|------|-------|-----------|-----------|
| A | | 20 rps | |
| B | | 120 rps | |

(2) Operation of major functional components in cooling mode

| Functional components | | Operation | Cooling | Thermostat OFF (All indoor units) | Thermostat OFF (Some of indoor units) | Fan, stop, abnormal stop (Some of indoor units) | Failure (Outdoor unit) |
|----------------------------|-----------|---------------------------------|---|-----------------------------------|---|---|------------------------|
| Command speed | | | Multi-operation rpm calculated based on the rpm required for each indoor unit | 0 (All indoor units) | 0 (Thermostat off units) | 0 (Fan, stop, abnormal stop units) | 0 (All units) |
| Indoor unit fan | Fixed | According to mode switching | | | | | |
| | Automatic | According to command speed | According to mode switching | According to command speed | | | |
| Outdoor unit fan | | According to outdoor unit speed | OFF | According to outdoor unit speed | | | OFF |
| Electronic expansion valve | | According to decision speed | According to stop mode | All closed (Thermostat off units) | All closed (Fan, stop, abnormal stop units) | According to stop mode | |
| Compressor | | ON | OFF | ON | ON | OFF | |

1.3.3 Protective control function

(1) Cooling overload protective control

(a) Operating conditions

When the outdoor air temperature (Tho-A) has become continuously for 30 seconds at 41°C or more, or 47°C or more with the compressor running, the lower limit speed of compressor is brought up.

| | | |
|--------------------------------|--------------------|--------------------|
| Outdoor air temperature | 41°C or more (ON1) | 47°C or more (ON2) |
| Lower limit speed | 30 rps | 30 rps |

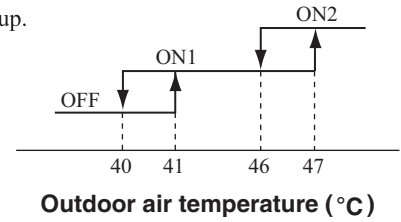

(b) Detail of operation

The lower limit of compressor speed is set to 30 or 40 rps and even if the calculated result becomes lower than that after fuzzy calculation, the speed is kept to 30 or 40 rps. However, when the thermostat OFF, the speed is reduced to 0 rps.

(c) Reset conditions

When either of the following conditions is satisfied.

- (i) The outdoor air temperature is lower than 40°C.
- (ii) The compressor speed is 0 rps.

(2) Cooling high pressure control

(a) Purpose

Prevents anomalous high pressure operation during cooling.

(b) Detector

Outdoor heat exchanger sensor (Tho-R2).

(c) Detail of operation

(Example) Fuzzy

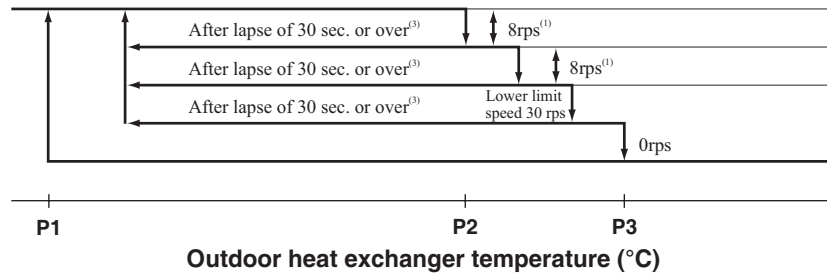

| | Tho-R2 (°C) | | |
|----------------|-------------|------|----|
| | P1 | P2 | P3 |
| Range A | 52 | 55 | 58 |
| Range B | 48 | 51 | 54 |
| Range C | 58 | 59.5 | 61 |

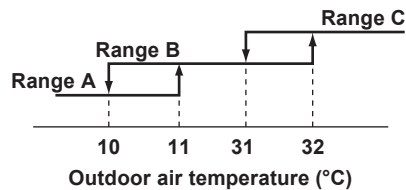

- Notes
- (1) When the outdoor heat exchanger temperature is in the range of P2-P3°C, the speed is reduced by 8 rps at each 30 seconds.
 - (2) When the temperature is P3°C or higher, the compressor is stopped.
 - (3) When the outdoor heat exchanger temperature is in the range of P1-P2°C, if the compressor speed is been maintained and the operation has continued for more than 30 seconds at the same speed, it returns to the normal cooling operation.

(3) Cooling low outdoor temperature protective control

(a) Operating conditions

When the outdoor air temperature (Tho-A) is 22°C or lower continues for 20 seconds while compressor command speed is other than 0 rps.

(b) Detail of operation

- (i) The lower limit of compressor command speed is set to B or D rps and even if the speed becomes lower than B or D rps, the speed is kept to B or D rps. However, when the thermostat becomes OFF, the speed is reduced to 0 rps.
- (ii) The upper limit of compressor command speed is set to A or C rps, the speed is kept to A or C rps.

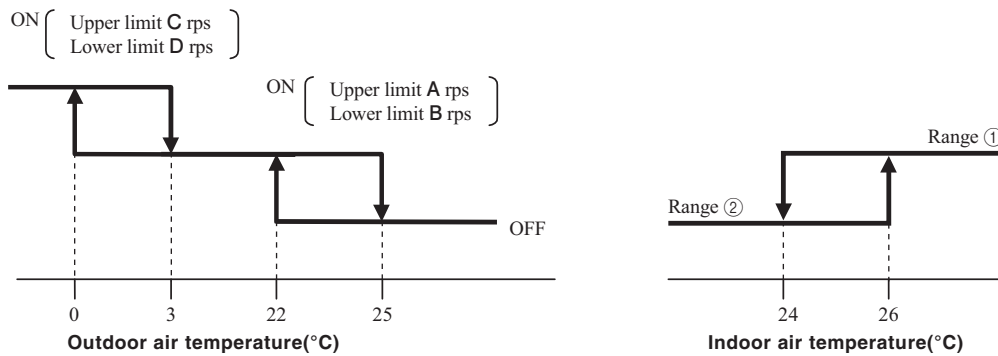

● Values of A - D Unit: rps

| Item | A | B | | C | D |
|------------------|----|---------|----|----|----|
| | | ① | ② | | |
| Compressor speed | 75 | Release | 30 | 60 | 40 |

(c) Reset conditions

When the either of the following conditions is satisfied

- (i) When the outdoor air temperature (Tho-A) becomes 25°C or higher.
- (ii) When the compressor command speed is 0rps.

(4) Heating high pressure control

(a) Starting condition

When the indoor heat exchanger temperature (Th2 (Thi-R1)) has risen to a specified temperature while the compressor is turned on.

(b) Operating condition

Compressor command speed is controlled according to the zones of indoor heat exchanger temperature as shown by the following table.

| | Th2 < P1 | P1 ≤ Th2 < P2 | P2 ≤ Th2 < P3 | P3 ≤ Th2 < P4 | P4 ≤ Th2 |
|-----------------------|----------|---------------|---------------|---------------|----------|
| Compressor speed (NP) | Normal | Retention | NP-4rps | NP-8rps | N=0 |
| Sampling time (s) | — | 20 | 20 | 20 | — |

Unit: °C

| NP | Th2 | P1 | P2 | P3 | P4 |
|---------------|-----|---------|---------|---------|---------|
| 10 ≤ NP < 30 | | 41 | 47 | 52 | 55 |
| 30 ≤ NP < 31 | | 41 - 45 | 47 - 52 | 52 - 57 | 55 - 61 |
| 31 ≤ NP < 90 | | 45 | 52 | 57 | 61 |
| 90 ≤ NP < 120 | | 45 - 43 | 52 - 45 | 57 - 48 | 61 - 50 |
| 120 ≤ NP | | 43 | 45 | 48 | 50 |

(5) Heating overload protective control

(a) Operating conditions

When the outdoor air temperature (Tho-A) is 10°C or higher continues for 30 seconds while the compressor speed other than 0 rps.

(b) Detail of operation

- (i) Taking the upper limit of compressor speed range at **A** or **C**, if the output speed obtained with the fuzzy calculation exceeds the upper limit, the upper limit value is maintained.
- (ii) The lower limit of compressor speed is set to **B** or **D** and even if the calculated result becomes lower than that after fuzzy calculation, the speed is kept to **B** or **D**. However, when the thermostat OFF, the speed is reduced to 0 rps.
- (iii) Inching prevention control is activated and inching prevention control is carried out with the minimum speed set at **B** or **D**.

(c) Reset conditions

The outdoor air temperature (Tho-A) is lower than 8°C.

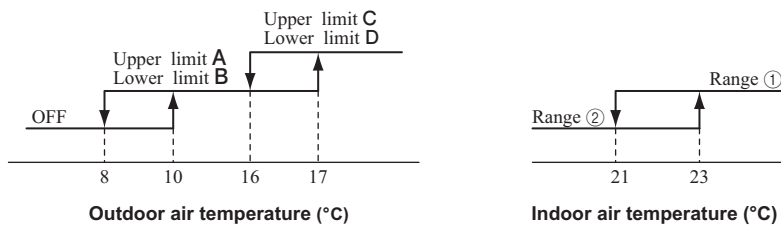

Unit: rps

| Item | A | B | | C | D |
|------------------|----|----|---------|----|----|
| | | ① | ② | | |
| Compressor speed | 90 | 30 | Release | 75 | 30 |

(6) Heating low outdoor temperature protective control

(a) Operating conditions

When the outdoor air temperature (Tho-A) is -2°C or lower continues for 30 seconds while the compressor speed is other than 0 rps.

(b) Detail of operation

The lower limit compressor speed is change as shown in the figure below.

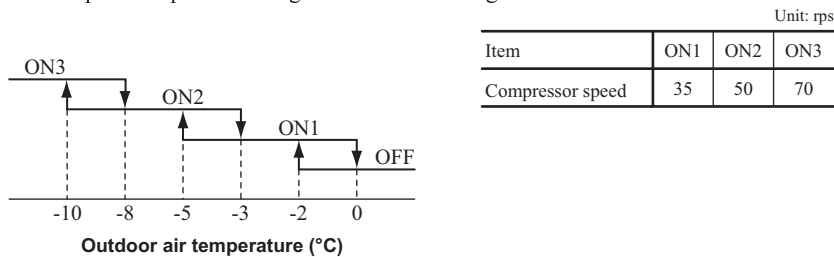

(c) Reset conditions

When either of the following conditions is satisfied.

- (i) The outdoor air temperature (Tho-A) becomes 0°C.
- (ii) The compressor speed is 0 rps.

(7) Refrigeration cycle system protective control**(a) Starting condition**

This control starts when the following conditions are satisfied.

- (i) When it has elapsed 30 minutes after the compressor was changed from OFF to ON in the cooling operation mode for more than 5 minutes.
- (ii) When the compressor command speed has satisfied the following conditions.
- (iii) When the indoor air temperature of running indoor unit (Th1 (Thi-A)) and the indoor heat exchanger temperature (Th2 (Thi-R1)) have satisfied the following condition even on one unit.
- (iv) Except following mode
 - Silent mode

| Unit | Compressor command speed | Indoor air temperature (Th1 °C) | Indoor air temperature (Th1) and indoor heat exchanger temperature (Th2) | Duration |
|------|--------------------------|---------------------------------|--|----------|
| 1 | 40 rps | $10 \leq Th1 \leq 40$ | $Th1 - 4 < Th2$ | 5 minute |
| 2 | 50 rps | | $Th1 - 3 < Th2$ | |
| 3 | 60 rps | | $Th1 - 2 < Th2$ | |
| 4 | 70 rps | | $Th1 - 1 < Th2$ | |

(b) Contents of control

- (i) Stop the compressor and delay the start, and then restarts.
- (ii) Compressor stops by the abnormal stop when the compressor stop has occurred 3 times in one hour.

(8) Service valve (gas side) closing operation**(a) Starting conditions**

- (i) Operation mode : Heating
- (ii) Compressor conditions : OFF → ON

(b) Contents control

If the output current of inverter exceeds the specifications, it makes the compressor stopping.

(c) Anomalous stop control

If the inverter output current value exceeds the setting value within 80 seconds the compressor stops.

(9) Compressor overheat protection

(a) Purpose

It is designed to prevent deterioration of oil, burnout of motor coil and other trouble resulting from the compressor overheat.

(b) Detail of operation

(i) Speeds are controlled with temperature detected by the sensor (Tho-D) mounted on the discharge pipe.

(Example) Fuzzy

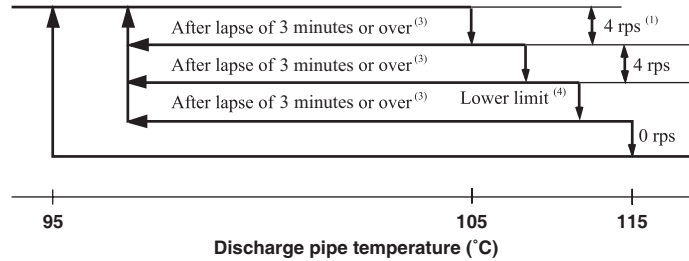

- Notes (1) When the discharge pipe temperature is in the range of 105–115°C, the speed is reduced by 4 rps.
 (2) When the discharge pipe temperature is raised and continues operation for 20 seconds without changing, then the speed is reduced again by 4 rps.
 (3) If the discharge pipe temperature is in the range of 95–105°C even when the compressor command speed is maintained for 3 minutes when the temperature is in the range of 95–105°C, the speed is raised by 1 rps and kept at that speed for 3 minutes. This process is repeated until the command speed is reached.
 (4) Lower limit speed

| | Cooling | Heating |
|--------------------------|---------|---------|
| Lower limit speed | 20 rps | 20 rps |

(ii) If the temperature of 115°C is detected by the sensor on the discharge pipe, then the compressor will stop immediately. When the discharge pipe temperature drops and the time delay of 3 minutes is over, the unit starts again within 1 hour but there is no start at the third time.

(10) Current safe

(a) Purpose

Current is controlled not to exceed the upper limit of the setting operation current.

(b) Detail of operation

Input current to the converter is monitored with the current sensor fixed on the printed circuit board of the outdoor unit and, if the operation current value reaches the limiting current value, the compressor command speed is reduced.

If the mechanism is actuated when the compressor command speed is less than 30 rps, the compressor is stopped immediately. Operation starts again after a delay time of 3 minutes.

(c) Current safe control value

Set this using the jumper wire (J1 or J2) on the outdoor unit PCB. Control starts when it exceeds the control value.

(i) Switching with jumper wire

| | | Jumper wire (J2) | |
|------------------|--|--|----------------|
| | | Short-circuit (At shipping from factory) | Short-circuit |
| Jumper wire (J1) | Short-circuit (At shipping from factory) | Current safe ① | Current safe ② |
| | Open | Current safe ③ | Current safe ③ |

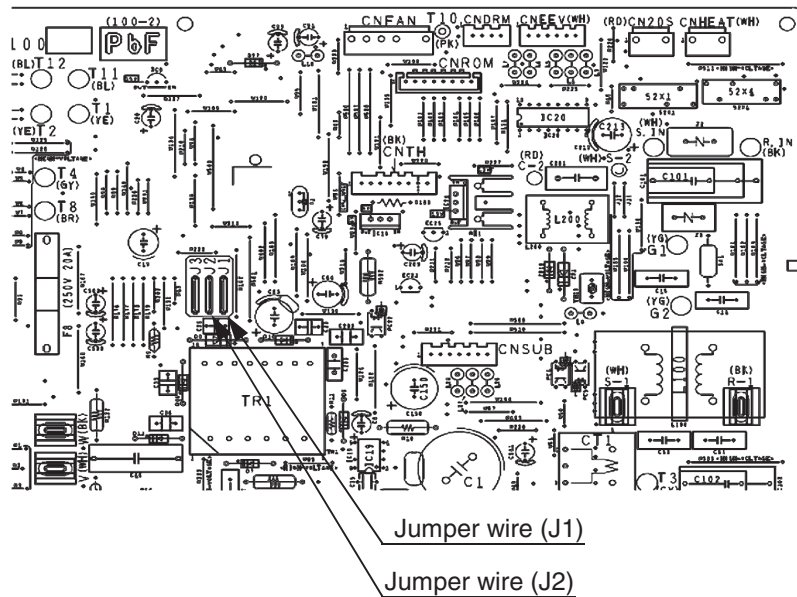

(ii) Control value

Unit: A

| Current safe ① | | Current safe ② | | Current safe ③ | |
|----------------|---------|----------------|---------|----------------|---------|
| Cooling | Heating | Cooling | Heating | Cooling | Heating |
| 13.0 | 16.0 | 10.0 | 10.0 | 7.5 | 7.5 |

(11) Current cut

(a) Purpose

Inverter is protected from overcurrent.

(b) Detail of operation

Output current from the inverter is monitored with a shunt resistor and, if the current exceeds the setting value, the compressor is stopped immediately. Operation starts again after a delay time of 3 minutes.

(12) Outdoor unit failure

This is a function for determining when there is trouble with the outdoor unit during air-conditioning.

The compressor is stopped if any one of the following in item (a), (b) is satisfied. Once the unit is stopped by this function, it is not restarted.

(a) When the input current is measured at 1 A or less for 3 continuous minutes or more.

(b) If the compressor command sends a 0 rps signal to the indoor unit 3 times or more within 20 minutes of the power being turned on.

(13) Discharge pipe sensor disconnection protection control

(a) When the compressor command speed is other than 0 rps.

(i) Tho-D(10)–Tho-D(0) < 8 °C, and Tho-D(10)–Tho-A(10) < 5 °C

The compressor command speed is set on A rps for 5 minutes. After 5 minutes, the compressor command speed is set on B rps for 5 minutes.

(ii) Tho-D(20)–Tho-D(15) < 5 °C

The compressor command speed is set on 0 rps.

Notes (1) Tho-D(X): After compressor operation, the discharge pipe temperature sensor after X minutes.

(2) Tho-A(X): After compressor operation, the outdoor air temperature sensor after X minutes.

- (b) Once the unit is stopped by this function, it is not restarted.

• Values of A, B

| Model | SCM71ZS-W | SCM80ZS-W |
|----------|-----------|-----------|
| A | 20 rps | 20 rps |
| B | 60 rps | 60 rps |

Note (1) When the jumper wire (J32) on the outdoor unit sub-PCB is short-circuited (factory default), this control is performed only at initial operation after turning the power source on. If the jumper wire (J32) is open, this control is not performed.

(14) Regulation of outdoor air flow

- (a) The fan operates as follows according to the compressor command speed. (Except during defrost operation.)

| Compressor speed (rps) | Cooling | | | | Heating | | | |
|--------------------------|--------------|-----------------------------|-----------------------------|------------|--------------|-----------------------------|-----------------------------|------------|
| | Less than 31 | More than 31 but 46 or less | More than 46 but 56 or less | 56 or more | Less than 31 | More than 31 but 66 or less | More than 66 but 78 or less | 78 or more |
| Outdoor fan speed | 3rd speed | 4th speed | 5th speed | 6th speed | 3rd speed | 4th speed | 5th speed | 6th speed |

- (b) If the outdoor unit's fan speed drops, the outdoor fan is run for 1 minute at that speed.

(15) Serial signal transmission error protection

(a) Purpose

Prevents malfunction resulting from error on the indoor ↔ outdoor signals.

(b) Detail of operation

- (i) If the compressor is operating and a serial signal cannot be received from the indoor control with outdoor control having serial signals continues for 7 minutes and 35 seconds, the compressor is stopped.
- (ii) After the compressor has been stopped, it will be restarted after the compressor start delay if a serial signal can be received again from the indoor control.

(16) Rotor lock

If the motor for the compressor does not turn after it has been started, it is determined that a compressor lock has occurred and the compressor is stopped.

(17) Outdoor fan motor protection

If the outdoor fan motor has operated at 75 min⁻¹ or under for more than 30 seconds, the compressor and fan motor are stopped.

(18) Outdoor fan control at low outdoor temperature

(a) Cooling

(i) Operating conditions

When the outdoor air temperature (Tho-A) is 22°C or lower continues for 30 seconds while the compressor command speed is other than 0 rps.

(ii) Detail of operation

After the outdoor fan operates at A speed for 60 seconds; the corresponding outdoor heat exchanger temperature shall implement the following controls.

● Value of A

| | Outdoor fan |
|--|-------------|
| Outdoor air temperature > 10°C | 2nd speed |
| Outdoor air temperature ≤ 10°C | 1st speed |

- 1) Outdoor heat exchanger temperature (Tho-R2) ≤ 34°C

After the outdoor fan speed drops (down) to 1 speed for 60 seconds; if the outdoor heat exchanger temperature is lower than 34°C, gradually reduce the outdoor fan speed by 1 speed.

● Lower limit speed

| | Lower limit speed |
|--|-------------------|
| Outdoor air temperature > 16°C | 2nd speed |
| Outdoor air temperature ≤ 16°C | 1st speed |

- 2) $34^{\circ}\text{C} < \text{Outdoor heat exchanger temperature (Tho-R2)} \leq 45^{\circ}\text{C}$
After the outdoor fan speed maintains at A speed for 20 seconds; if the outdoor heat exchanger temperature is 34°C - 45°C , maintain outdoor fan speed.
- 3) Outdoor heat exchanger temperature $(\text{Tho-R2}) > 45^{\circ}\text{C}$
After the outdoor fan speed rises (up) to 1 speed for 60 seconds; if the outdoor heat exchanger temperature is higher than 45°C , gradually increase outdoor fan speed by 1 speed. (Upper limit 3rd speed)

(iii) Reset conditions

When either of the following conditions is satisfied

- 1) The outdoor air temperature (Tho-A) is 24°C or higher.
- 2) The compressor command speed is 0 rps.

(b) Heating

(i) Operating conditions

When the outdoor air temperature (Tho-A) is 3°C or lower continues for 30 seconds while the compressor command speed is other than 0 rps.

(ii) Detail of operation

The outdoor fan is stepped up by 1 speed. [Upper limit 7th speed]

(iii) Reset conditions

When either of the following conditions is satisfied

- 1) The outdoor air temperature (Tho-A) is 5°C or higher.
- 2) The compressor command speed is 0 rps.

(19) Outdoor fan control at overload

(a) Cooling

(i) Starting condition

When the outdoor air temperature (Tho-A) has risen higher than 41°C for 30 seconds continuously while the compressor is operating.

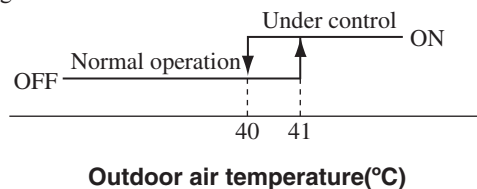

(ii) Contents of control

The outdoor unit fan is stepped up by 3 speed. [Upper limit 7th speed]

(iii) Reset condition

When the compressor is turned off or the outdoor air temperature (Tho-A) has dropped lower than 40°C .

(b) Heating

(i) Start condition

When the outdoor heat exchanger temperature (Tho-R1) has risen higher than 13°C for 30 seconds continuously while the compressor is operating.

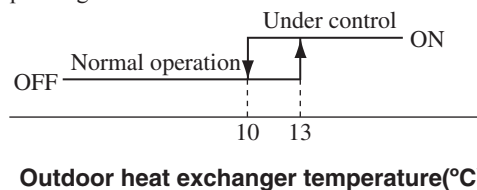

(ii) Contents of control

The outdoor unit fan is stepped down by 3 speed. (Lower limit is 2nd speed)

(iii) Reset condition

When the compressor is turned off or the outdoor heat exchanger temperature (Tho-R1) has dropped lower than 10°C .

(20) Limit of the number of compressor starts

Maximum number of compressor starts is limited to 6 times per hour by cutting jumper wire (JA31) on the outdoor unit sub PCB.

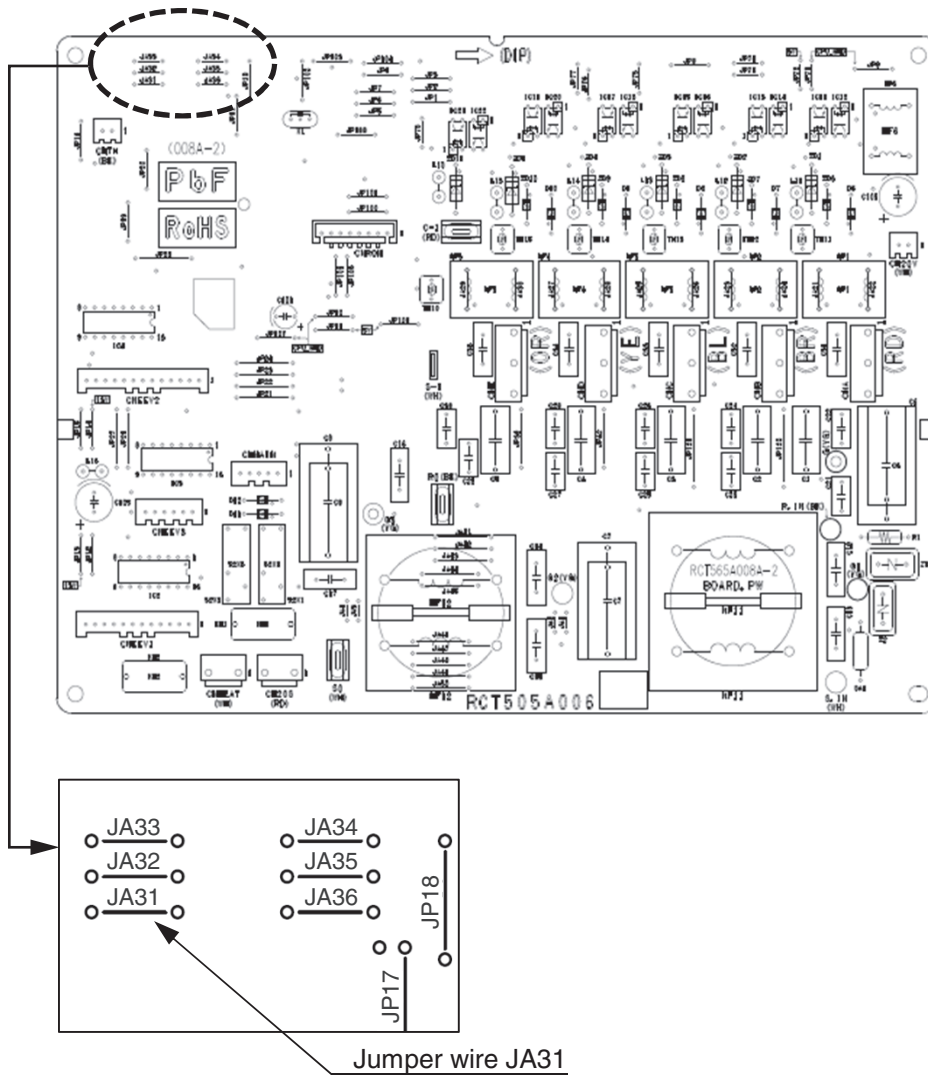

2. MAINTENANCE DATA

2.1 SRK and SRR series

(1) Cautions

- (a) If you are disassembling and checking an air-conditioner, be sure to turn off the power before beginning. When working on indoor units, let the unit sit for about 1 minute after turning off the power before you begin work. When working on an outdoor unit, there may be an electrical charge applied to the main circuit (electrolytic condenser), so begin work only after discharging this electrical charge (to DC10V or lower).
- (b) When taking out printed circuit boards, be sure to do so without exerting force on the circuit boards or package components.
- (c) When disconnecting and connecting connectors, take hold of the connector housing and do not pull on the lead wires.

(2) Items to check before troubleshooting

- (a) Have you thoroughly investigated the details of the trouble which the customer is complaining about?
- (b) Is the air-conditioner running? Is it displaying any self-diagnosis information?
- (c) Is a power source with the correct voltage connected?
- (d) Are the control lines connecting the indoor and outdoor units wired correctly and connected securely?
- (e) Is the outdoor unit's service valve open?

(3) Troubleshooting procedure (If the air-conditioner does not run at all)

If the air-conditioner does not run at all, diagnose the trouble using the following troubleshooting procedure. If the air-conditioner is running but breaks down, proceed to troubleshooting step (4).

Important When all the following conditions are satisfied, we say that the air-conditioner will not run at all.

- (a) The RUN light does not light up.
- (b) The flaps do not open.
- (c) The indoor unit fan motors do not run.
- (d) The self-diagnosis display does not function.

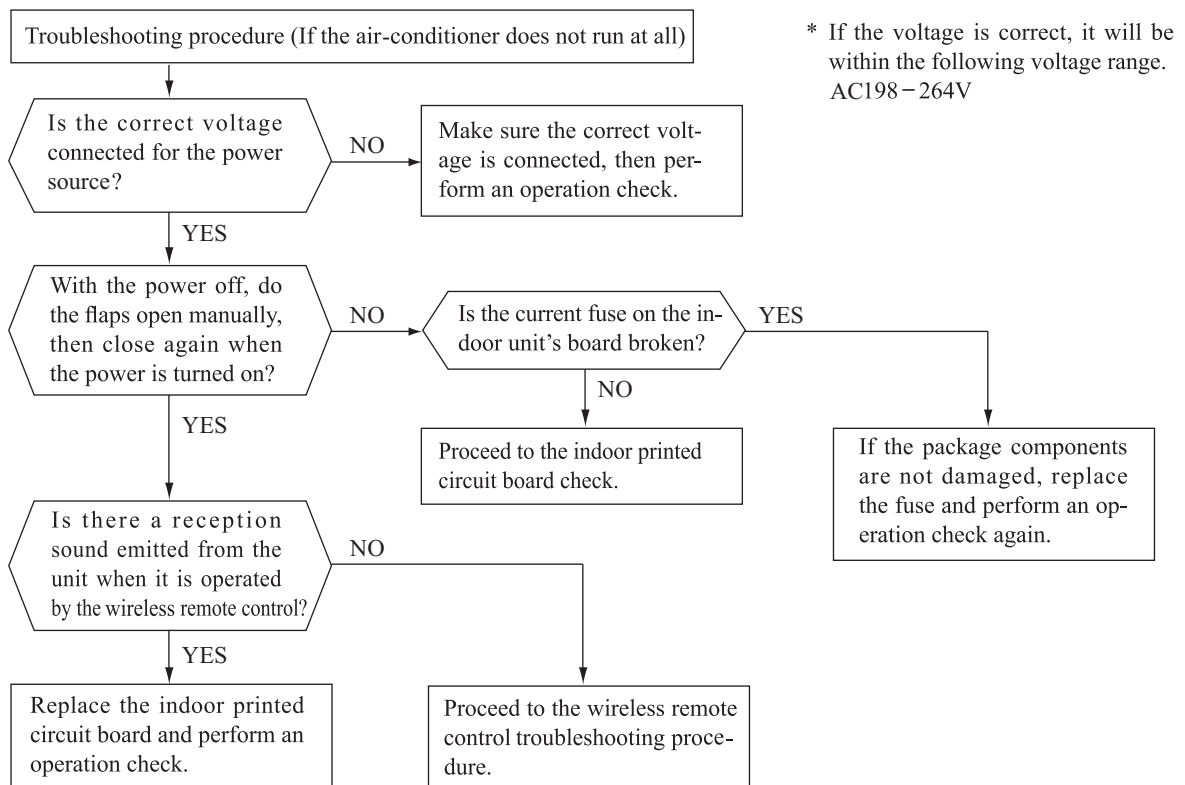

(4) Troubleshooting procedure (If the air-conditioner runs)

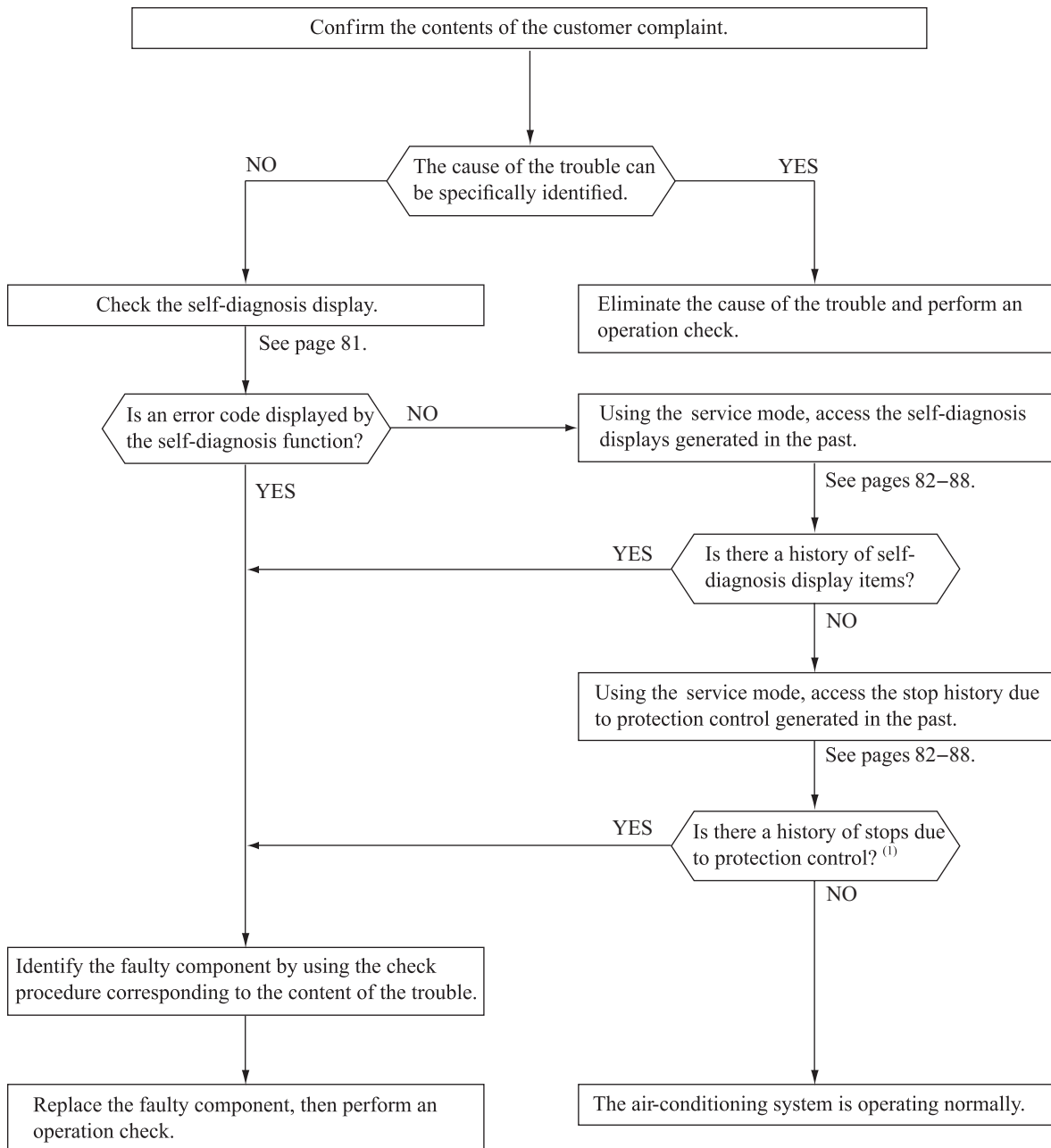

Note (1) Even in cases where only intermittent stop data are generated, the air-conditioning system is normal. However, if the same protective operation recurs repeatedly (3 or more times), it will lead to customer complaints. Judge the conditions in comparison with the contents of the complaints.

(5) Self-diagnosis table

When this air-conditioner performs an emergency stop, the reason why the emergency stop occurred is displayed by the flashing of display lights. If the air-conditioner is operated using the remote control 3 minutes or more after the emergency stop, the trouble display stops and the air-conditioner resumes operation. ⁽¹⁾

Models SCM71, 80

| Indoor unit display panel | | Outdoor main PCB Red LED | Wired remote control display ⁽²⁾ | Description of trouble | Cause | Display (flashing) condition |
|---------------------------|----------------|--------------------------|---|---|---|---|
| RUN light | TIMER light | | | | | |
| 1-time flash | ON | Stays OFF | — | Heat exchanger temperature sensor 1 error | <ul style="list-style-type: none"> Broken heat exchanger temperature sensor 1 wire, poor connector connection Indoor unit PCB is faulty | When a heat exchanger temperature sensor 1 wire disconnection is detected while operation is stopped. (If a temperature of -28°C or lower is detected for 15 seconds, it is judged that the wire is disconnected.) (Not displayed during operation.) |
| 2-time flash | ON | Stays OFF | — | Room temperature sensor error | <ul style="list-style-type: none"> Broken room temperature sensor wire, poor connector connection Indoor unit PCB is faulty | When a room temperature sensor wire disconnection is detected while operation is stopped. (If a temperature of -45°C or lower is detected for 15 seconds, it is judged that the wire is disconnected.) (Not displayed during operation.) |
| 3-time flash | ON | Stays OFF | — | Heat exchanger temperature sensor 2 error | <ul style="list-style-type: none"> Broken heat exchanger temperature sensor 2 wire, poor connector connection Indoor unit PCB is faulty | When a heat exchanger temperature sensor 2 wire disconnection is detected while operation is stopped. (If a temperature of -28°C or lower is detected for 15 seconds, it is judged that the wire is disconnected.) (Not displayed during operation.) |
| 4-time flash | ON | Stays OFF | E 9 | Drain ⁽³⁾ trouble | <ul style="list-style-type: none"> Defective drain pump (DM), broken drain pump wire Anomalous float switch operation Defective indoor unit PCB faulty | If the float switch OPEN is defected for 3 seconds continuously or if float switch connector or wire is disconnected. |
| 6-time flash | ON | Stays OFF | E 16 | Indoor fan motor error | <ul style="list-style-type: none"> Defective fan motor, poor connector connection | When conditions for turning the indoor unit's fan motor on exist during air-conditioner operation, an indoor unit fan motor speed of 300 min ⁻¹ or lower is measured for 30 seconds or longer. (The air conditioner stops.) |
| Keeps flashing | 1-time flash | 8-time flash | E 38 | Outdoor air temperature sensor error | <ul style="list-style-type: none"> Broken outdoor air temperature sensor wire, poor connector connection Outdoor unit main PCB is faulty | -55°C or lower is detected for 5 seconds continuously 3 times within 40 minutes after initial detection of this anomalous temperature. Or -55°C or higher is detected for within 20 seconds after power ON. (The compressor is stopped.) |
| Keeps flashing | 2-time flash | 8-time flash | E 37 | Outdoor heat exchanger temperature sensor error | <ul style="list-style-type: none"> Broken heat exchanger temperature sensor wire, poor connector connection Outdoor unit main PCB is faulty | -55°C or lower is detected for 5 seconds continuously 3 times within 40 minutes after initial detection of this anomalous temperature. Or -55°C or higher is detected for within 20 seconds after power ON. (The compressor is stopped.) |
| Keeps flashing | 4-time flash | 8-time flash | E 39 | Discharge pipe temperature sensor error | <ul style="list-style-type: none"> Broken discharge pipe temperature sensor wire, poor connector connection Outdoor unit main PCB is faulty | -25°C or lower is detected for 5 seconds continuously 3 times within 40 minutes after initial detection of this anomalous temperature. (The compressor is stopped.) |
| Keeps flashing | 5-time flash | 8-time flash | E 53 | Outdoor suction pipe temperature sensor error | <ul style="list-style-type: none"> Broken suction pipe temperature sensor wire, poor connector connection Outdoor unit sub PCB is faulty | -55°C or lower is detected for 5 seconds continuously 3 times within 40 minutes after initial detection of this anomalous temperature. Or -55°C or higher is detected for within 20 seconds after power ON. (The compressor is stopped.) |
| ON | 1-time flash | 1-time flash | E 42 | Current cut | <ul style="list-style-type: none"> Compressor locking, open phase on compressor output, short circuit on power transistor, service valve is closed | The compressor output current exceeds the set value during compressor start. (The air-conditioner stops.) |
| ON | 2-time flash | 2-time flash | E 59 | Trouble of outdoor unit | <ul style="list-style-type: none"> Broken compressor wire Compressor blockage | When there is an emergency stop caused by trouble in the outdoor unit, or the input current value is found to be lower than the set value. (The air-conditioner stops.) |
| ON | 3-time flash | 3-time flash | E 58 | Current safe stop | <ul style="list-style-type: none"> Overload operation Overcharge Compressor locking | When the compressor command speed is lower than the set value and the current safe has operated. (the compressor stops) |
| ON | 4-time flash | 1-time flash | E 51 | Power transistor error | <ul style="list-style-type: none"> Broken power transistor | When the power transistor is judged breakdown while compressor starts. (The compressor is stopped.) |
| ON | 5-time flash | 5-time flash | E 36 | Over heat of compressor | <ul style="list-style-type: none"> Gas shortage, defective discharge pipe temperature sensor, service valve is closed | When the value of the discharge pipe temperature sensor exceeds the set value. (The air-conditioner stops.) |
| ON | 6-time flash | 6-time flash | E 5 | Error of signal transmission | <ul style="list-style-type: none"> Defective power source, Broken signal wire, defective indoor/outdoor unit sub PCB | When there is no signal between the indoor unit PCB and outdoor unit PCB for 10 seconds or longer (when the power is turned on), or when there is no signal for 7 minute 35 seconds or longer (during operation) (the compressor is stopped). |
| ON | 7-time flash | ON | E 48 | Outdoor fan motor error | <ul style="list-style-type: none"> Defective fan motor, poor connector connection | When the outdoor unit's fan motor speed continues for 30 seconds or longer at 75 min ⁻¹ or lower. (3 times) (The air-conditioner stops.) |
| ON | Keeps flashing | 2-time flash | E 35 | Cooling high pressure protection | <ul style="list-style-type: none"> Overload operation, overcharge Broken outdoor heat exchange temperature sensor wire Service valve is closed | When the value of the outdoor heat exchanger temperature sensor exceeds the set value. |
| 2-time flash | 2-time flash | 7-time flash | E 60 | Rotor lock | <ul style="list-style-type: none"> Defective compressor Open phase on compressor Defective outdoor unit PCB | If the compressor motor's magnetic pole positions cannot be correctly detected when the compressor starts. (The air-conditioner stops.) |
| 5-time flash | ON | 2-time flash | E 47 | Active filter voltage error | <ul style="list-style-type: none"> Defective active filter | When the wrong voltage connected for the power source. When the outdoor unit main PCB is faulty |
| 7-time flash | ON | 2-time flash | E 57 | Refrigeration cycle system protective control | <ul style="list-style-type: none"> Service valve is closed. Refrigerant is insufficient | When refrigeration cycle system protective control operates. |
| — | — | 4-time flash | E 45 | Outdoor unit sub PCB communication error | <ul style="list-style-type: none"> Outdoor unit sub PCB faulty Poor connection of wire between outdoor unit sub PCB – main PCB | Communication error for 15 minutes: Detected more than 15 seconds 4 times |
| — | — | Stays OFF | E 1 | Error of wired remote control wiring | <ul style="list-style-type: none"> Broken wired remote control wire, defective indoor unit PCB | The wired remote control wire Y is open. The wired remote control wires X and Y are reversely connected. Noise is penetrating the wired remote control lines. The wired remote control or indoor PCB is faulty. (The communications circuit is faulty.) |
| Stays OFF | Keeps flashing | — | — | Limit switch error | <ul style="list-style-type: none"> Defective limit switch Defective suction panel set Defective indoor unit control PCB | Actuation of limit switch |

Notes (1)The air-conditioner cannot be restarted using the remote control for 3 minutes after operation stops.

(2)The wired remote control is option parts.

(3)SR series only.

(6) Service mode (Trouble mode access function)

This air-conditioner is capable of recording error displays and protective stops (service data) which have occurred in the past. If self-diagnosis displays cannot be confirmed, it is possible to get a grasp of the conditions at the time trouble occurred by checking these service data.

(a) Explanation of terms

| Term | Explanation |
|----------------------------|--|
| Service mode | The service mode is the mode where service data are displayed by flashing of the display lights when the operations in item (b) below are performed with the indoor control. |
| Service data | These are the contents of error displays and protective stops which occurred in the past in the air-conditioner system. Error display contents and protective stop data from past anomalous operations of the air-conditioner system are saved in the indoor unit control's non-volatile memory (memory which is not erased when the power goes off). There are two types of data, self-diagnosis data and stop data, described below. |
| Self-diagnosis data | These are the data which display the reason why a stop occurred when an error display(self-diagnosis display) occurred in an indoor unit. Data are recorded for up to 5 previous occurrences. Data which are older than the 5th previous occurrence are erased. In addition, data on the temperature of each sensor (room temperature, indoor heat exchanger, outdoor heat exchanger, outdoor air temperature, discharge pipe), remote control information (operation switching, fan speed switching) are recorded when trouble occurs, so more detailed information can be checked. |
| Stop data | These are the data which display the reason by a stop occurred when the air-conditioning system performed protective stops, etc. in the past. Even if stop data alone are generated, the system restarts automatically. (After executing the stop mode while the display is normal, the system restarts automatically.) Data for up to 10 previous occasions are stored. Data older than the 10th previous occasion are erased. (Important) In cases where transient stop data only are generated, the air-conditioner system may still be normal. However, if the same protective stop occurs frequently (3 or more times), it could lead to customer complaints. |

(b) Service mode display procedure

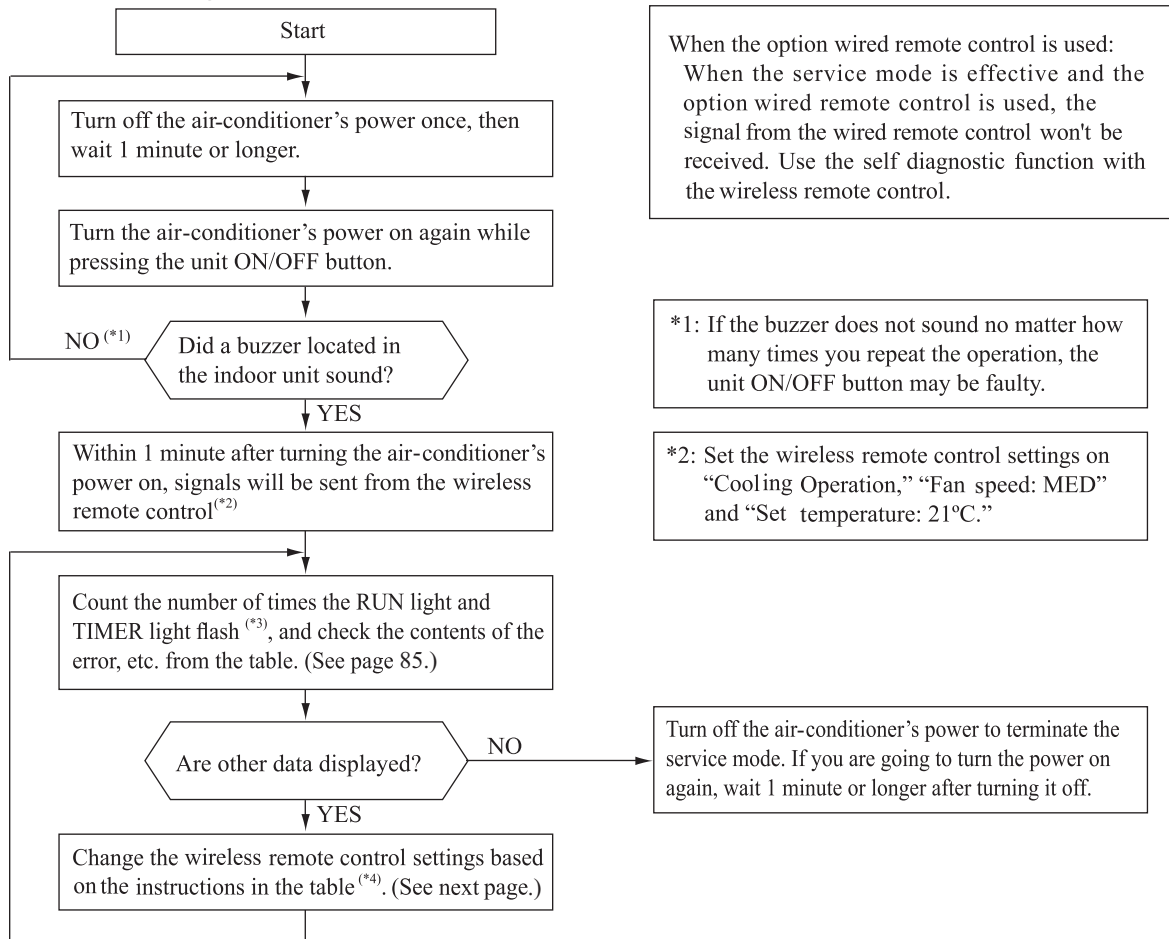

*3: To count the number of flashes in the service mode, count the number of flashes after the light lights up for 1.5 second initially (start signal). (The time that the light lights up for 1.5 second (start signal) is not counted in the number of flashes.)

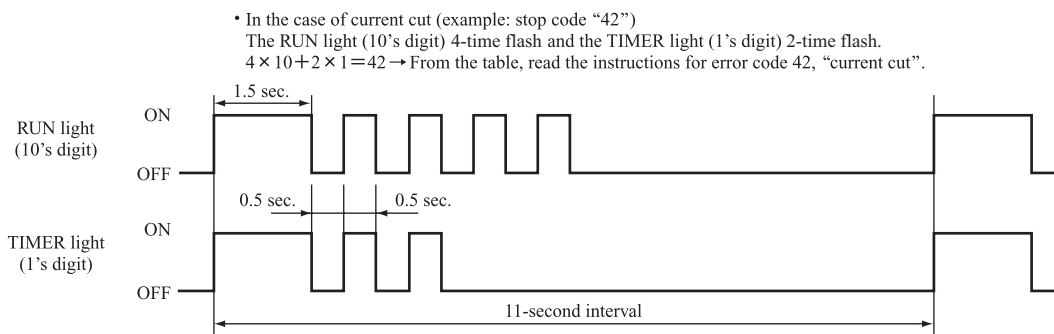

*4: When in the service mode, when the wireless remote control settings (operation mode, fan speed mode, temperature setting) are set as shown in the following table and sent to the air-conditioner unit, the unit switches to display of service data.

(i) Self-diagnosis data

What are Self-diagnosis data?

These are control data (reasons for stops, temperature at each sensor, wireless remote control information) from the time when there were error displays (abnormal stops) in the indoor unit in the past.

Data from up to 5 previous occasions are stored in memory. Data older than the 5th previous occasion are erased.

The temperature setting indicates how many occasions previous to the present setting the error display data are and the operation mode and fan speed mode data show the type of data.

| Wireless remote control setting | | Contents of output data |
|---------------------------------|----------------|--|
| Operation mode | Fan speed mode | |
| Cooling | MED | Displays the reason for stopping display in the past (error code). |
| | HI | Displays the room temperature sensor temperature at the time the error code was displayed in the past. |
| | AUTO | Displays the indoor heat exchanger temperature sensor temperature at the time the error code was displayed in the past. |
| Heating | LO | Displays the wireless remote control information at the time the error code was displayed in the past. |
| | MED | Displays the outdoor air temperature sensor temperature at the time the error code was displayed in the past. |
| | HI | Displays the outdoor heat exchanger temperature sensor temperature at the time the error code was displayed in the past. |
| | AUTO | Displays the discharge pipe temperature sensor temperature at the time the error code was displayed in the past. |

| Wireless remote control setting | Indicates the number of occasions previous to the present the error display data are from. |
|---------------------------------|--|
| Temperature setting | |
| 21°C | 1 time previous (previous time) |
| 22°C | 2 times previous |
| 23°C | 3 times previous |
| 24°C | 4 times previous |
| 25°C | 5 times previous |

Only for indoor heat exchanger sensor 2

| Wireless remote control setting | Indicates the number of occasions previous to the present the error display data are from. |
|---------------------------------|--|
| Temperature setting | |
| 26°C | 1 time previous (previous time) |
| 27°C | 2 times previous |
| 28°C | 3 times previous |
| 29°C | 4 times previous |
| 30°C | 5 times previous |

(Example)

| Wireless remote control setting | | | Displayed data |
|---------------------------------|----------------|---------------------|---|
| Operation mode | Fan speed mode | Temperature setting | |
| Cooling | MED | 21°C | Displays the reason for the stop (error code) the previous time an error was displayed. |
| | | 22°C | Displays the reason for the stop (error code) 2 times previous when an error was displayed. |
| | | 23°C | Displays the reason for the stop (error code) 3 times previous when an error was displayed. |
| | | 24°C | Displays the reason for the stop (error code) 4 times previous when an error was displayed. |
| | | 25°C | Displays the reason for the stop (error code) 5 times previous when an error was displayed. |

(ii) Stop data

| Wireless remote control setting | | | Displayed data |
|---------------------------------|----------------|---------------------|---|
| Operation mode | Fan speed mode | Temperature setting | |
| Cooling | LO | 21°C | Displays the reason for the stop (stop code) the previous time when the air-conditioner was stopped by protective stop control. |
| | | 22°C | Displays the reason for the stop (stop code) 2 times previous when the air-conditioner was stopped by protective stop control. |
| | | 23°C | Displays the reason for the stop (stop code) 3 times previous when the air-conditioner was stopped by protective stop control. |
| | | 24°C | Displays the reason for the stop (stop code) 4 times previous when the air-conditioner was stopped by protective stop control. |
| | | 25°C | Displays the reason for the stop (stop code) 5 times previous when the air-conditioner was stopped by protective stop control. |
| | | 26°C | Displays the reason for the stop (stop code) 6 times previous when the air-conditioner was stopped by protective stop control. |
| | | 27°C | Displays the reason for the stop (stop code) 7 times previous when the air-conditioner was stopped by protective stop control. |
| | | 28°C | Displays the reason for the stop (stop code) 8 times previous when the air-conditioner was stopped by protective stop control. |
| | | 29°C | Displays the reason for the stop (stop code) 9 times previous when the air-conditioner was stopped by protective stop control. |
| | | 30°C | Displays the reason for the stop (stop code) 10 times previous when the air-conditioner was stopped by protective stop control. |

(c) Error code, stop code table (Assignment of error codes and stop codes is done in common for all models.)

| Number of flashes when in service mode | | Stop code or Error code | Error content | Cause | Occurrence conditions | Error display | Auto recovery |
|--|-------------------------|-------------------------|--|---|--|----------------|---------------|
| RUN light (10's digit) | TIMER light (1's digit) | | | | | | |
| OFF | OFF | 0 | Normal | — | — | — | — |
| | 1-time flash | 01 | Error of wired remote control wiring | Broken wired remote control wire, defective indoor unit PCB | The wired remote control wire Y is open. The wired remote control wires X and Y are reversely connected. Noise is penetrating the wired remote control lines. The wired remote control or indoor unit PCB is faulty. | — | ○ |
| | 5-time flash | 05 | Can not receive signals for 35 seconds (if communications have recovered) | Power source is faulty. Power source cables and signal lines are improperly wired. Indoor or outdoor unit sub PCB are faulty | When 35 seconds passes without communications signals from either the outdoor unit or the indoor unit being detected correctly. | ○ | — |
| 3-time flash | 5-time flash | 35 | Cooling high pressure control | Cooling overload operation. Outdoor unit fan speed drops. Outdoor heat exchanger temperature sensor is short circuit. | When the outdoor heat exchanger temperature sensor's value exceeds the set value. | ○ (5 times) | ○ |
| | 6-time flash | 36 | Compressor overheat 115°C | Refrigerant is insufficient. Discharge pipe temperature sensor is faulty Service valve is closed. | When the discharge pipe temperature sensor's value exceeds the set value. | ○ (2 times) | ○ |
| | 7-time flash | 37 | Outdoor heat exchanger temperature sensor is abnormal | Outdoor heat exchanger temperature sensor wire is disconnected. Connector connections are poor Outdoor unit main PCB is faulty | -55°C or lower is detected for 5 seconds continuously 3 times within 40 minutes after initial detection of this anomalous temperature. Or-55°C higher is detected for 5 seconds continuously within 20 seconds after power ON. | ○ (3 times) | ○ |
| | 8-time flash | 38 | Outdoor air temperature sensor is abnormal | Outdoor air temperature sensor wire is disconnected. Connector connections are poor Outdoor unit main PCB is faulty | -55°C or lower is detected for 5 seconds continuously 3 times within 40 minutes after initial detection of this anomalous temperature. Or-55°C higher is detected for 5 seconds continuously within 20 seconds after power ON. | ○ (3 times) | ○ |
| | 9-time flash | 39 | Discharge pipe temperature sensor is abnormal (anomalous stop) | Discharge pipe temperature sensor wire is disconnected. Connector connections are poor. Outdoor unit main PCB is faulty | -25°C or lower is detected for 5 seconds continuously 3 times within 40 minutes after initial detection of this anomalous temperature. | ○ (3 times) | ○ |
| 4-time flash | 2-time flash | 42 | Current cut | Compressor lock. Compressor wiring short circuit. Compressor output is open phase. Outdoor unit main PCB is faulty Service valve is closed. Electronic expansion valve is faulty. Compressor is faulty. | Compressor start fails 42 times in succession and the reason for the final failure is current cut. | ○ (2 times) | ○ |
| | 5-time flash | 45 | Anomalous outdoor unit sub PCB communication | Outdoor unit sub PCB faulty. Poor connection of wire between outdoor unit sub PCB-main PCB. | Communication error for 15 minutes: Detected more than 15 seconds 4 times. | ○ | ○ |
| | 7-time flash | 47 | Active filter voltage error | Defective active filter. | When the wrong voltage connected for the power source. When the outdoor unit main PCB is faulty. | ○ | — |
| | 8-time flash | 48 | Outdoor fan motor is abnormal | Outdoor fan motor is faulty. Connector connections are poor. Outdoor unit main PCB is faulty | When a fan speed of 75 min ⁻¹ or lower continues for 30 seconds or longer. | ○ (3 times) | ○ |
| 5-time flash | 1-time flash | 51 | Short circuit in the power transistor (high side) Current cut circuit breakdown | Outdoor unit main PCB is faulty Power transistor is damaged. | When it is judged that the power transistor was damaged at the time the compressor started. | ○ | — |
| | 3-time flash | 53 | Suction pipe sensor is abnormal | Suction pipe temperature sensor wire is disconnected. Connector connections are poor. Outdoor unit sub PCB is faulty | -55°C or lower is detected for 5 seconds continuously 3 times within 40 minutes after initial detection of this anomalous temperature. Or-55°C higher is detected for 5 seconds continuously within 20 seconds after compressor ON. | ○ (3 times) | ○ |
| | 7-time flash | 57 | Refrigeration cycle system protective control | Service valve is closed. Refrigerant is insufficient. | When refrigeration cycle system protective control operates. | ○ (3 times) | ○ |
| | 8-time flash | 58 | Current safe | Refrigerant is overcharge. Compressor lock. Overload operation. | When there is a current safe stop during operation. | — | ○ |
| | 9-time flash | 59 | Compressor wiring is unconnection Voltage drop | Compressor wiring is disconnected. Power transistor is damaged. Power source construction is defective. Outdoor unit main PCB is faulty Compressor is faulty | When the current is 1A or less at the time the compressor started. When the power source voltage drops during operation. | ○ | ○ |
| 6-time flash | OFF | 60 | Rotor lock | Compressor is faulty. Compressor output is open phase. Electronic expansion valve is faulty. Overload operation. Outdoor unit main PCB is faulty. | After the compressor starts, when the compressor stops due to rotor lock. | ○ (2 times) | ○ |
| | 1-time flash | 61 | Connection lines between the indoor and outdoor units are faulty | Connection lines are faulty. Indoor or outdoor unit sub PCB are faulty | When 10 seconds passes after the power is turned on without communications signals from the indoor or outdoor unit being detected correctly. | ○ | — |
| | 2-time flash | 62 | Serial transmission error | Indoor or outdoor unit sub PCB are faulty Noise is causing faulty operation. | When 7 minute 35 seconds passes without communications signals from either the outdoor unit or the indoor unit being detected correctly. | ○ | — |
| 8-time flash | OFF | 80 | Indoor fan motor is abnormal | Indoor fan motor is faulty. Connector connections are poor. Indoor unit PCB is faulty | When the indoor fan motor is detected to be running at 300 min ⁻¹ or lower speed with the fan motor in the ON condition while the air-conditioner is running. | ○ | — |
| | 2-time flash | 82 | Indoor heat exchanger temperature sensor is abnormal (anomalous stop) | Indoor heat exchanger temperature sensor wire is disconnected. Connector connections are poor | When a temperature of -28°C or lower is sensed continuously for 40 minutes during heating operation. (the compressor stops). | ○ | — |
| | 4-time flash | 84 | Anti-condensation control | High humidity condition. Humidity sensor is faulty. | Anti-condensation prevention control is operating. | — | ○ |
| | 5-time flash | 85 | Anti-frost control | Indoor unit fan speed drops. Indoor heat exchanger temperature sensor is broken wire. | When the anti-frost control operates and the compressor stops during cooling operation. | — | ○ |
| | 6-time flash | 86 | Heating high pressure control | Heating overload operation. Indoor unit fan speed drops. Indoor heat exchanger temperature sensor is short circuit. | When high pressure control operates during heating operation and the compressor stops. | — | ○ |
| | 7-time flash | 87 | Drain trouble | Defective drain pump (DM). broken drain pump wire Anomalous float switch operation Defective indoor unit PCB faulty | If the float switch OPEN is detected for 3 seconds continuously or if float switch connector or wire is disconnected. | ○ (4 times) | — |

Notes (1) The number of flashes when in the service mode do not include the 1.5 second period when the lights light up at first (start signal). (See the example shown below.)

• In the case of current cut (example: stop code "42")
 The RUN light (10's digit) 4-time flash and the TIMER light (1's digit) 2-time flash.
 $4 \times 10 + 2 \times 1 = 42 \rightarrow$ From the table, read the instructions for error code 42, "current cut".

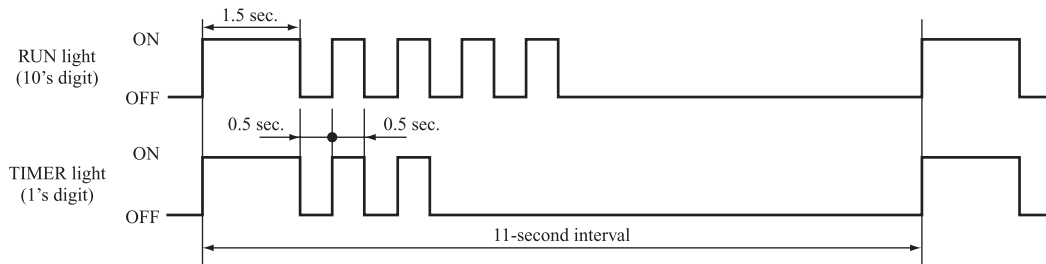

- (2) Error display:
 – Is not displayed. (automatic recovery only)
 Displayed.
 If there is a () displayed, the error display shows the number of times that an auto recovery occurred for the same reason has reached the number of times in ().
 If no () is displayed, the error display shows that the trouble has occurred once.
- (3) Auto recovery:
 – Does not occur
 Auto recovery occurs

(d) Operation mode, Fan speed mode information tables

(i) Operation mode

| Display pattern when in service mode | Operation mode when there is an abnormal stop |
|--------------------------------------|---|
| RUN light (10's digit) | |
| — | AUTO |
| 1-time flash | DRY |
| 2-time flash | COOL |
| 3-time flash | FAN |
| 4-time flash | HEAT |

(ii) Fan speed mode

| Display pattern when in service mode | Fan speed mode when there is an abnormal stop |
|--------------------------------------|---|
| TIMER light (1's digit) | |
| — | AUTO |
| 2-time flash | HI |
| 3-time flash | MED |
| 4-time flash | LO |
| 5-time flash | ULO |
| 6-time flash | HI POWER |
| 7-time flash | ECONO |

* If no data are recorded (error code is normal), the information display in the operation mode and fan speed mode becomes as follows.

| Mode | Display when error code is normal |
|-----------------------|-----------------------------------|
| Operation mode | AUTO |
| Fan speed mode | AUTO |

(Example): Operation mode: COOL, Fan speed mode: HI

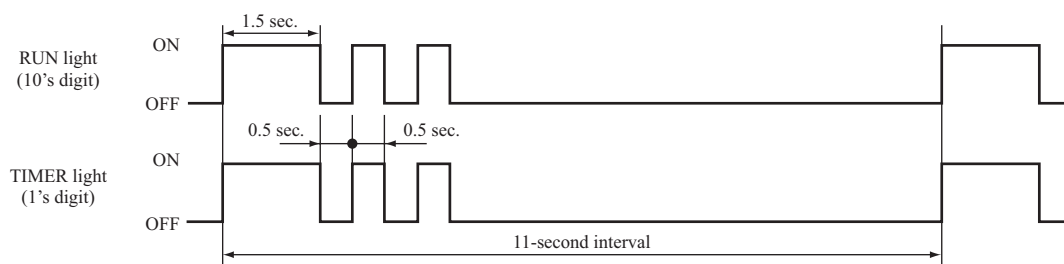

(e) Temperature information

- (i) Room temperature sensor, indoor heat exchanger temperature sensor, outdoor air temperature sensor, outdoor heat exchanger temperature sensor temperature

Unit: °C

| Buzzer sound | RUN light (10's digit) | TIMER light (1's digit) | | | | | | | | | | |
|--------------------------------|---------------------------|----------------------------|-----|-----|-----|-----|-----|-----|-----|-----|-----|--|
| | | 0 | 1 | 2 | 3 | 4 | 5 | 6 | 7 | 8 | 9 | |
| Yes (sounds for 0.1 second) | 6 | -60 | -61 | -62 | -63 | -64 | | | | | | |
| | 5 | -50 | -51 | -52 | -53 | -54 | -55 | -56 | -57 | -58 | -59 | |
| | 4 | -40 | -41 | -42 | -43 | -44 | -45 | -46 | -47 | -48 | -49 | |
| | 3 | -30 | -31 | -32 | -33 | -34 | -35 | -36 | -37 | -38 | -39 | |
| | 2 | -20 | -21 | -22 | -23 | -24 | -25 | -26 | -27 | -28 | -29 | |
| | 1 | -10 | -11 | -12 | -13 | -14 | -15 | -16 | -17 | -18 | -19 | |
| | 0 | | -1 | -2 | -3 | -4 | -5 | -6 | -7 | -8 | -9 | |
| No (does not sound) | 0 | 0 | 1 | 2 | 3 | 4 | 5 | 6 | 7 | 8 | 9 | |
| | 1 | 10 | 11 | 12 | 13 | 14 | 15 | 16 | 17 | 18 | 19 | |
| | 2 | 20 | 21 | 22 | 23 | 24 | 25 | 26 | 27 | 28 | 29 | |
| | 3 | 30 | 31 | 32 | 33 | 34 | 35 | 36 | 37 | 38 | 39 | |
| | 4 | 40 | 41 | 42 | 43 | 44 | 45 | 46 | 47 | 48 | 49 | |
| | 5 | 50 | 51 | 52 | 53 | 54 | 55 | 56 | 57 | 58 | 59 | |
| | 6 | 60 | 61 | 62 | 63 | 64 | 65 | 66 | 67 | 68 | 69 | |
| | 7 | 70 | 71 | 72 | 73 | 74 | 75 | 76 | 77 | 78 | 79 | |
| | 8 | 80 | 81 | 82 | 83 | 84 | 85 | 86 | 87 | 88 | 89 | |
| | 9 | 90 | 91 | 92 | 93 | 94 | 95 | 96 | 97 | 98 | 99 | |

* If no data are recorded (error code is normal), the display for each temperature information becomes as shown below.

| Sensor name | Sensor value displayed when the error code is normal |
|---|--|
| Room temperature sensor | -64°C |
| Indoor heat exchanger temperature sensor | -64°C |
| Outdoor air temperature sensor | -64°C |
| Outdoor heat exchanger temperature sensor | -64°C |

(Example) Outdoor heat exchanger temperature data: “-9°C”

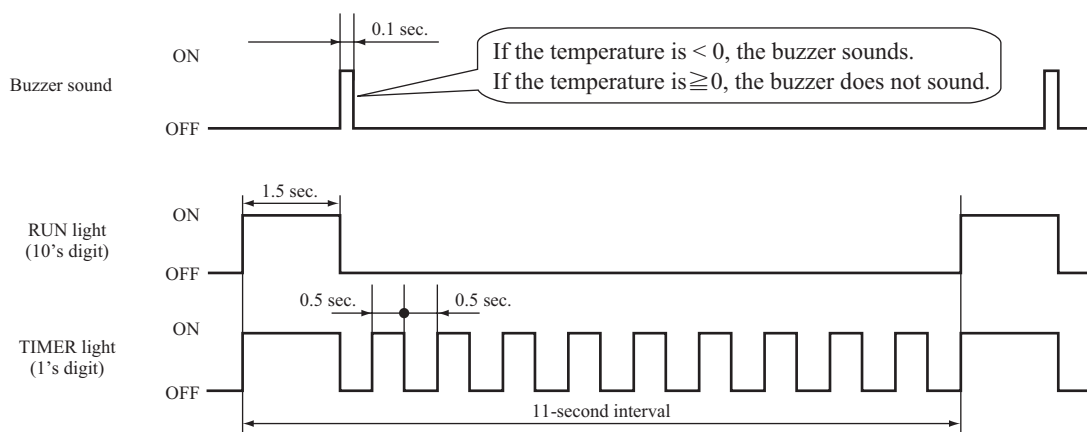

(ii) Discharge pipe temperature sensor temperature

Unit: °C

| Buzzer sound | RUN light (10's digit) | TIMER light (1's digit) | | | | | | | | | | | |
|--------------------------------|---------------------------|----------------------------|-----|-----|-----|-----|-----|-----|-----|-----|-----|--|--|
| | | 0 | 1 | 2 | 3 | 4 | 5 | 6 | 7 | 8 | 9 | | |
| Yes (sounds for 0.1 second) | 3 | -60 | -62 | -64 | | | | | | | | | |
| | 2 | -40 | -42 | -44 | -46 | -48 | -50 | -52 | -54 | -56 | -58 | | |
| | 1 | -20 | -22 | -24 | -26 | -28 | -30 | -32 | -34 | -36 | -38 | | |
| | 0 | / | -2 | -4 | -6 | -8 | -10 | -12 | -14 | -16 | -18 | | |
| No (does not sound) | 0 | 0 | 2 | 4 | 6 | 8 | 10 | 12 | 14 | 16 | 18 | | |
| | 1 | 20 | 22 | 24 | 26 | 28 | 30 | 32 | 34 | 36 | 38 | | |
| | 2 | 40 | 42 | 44 | 46 | 48 | 50 | 52 | 54 | 56 | 58 | | |
| | 3 | 60 | 62 | 64 | 66 | 68 | 70 | 72 | 74 | 76 | 78 | | |
| | 4 | 80 | 82 | 84 | 86 | 88 | 90 | 92 | 94 | 96 | 98 | | |
| | 5 | 100 | 102 | 104 | 106 | 108 | 110 | 112 | 114 | 116 | 118 | | |
| | 6 | 120 | 122 | 124 | 126 | 128 | 130 | 132 | 134 | 136 | 138 | | |
| | 7 | 140 | 142 | 144 | 146 | 148 | 150 | | | | | | |

* If no data are recorded (error code is normal), the display for each temperature information becomes as shown below.

| Sensor name | Sensor value displayed when the error code is normal |
|-----------------------------------|--|
| Discharge pipe temperature sensor | -64°C |

(Example) Discharge pipe temperature data: "122°C"

* In the case of discharge pipe data, multiply the reading value by 2. (Below, 61 x 2 = "122°C")

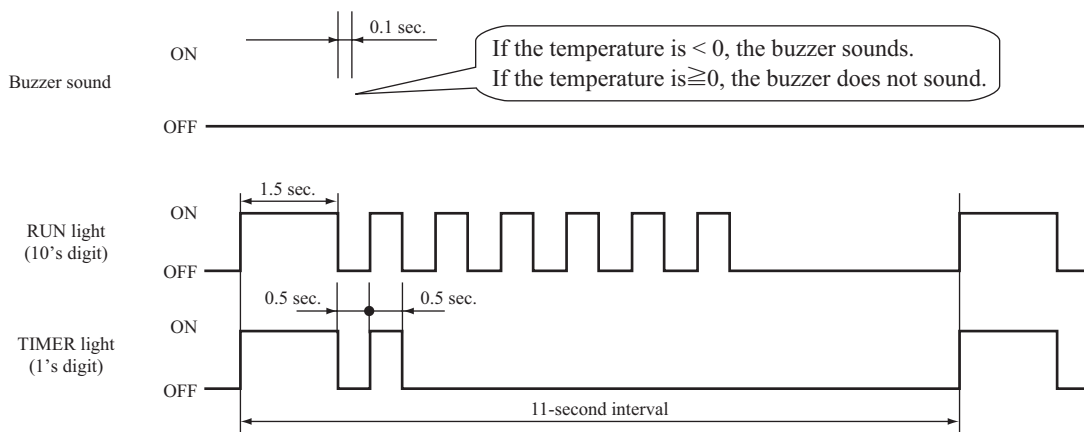

Service data record form

| Customer | | | | Model | | | |
|----------------------------------|----------------|--|---|------------------|-------------------|---------------------|-----------------|
| Date of investigation | | | | | | | |
| Machine name | | | | | | | |
| Content of complaint | | | | | | | |
| Wireless remote control settings | | | Content of displayed data | Display results | | | Display content |
| Temperature setting | Operation mode | Fan speed mode | | Buzzer (Yes/No.) | RUN light (Times) | TIMER light (Times) | |
| 21 | Cooling | MED | Error code on previous occasion. | / | | | |
| | | HI | Room temperature sensor on previous occasion. | | | | |
| | | AUTO | Indoor heat exchanger temperature sensor 1 on previous occasion. | | | | |
| | Heating | LO | Wireless remote control information on previous occasion. | / | | | |
| | | MED | Outdoor air temperature sensor on previous occasion. | | | | |
| | | HI | Outdoor heat exchanger temperature sensor on previous occasion. | | | | |
| | AUTO | Discharge pipe temperature sensor on previous occasion. | | | | | |
| 26 | Cooling | AUTO | Indoor heat exchanger temperature sensor 2 on previous occasion. | | | | |
| 22 | Cooling | MED | Error code on second previous occasion. | / | | | |
| | | HI | Room temperature sensor on second previous occasion. | | | | |
| | | AUTO | Indoor heat exchanger temperature sensor 1 on second previous occasion. | | | | |
| | Heating | LO | Wireless remote control information on second previous occasion. | / | | | |
| | | MED | Outdoor air temperature sensor on second previous occasion. | | | | |
| | | HI | Outdoor heat exchanger temperature sensor on second previous occasion. | | | | |
| | AUTO | Discharge pipe temperature sensor on second previous occasion. | | | | | |
| 27 | Cooling | AUTO | Indoor heat exchanger temperature sensor 2 on second occasion. | | | | |
| 23 | Cooling | MED | Error code on third previous occasion. | / | | | |
| | | HI | Room temperature sensor on third previous occasion. | | | | |
| | | AUTO | Indoor heat exchanger temperature sensor 1 on third previous occasion. | | | | |
| | Heating | LO | Wireless remote control information on third previous occasion. | / | | | |
| | | MED | Outdoor air temperature sensor on third previous occasion. | | | | |
| | | HI | Outdoor heat exchanger temperature sensor on third previous occasion. | | | | |
| | AUTO | Discharge pipe temperature sensor on third previous occasion. | | | | | |
| 28 | Cooling | AUTO | Indoor heat exchanger temperature sensor 2 on third occasion. | | | | |
| 24 | Cooling | MED | Error code on fourth previous occasion. | / | | | |
| | | HI | Room temperature sensor on fourth previous occasion. | | | | |
| | | AUTO | Indoor heat exchanger temperature sensor 1 on fourth previous occasion. | | | | |
| | Heating | LO | Wireless remote control information on fourth previous occasion. | / | | | |
| | | MED | Outdoor air temperature sensor on fourth previous occasion. | | | | |
| | | HI | Outdoor heat exchanger temperature sensor on fourth previous occasion. | | | | |
| | AUTO | Discharge pipe temperature sensor on fourth previous occasion. | | | | | |
| 29 | Cooling | AUTO | Indoor heat exchanger temperature sensor 2 on fourth occasion. | | | | |
| 25 | Cooling | MED | Error code on fifth previous occasion. | / | | | |
| | | HI | Room temperature sensor on fifth previous occasion. | | | | |
| | | AUTO | Indoor heat exchanger temperature sensor 1 on fifth previous occasion. | | | | |
| | Heating | LO | Wireless remote control information on fifth previous occasion. | / | | | |
| | | MED | Outdoor air temperature sensor on fifth previous occasion. | | | | |
| | | HI | Outdoor heat exchanger temperature sensor on fifth previous occasion. | | | | |
| | AUTO | Discharge pipe temperature sensor on fifth previous occasion. | | | | | |
| 30 | Cooling | AUTO | Indoor heat exchanger temperature sensor 2 on fifth occasion. | | | | |
| 21 | Cooling | LO | Stop code on previous occasion. | | | | |
| 22 | | | Stop code on second previous occasion. | | | | |
| 23 | | | Stop code on third previous occasion. | | | | |
| 24 | | | Stop code on fourth previous occasion. | | | | |
| 25 | | | Stop code on fifth previous occasion. | | | | |
| 26 | | | Stop code on sixth previous occasion. | | | | |
| 27 | | | Stop code on seventh previous occasion. | | | | |
| 28 | | | Stop code on eighth previous occasion. | | | | |
| 29 | | | Stop code on ninth previous occasion. | | | | |
| 30 | | | Stop code on tenth previous occasion. | | | | |
| Judgment | | | | | | | Examiner |
| Remarks | | | | | | | |

Note (1) In the case of indoor heat exchanger temperature sensor 2, match from 26 to 30 the temperature setting of wireless remote control. (Refer to page 83)

(7) Inspection procedures corresponding to detail of trouble

Sensor error

[Broken sensor wire, connector poor connection]

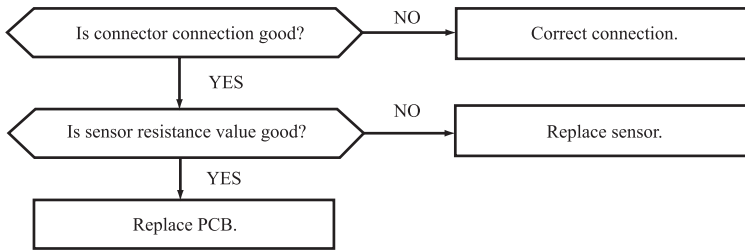

◆ Discharge pipe and power transistor sensor temperature characteristics

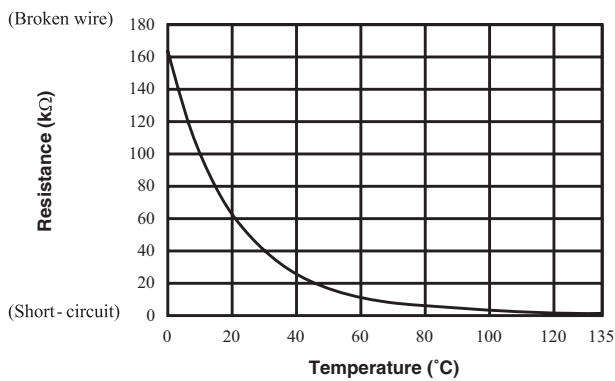

◆ Sensor temperature characteristics [Room temperature, indoor heat exchanger temperature, outdoor heat exchanger temperature, outdoor air temperature outdoor suction pipe temperature]

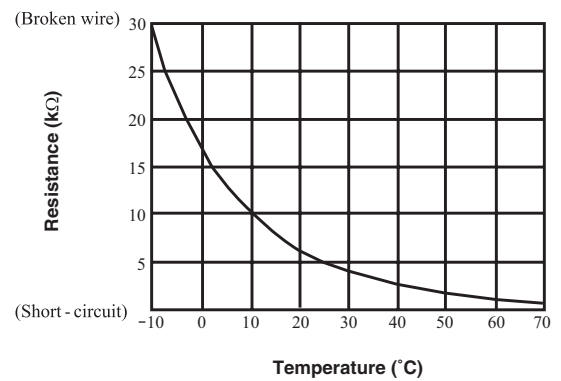

Indoor fan motor error

[Defective fan motor, connector poor connection, defective indoor unit PCB]

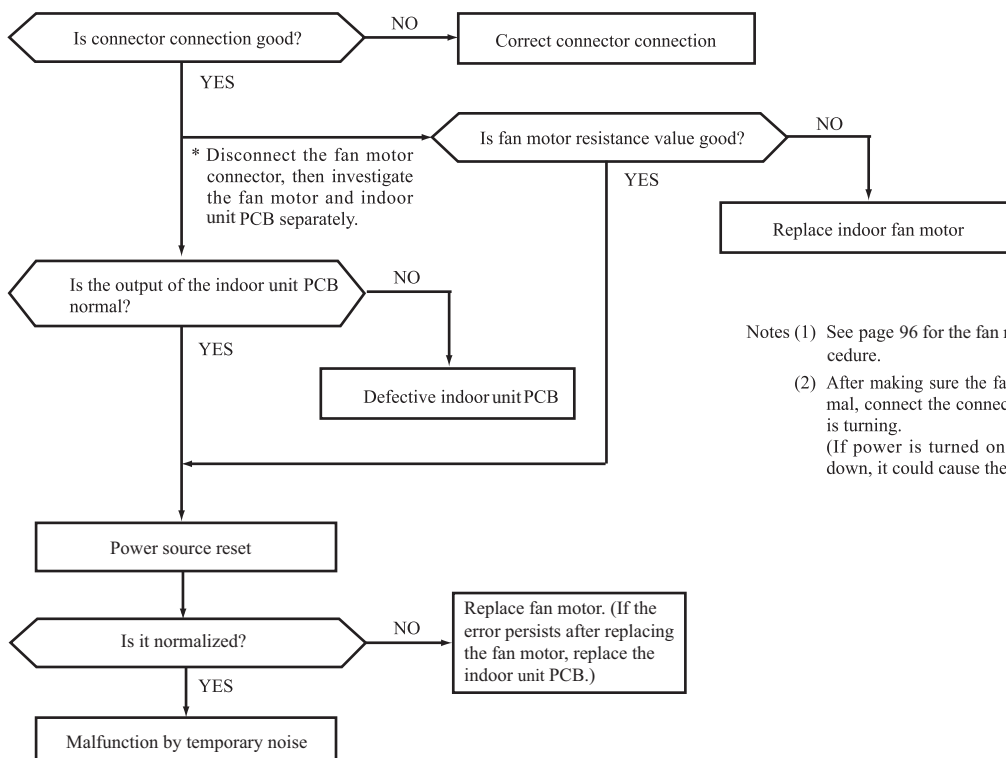

Notes (1) See page 96 for the fan motor and indoor unit PCB check procedure.

(2) After making sure the fan motor and indoor unit PCB are normal, connect the connectors and confirm that the fan motor is turning. (If power is turned on while one or the other is broken down, it could cause the other to break down also.)

Limit switch anomaly (SRK20, 25, 35, 50, 60ZSX-W only) [Defective limit switch, defective indoor unit control PCB, Defective air inlet panel set]

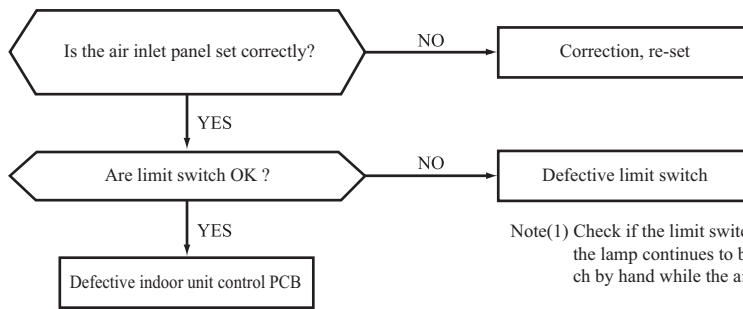

Note(1) Check if the limit switch functions properly or not by seeing whether the lamp continues to blink or can be reset by pressing the limit switch by hand while the air inlet panel is removed.

Current cut

[Compressor lock, Compressor wiring short circuit, Compressor output is open phase, Outdoor unit PCB is faulty, Service valve is closed, EEV is faulty, Compressor faulty.]

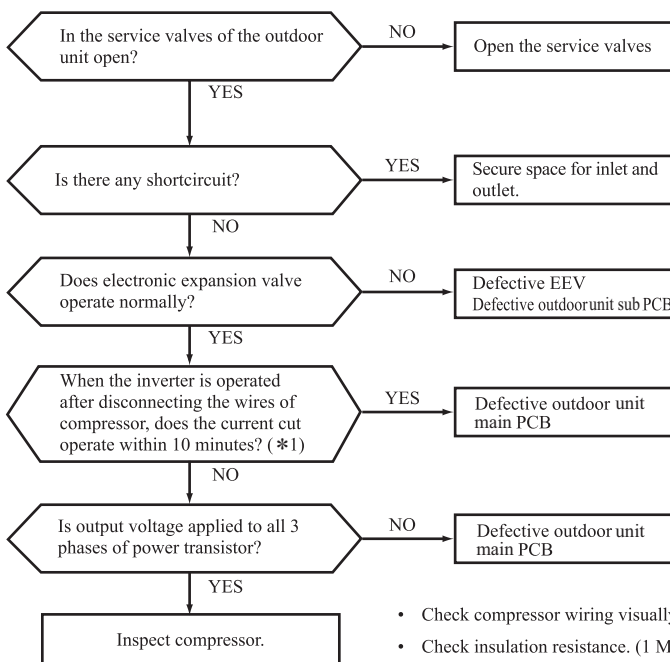

For inspection of electronic expansion valve, see page 99.

*1 If it is normal, it is the rotor lock problem.

- Check compressor wiring visually.
 - Check insulation resistance. (1 MΩ or over)
 - Check coil wire resistance. 1.154Ω or more at 20°C
- } If check results are normal, compressor is locked.

Current safe stop

[Overload operation, compressor lock, overcharge]

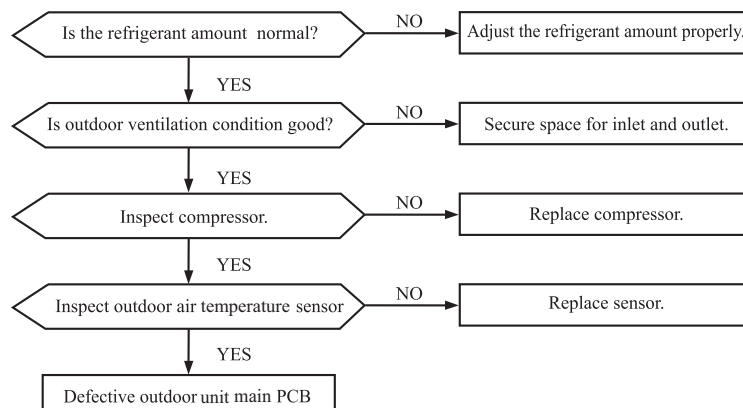

Over heat of compressor

[Gas shortage, defective discharge pipe temperature sensor]

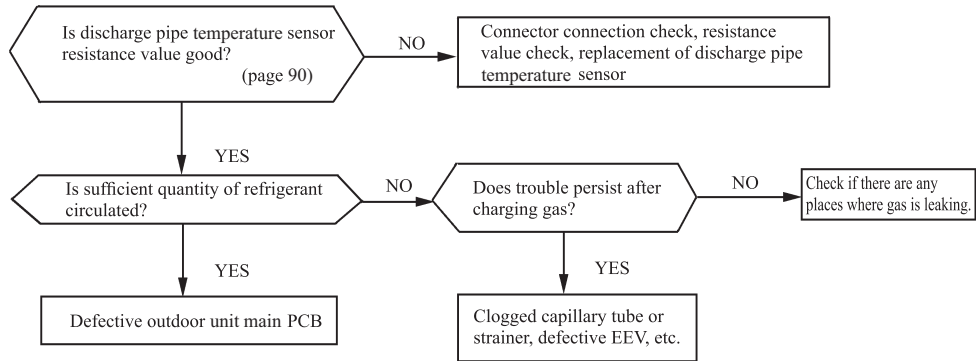

Error of signal transmission

[Wiring error including power cable, defective indoor/outdoor unit PCB]

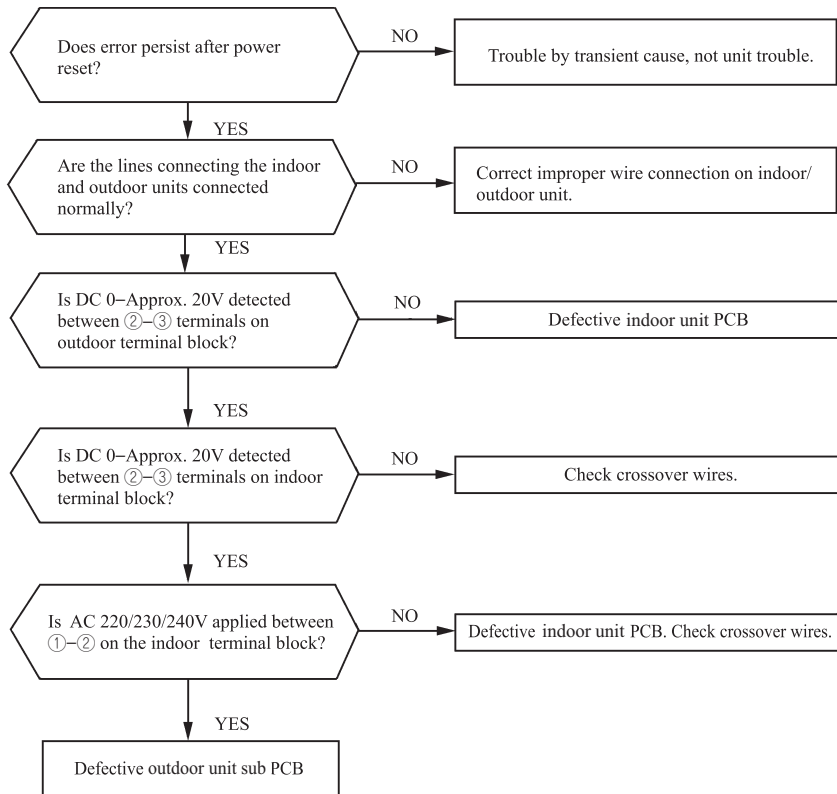

Trouble of outdoor unit

[Insufficient refrigerant amount, Faulty power transistor, Broken compressor wire]
 [Service valve close, Defective EEV, Defective outdoor unit PCB]

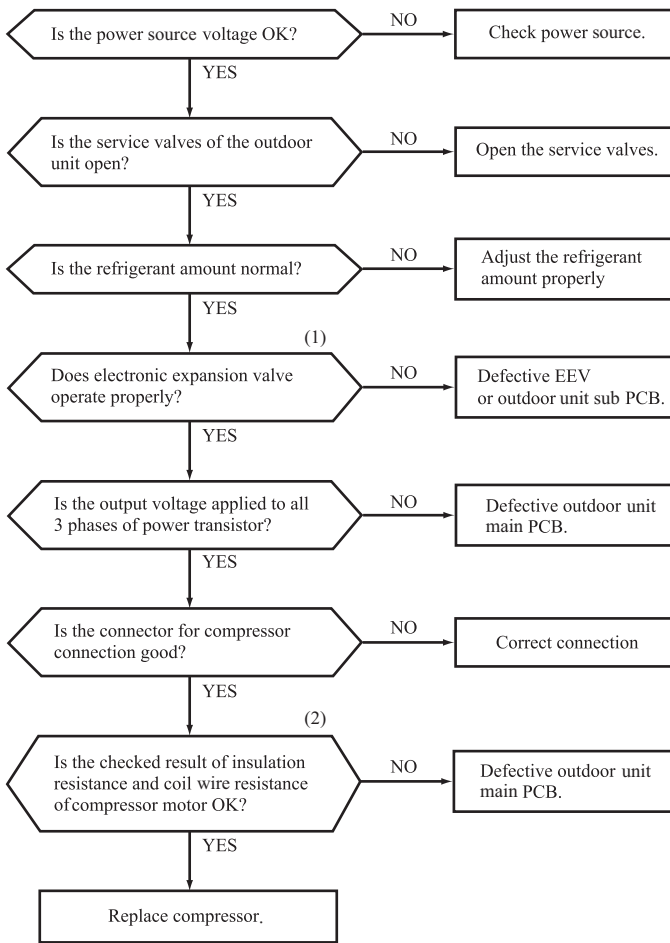

Proper power source voltages are as follows.
 (At the power source outlet)
 AC220V : AC198-242V
 AC230V : AC207-253V
 AC240V : AC216-264V

◆ Judgment of refrigerant quantity

(1) Phenomenon of insufficient refrigerant

- (a) Loss of capacity
- (b) Poor defrost operation
(Frost is not removed completely.)
- (c) Longer time of hot keep
(5-minutes or more)
(Normal time: Approx. 1-1 minute and 30 seconds)

Notes (1) For inspection of electronic expansion valve, see page 99.

(2) Check coil wire resistance, see page 91.

Outdoor fan motor error

[Defective fan motor, connector poor connection, defective outdoor unit PCB]

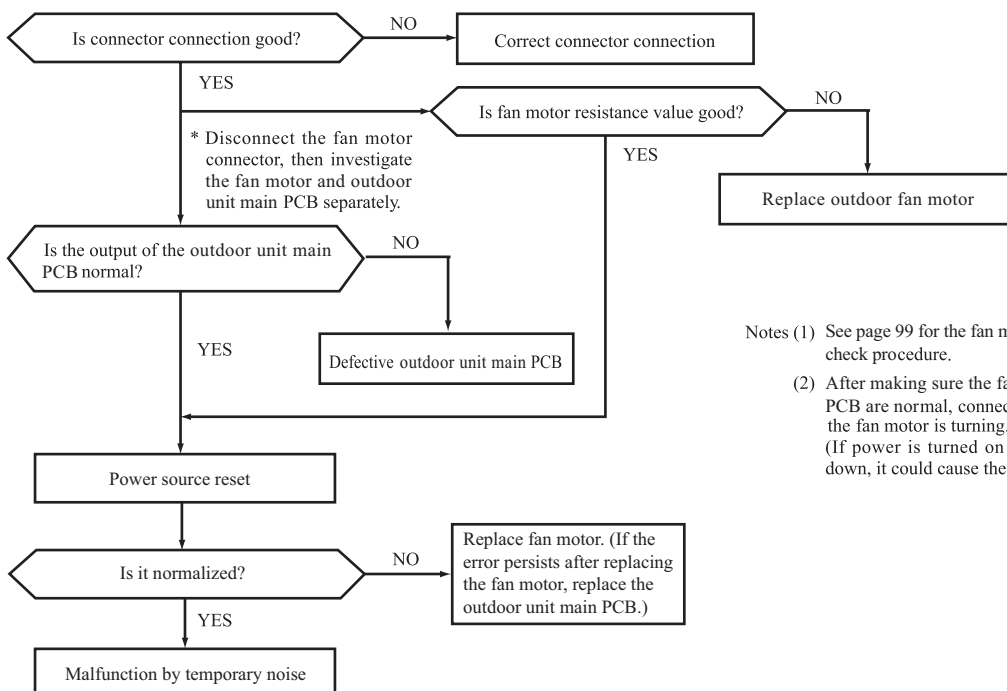

Notes (1) See page 99 for the fan motor and outdoor unit main PCB check procedure.

- (2) After making sure the fan motor and outdoor unit main PCB are normal, connect the connectors and confirm that the fan motor is turning.
(If power is turned on while one or the other is broken down, it could cause the other to break down also.)

Rotor lock

[Defective compressor, defective outdoor unit PCB]

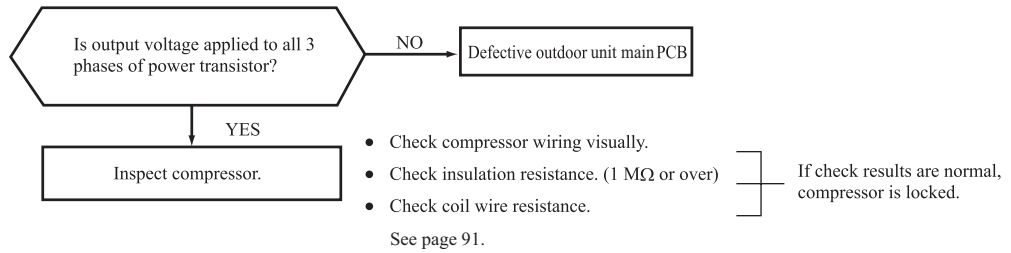

Drain abnormality (SRR only)

[Drain piping defective, pump defect, float switch, indoor unit PCB]

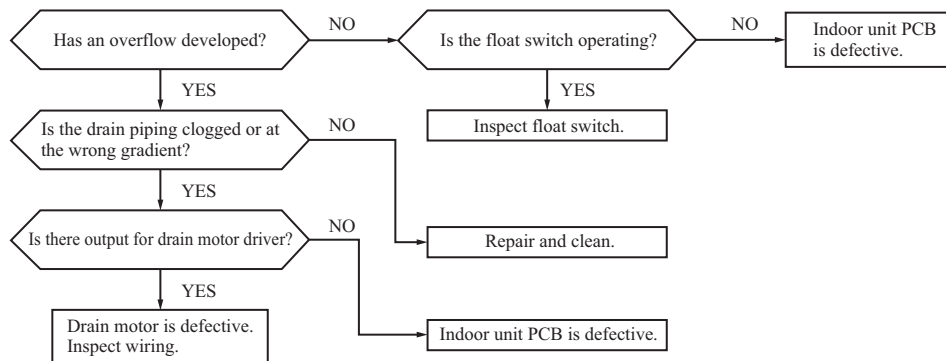

Service valve (gas side) closed operation

[Service valve (gas side) closed, Defective outdoor unit PCB]

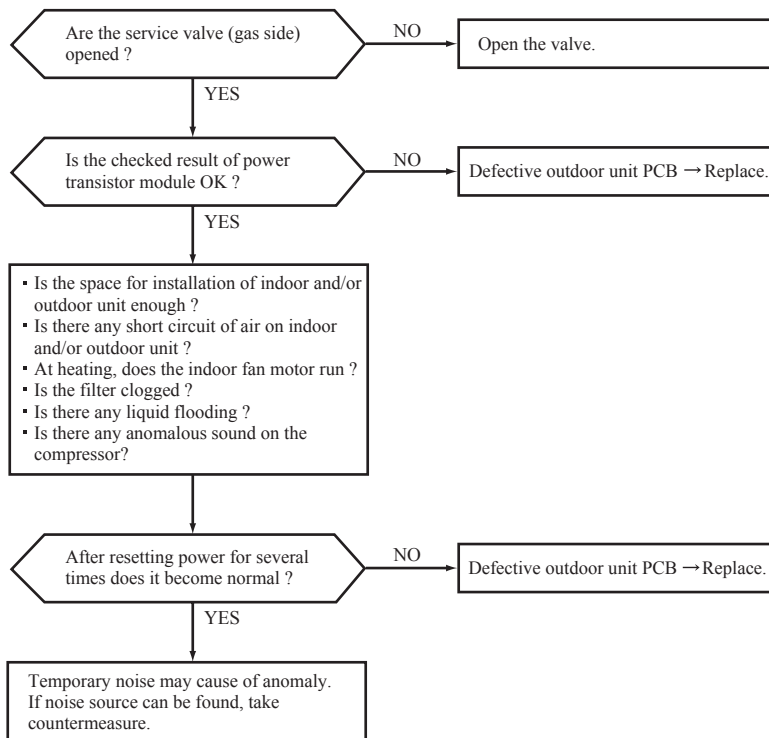

(8) Phenomenon observed after short-circuit, wire breakage on sensor

(a) Indoor unit

| Sensor | Operation mode | Phenomenon | |
|-----------------------------------|----------------|--|--|
| | | Shortcircuit | Disconnected wire |
| Room temperature sensor | Cooling | Release of continuous compressor operation command. | Continuous compressor operation command is not released. |
| | Heating | Continuous compressor operation command is not released. | Release of continuous compressor operation command. |
| Heat exchanger temperature sensor | Cooling | Freezing cycle system protection trips and stops the compressor. | Continuous compressor operation command is not released. (Anti-frosting) |
| | Heating | High pressure control mode (Compressor stop command) | Hot keep (Indoor fan stop) |
| Humidity sensor ⁽¹⁾ | Cooling | Refer to the table below. | Refer to the table below. |
| | Heating | Normal system operation is possible. | |

Note (1) Except SRK20, 25ZS-W, SRR series

■ Humidity sensor operation

| | Failure mode | Control input circuit reading | Air-conditioning system operation |
|-------------------|-----------------------------|-------------------------------|--|
| Disconnected wire | ① Disconnected wire | Humidity reading is 0% | Anti-condensation control is not done. |
| | ② Disconnected wire | | |
| | ①② Disconnected wire | | |
| Short circuit | ① and ② are short circuited | Humidity reading is 100% | Anti-condensation control keep doing. |

Remark: Do not perform a continuity check of the humidity sensor with a tester. If DC current is applied, it could damage the sensor.

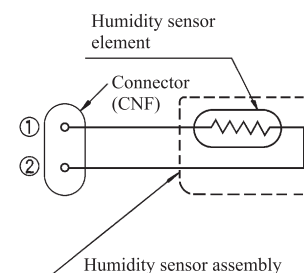

(b) Outdoor unit

| Sensor | Operation mode | Phenomenon | |
|-----------------------------------|----------------|---|--|
| | | Shortcircuit | Disconnected wire |
| Heat exchanger temperature sensor | Cooling | Compressor stop. | Compressor stop. |
| | Heating | Defrost operation is not performed. | Defrost operation is performed for 10 minutes at approx. 35 minutes. |
| Outdoor air temperature sensor | Cooling | The compressor cannot pick up its speed owing to the current safe so that the designed capacity is not achieved. | Compressor stop. |
| | Heating | The compressor cannot pick up its speed owing to the heating overload protection so that the designed capacity is not achieved. | Defrost operation is performed for 10 minutes at approx. 35 minutes. |
| Discharge pipe temperature sensor | All modes | Compressor overload protection is disabled. (Can be operated.) | Compressor stop |

(9) Checking the indoor electrical equipment

(a) Indoor unit PCB check procedure

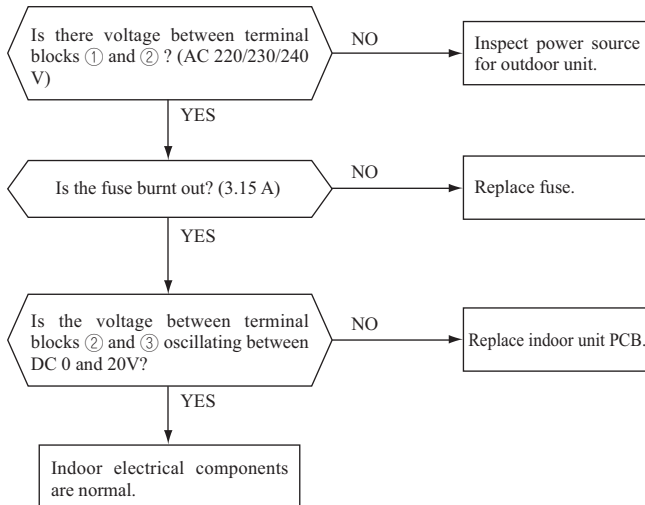

(b) Indoor fan motor check procedure

This is a diagnostic procedure for determining if the indoor fan motor or the indoor unit PCB is broken down.

(i) Indoor unit PCB output check

- 1) Turn off the power.
- 2) Remove the front panel, then disconnect the fan motor lead wire connector.
- 3) Turn on the power. If the unit operates when the ON/OFF button is pressed, if trouble is detected after the voltages in the following figure are output for approximately 30 seconds, it means that the indoor unit PCB is normal and the fan motor is broken down.

If the voltages in the following figure are not output at connector pins No. ①, ④ and ⑤, the indoor unit PCB has failed and the fan motor is normal.

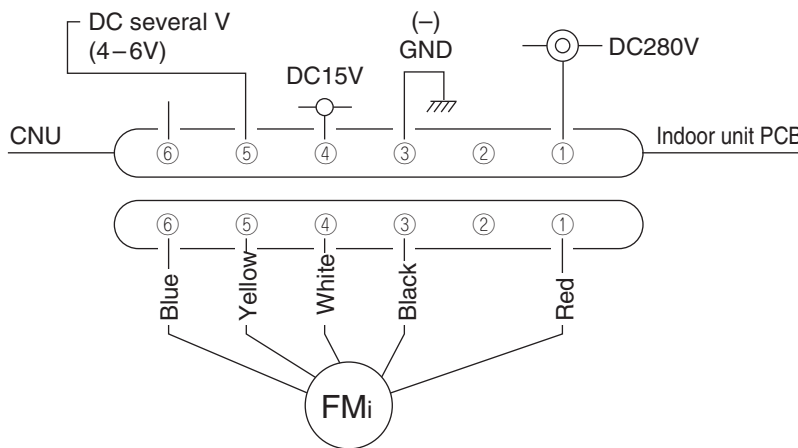

| Measuring point | Resistance when normal |
|-----------------|------------------------|
| ① - ③ | DC280V |
| ④ - ③ | DC15V |
| ⑤ - ③ | DC several V (4-6V) |

(ii) Fan motor resistance check

| Measuring point | Resistance when normal |
|-----------------------|------------------------|
| ① - ③ (Red - Black) | 20 MΩ or higher |
| ④ - ③ (White - Black) | 20 kΩ or higher |

- Notes (1) Remove the fan motor and measure it without power connected to it.
 (2) If the measured value is below the value when the motor is normal, it means that the fan motor is faulty.

(10) How to make sure of wireless remote control

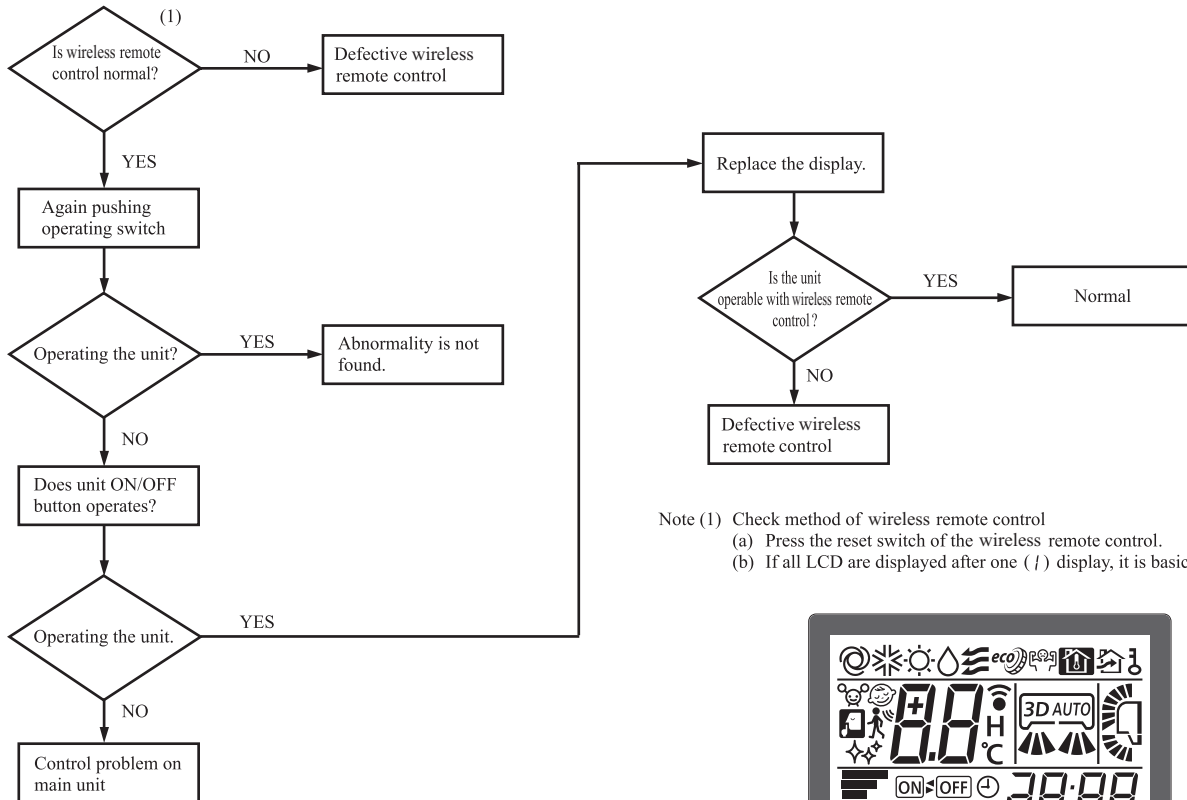

Note (1) Check method of wireless remote control
 (a) Press the reset switch of the wireless remote control.
 (b) If all LCD are displayed after one (1) display, it is basically normal.

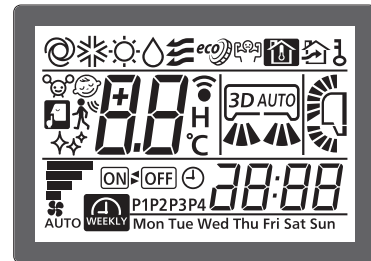

◆ Simplified check method of wireless remote control
 It is normal if the signal transmission section of the wireless remote control emits a whitish light at each transmission on the monitor of digital camera.

(11) Inspection procedure for blown fuse on the indoor and outdoor unit PCB

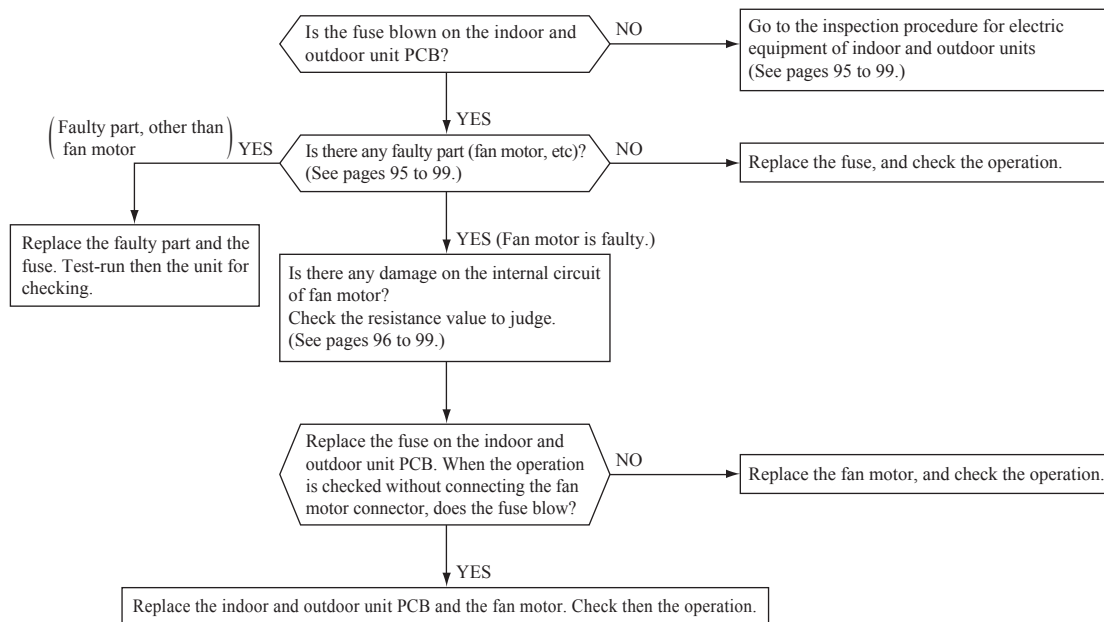

(12) Outdoor unit inspection points
Models SCM71ZS-W,80ZS-W

| Color marks | |
|-------------|----------------|
| Mark | Color |
| BK | Black |
| BL | Blue |
| BR | Brown |
| RD | Red |
| WH | White |
| GN | Green |
| YE | Yellow |
| Y/G | Yellow / Green |

⚠ CAUTION- HIGH VOLTAGE
 High voltage is produced in the control box. Don't touch electrical parts in the control box for 5 minutes after the unit is stopped.

◆ Power source and serial signal inspection
 ① to ②: AC 220/230/240V
 ② to ③: Normal if the voltage oscillates between DC 0 and approx. 20V

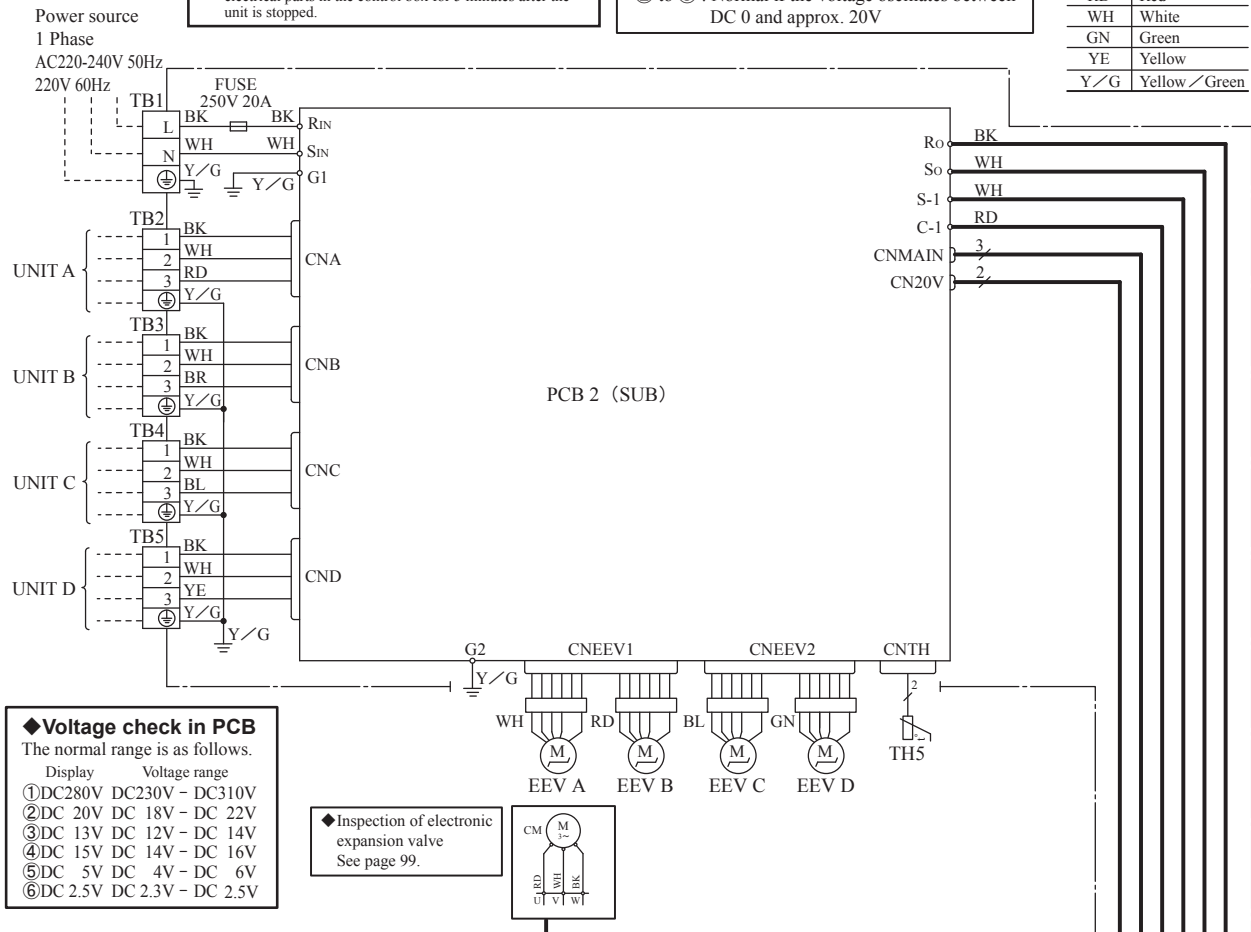

◆ Voltage check in PCB
 The normal range is as follows.

| Display | Voltage range |
|-----------|-------------------|
| ① DC 280V | DC 230V - DC 310V |
| ② DC 20V | DC 18V - DC 22V |
| ③ DC 13V | DC 12V - DC 14V |
| ④ DC 15V | DC 14V - DC 16V |
| ⑤ DC 5V | DC 4V - DC 6V |
| ⑥ DC 2.5V | DC 2.3V - DC 2.5V |

◆ Inspection of electronic expansion valve
 See page 99.

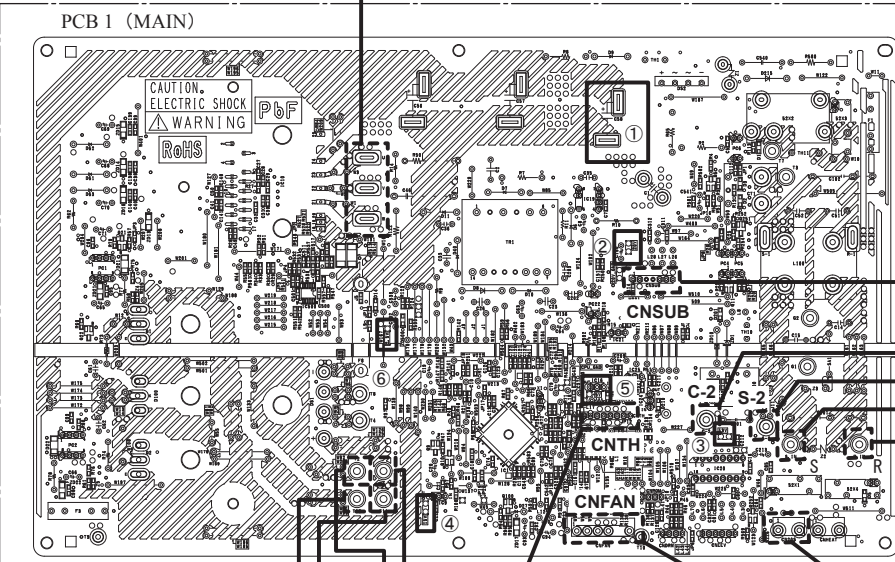

◆ Inspection power transistor
 Remove the fasten terminal and test output voltage

◆ Inspection of resistance value of sensor
 Remove the connector and check the resistance value. See the section of sensor characteristics on page 90.

◆ Inspection of outdoor fan motor
 See page 99.

(a) Inspection of electronic expansion valve

Electronic expansion valve operates for approx. 10 seconds after the power on, in order to determine its aperture. Check the operating sound and voltage during the period of time. (Voltage cannot be checked during operation in which only the aperture change occurs.)

- (i) If it is heard the sound of operating electronic expansion valve, it is almost normal.
- (ii) If the operating sound is not heard, check the output voltage.

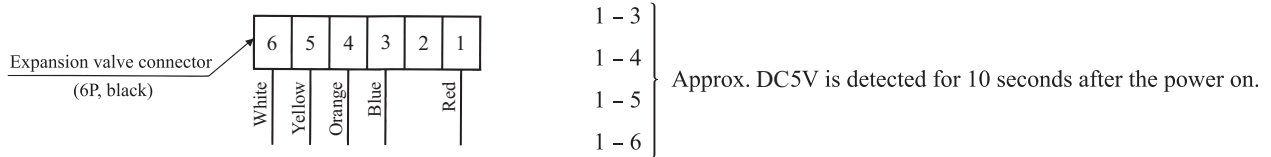

- (iii) If voltage is detected, the outdoor unit sub PCB is normal.
- (iv) If the expansion valve does not operate (no operating sound) while voltage is detected, the expansion valve is defective.

• Inspection of electronic expansion valve as a separate unit

Measure the resistance between terminals with an analog tester.

| Measuring point | Resistance when normal |
|-----------------|------------------------|
| 1-6 | 46 ± 4Ω (at 20°C) |
| 1-4 | |
| 1-3 | |
| 1-5 | |

(b) Outdoor fan motor check procedure

- When the outdoor fan motor error is detected, diagnose which of the outdoor fan motor or outdoor main PCB is defective.
- Diagnose this only after confirming that the indoor unit is normal.

(i) Outdoor unit main PCB output check

- 1) Turn off the power.
- 2) Disconnect the outdoor fan motor connector CNFAN.
- 3) When the outdoor unit is operated by inserting the power source plug and pressing (ON) the backup switch for more than 5 seconds, if the voltage of pin No. ② in the following figure is output for 30 seconds at 20 seconds after turning “ON” the backup switch, the outdoor unit main PCB is normal but the fan motor is defective.

If the voltage is not detected, the outdoor unit main PCB is defective but the fan motor is normal.

Note (1) The voltage is output 3 times repeatedly. If it is not detected, the indoor unit displays the error message.

Models SCM71, 80

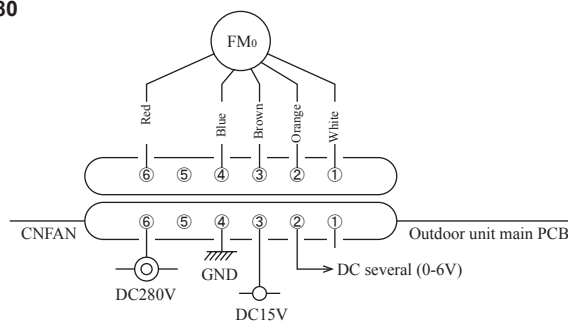

| Measuring point | Resistance when normal |
|-----------------|------------------------|
| ⑥ - ④ | DC280V |
| ③ - ④ | DC15V |
| ② - ④ | DC several V(0-6V) |

(ii) Fan motor resistance check

Models SCM71, 80

| Measuring point | Resistance when normal |
|-------------------|------------------------|
| ⑥-④(Red - Blue) | 20 MΩ or higher |
| ③-④(Brown - Blue) | 20 kΩ or higher |

Notes(1) Remove the fan motor and measure it without power connected to it.

- (2) If the measured value is below the value when the motor is normal, it means that the fan motor is faulty.

2.2 FDTC, FDUM and FDE series

2.2.1 Diagnosing of microcomputer circuit

(1) Selfdiagnosis function

(a) Check indicator table

Whether a failure exists or not on the indoor unit and outdoor unit can be know by the contents of remote control error code, indoor/outdoor unit green LED (power pilot lamp and microcomputer normality pilot lamp) or red LED (check pilot lamp).

(i) Indoor unit

| Remote control | Indoor control PCB | | | Outdoor main PCB | Location of trouble | Description of trouble | Repair method | Reference page |
|---------------------|--------------------|------------------|----------------|--|--|---|---------------|--------------------------------------|
| | Error code | Red LED | Red LED | Green LED (1) | | | | |
| No-indication | Stays OFF | Stays OFF | Keeps flashing | Stays OFF | — | • Normal operation | — | — |
| | | Stays OFF | Stays OFF | Stays OFF | Indoor unit power source | • Power OFF, broken wire/blown fuse, broken transformer wire | Repair | 119 |
| | | * 3-time flash | Keeps flashing | Stays OFF | Remote control wires | • Poor connection, breakage of remote control wire * For wire breaking at power ON, the LED is OFF. | Repair | 120 |
| | | | Remote control | • Defective remote control PCB | Replacement of remote control | | | |
| WAIT or INSPECT I/U | Stays OFF | Keeps flashing | Stays OFF | Indoor-outdoor units connection wire | • Poor connection, breakage of indoor-outdoor units connection wire | Repair | 121-125 | |
| | | | | Remote control | • Improper setting of master and slave by remote control | | | |
| E1 | Stays OFF | * Keeps flashing | Stays OFF | Remote control wires (Noise) | • Poor connection of remote control signal wire (White) * For wire breaking at power ON, the LED is OFF | Repair | 127 | |
| | | | | Remote control indoor unit control PCB | * Defective remote control or indoor unit control PCB (defective communication circuit)? | | | Replacement of remote control or PCB |
| E5 | 2-time flash | Keeps flashing | 6-time flash | Indoor-outdoor units connection wire | • Poor connection of wire between indoor-outdoor units during operation (disconnection, loose connection) | Repair | 128 | |
| | | | | (Noise) | • CPU-runaway on outdoor unit control PCB | | | |
| | | | | Outdoor unit control PCB | * Occurrence of defective outdoor unit control PCB on the way of power source (defective communication circuit)? | | | Power reset or Repair of PCB |
| | | | | Fuse | • Blown fuse | | | Replacement of PCB |
| E6 | 1-time flash | Keeps flashing | Stays OFF | Indoor heat exchanger temperature sensor | • Defective indoor heat exchanger temperature sensor (defective element, broken wire, short-circuit) | Replacement, repair of temperature sensor | 129 | |
| | | | | Indoor unit control PCB | * Defective indoor unit control PCB (Defective temperature sensor input circuit)? | | | Replacement of PCB |
| E7 | 1-time flash | Keeps flashing | Stays OFF | Indoor return air temperature sensor | • Defective indoor return air temperature sensor (defective element, broken wire, short-circuit) | Replacement, repair of temperature sensor | 130 | |
| | | | | Indoor control PCB | * Defective indoor unit control PCB (Defective temperature sensor input circuit)? | | | Replacement of PCB |
| E8 | 1-time flash | Keeps flashing | Stays OFF | Installation or operating condition | • Heating over-load (Anomalously high indoor heat exchanger temperature) | Repair | 131 | |
| | | | | Indoor heat exchanger temperature sensor | • Defective indoor heat exchanger temperature sensor (short-circuit) | | | |
| E9 | 1-time flash | Keeps flashing | Stays OFF | Indoor unit control PCB | * Defective indoor unit control PCB (Defective temperature sensor input circuit)? | Replacement of PCB | 132 | |
| | | | | Option | • Defective option parts (At optional anomalous input setting) | | | |
| E10 | Stays OFF | Keeps flashing | Stays OFF | Number of connected indoor units | • When multi-unit control by remote control is performed, the number of units is over | Repair | 133 | |
| E11 | Keeps flashing | Keeps flashing | Stays OFF | Address setting error | • Address setting error of indoor units | Repair | 134 | |
| E16 | 1-time flash | Keeps flashing | Stays OFF | Fan motor | • Defective fan motor | Replacement, repair | 135 | |
| | | | | Indoor unit control PCB | • Defective indoor unit control PCB | | | Replacement |
| E19 | 1-time flash | Keeps flashing | Stays OFF | Indoor unit control PCB | • Improper operation mode setting | Repair | 136 | |
| E20 | 1-time flash | Keeps flashing | Stays OFF | Fan motor | • Indoor fan motor rotation speed anomaly | Replacement, repair | 137 | |
| | | | | Indoor unit power PCB | • Defective indoor unit power PCB | | | Replacement |
| E28 | Stays OFF | Keeps flashing | Stays OFF | Remote control temperature sensor | • Broken wire of remote control temperature sensor | Repair | 138 | |

Note (1) Normal indicator lamp (Indoor unit: Green) extinguishes (or lights continuously) only when CPU is anomalous. It keeps flashing in any trouble other than anomalous CPU.

(2) * mark in the description of trouble means that, in ordinary diagnosis, it cannot identify the cause definitely, and, if the trouble is repaired by replacing the part, it is judged consequently that the replaced part was defective.

(ii) Outdoor unit

| Remote control | | Indoor control PCB | | Outdoor main PCB | Location of trouble | Description of trouble | Repair method | Reference page |
|----------------|----------------|--------------------|----------------|------------------|--|---|---|----------------|
| Error code | Red LED | Red LED | Green LED | Red LED | | | | |
| E35 | Keeps flashing | Stays OFF | Keeps flashing | 2-time flash | Installation, operation status | • Higher outdoor heat exchanger temperature | Repair | 139 |
| | | | | | Outdoor heat exchanger temperature sensor | • Defective outdoor heat exchanger temperature sensor | Replacement, repair of temperature sensor | |
| | | | | | Outdoor unit main PCB | *• Defective outdoor unit main PCB (Defective temperature sensor input circuit)? | Replacement of PCB | |
| E36 | Keeps flashing | Stays OFF | Keeps flashing | 5-time flash | Installation, operation status | • Higher discharge temperature | Repair | 140 |
| | | | | | Discharge pipe temperature sensor | • Defective discharge pipe temperature sensor | Replacement, repair of temperature sensor | |
| | | | | | Outdoor unit main PCB | *• Defective outdoor unit main PCB (Defective temperature sensor input circuit)? | Replacement of PCB | |
| E37 | Keeps flashing | Stays OFF | Keeps flashing | 8-time flash | Outdoor heat exchanger temperature sensor | • Defective outdoor heat exchanger temperature sensor, broken wire or poor connector connection | Replacement, repair of temperature sensor | 141 |
| | | | | | Outdoor unit main PCB | *• Defective outdoor unit main PCB (Defective temperature sensor input circuit)? | Replacement of PCB | |
| E38 | Keeps flashing | Stays OFF | Keeps flashing | 8-time flash | Outdoor air temperature sensor | • Defective outdoor air temperature sensor, broken wire or poor connector connection | Replacement, repair of temperature sensor | 142 |
| | | | | | Outdoor unit main PCB | *• Defective outdoor unit main PCB (Defective temperature sensor input circuit)? | Replacement of PCB | |
| E39 | Keeps flashing | Stays OFF | Keeps flashing | 8-time flash | Discharge pipe temperature sensor | • Defective discharge pipe temperature sensor, broken wire or poor connector connection | Replacement, repair of temperature sensor | 143 |
| | | | | | Outdoor unit main PCB | *• Defective outdoor unit main PCB (Defective temperature sensor input circuit)? | Replacement of PCB | |
| E40 | Keeps flashing | Stays OFF | Keeps flashing | 4-time flash | Installation, operation status | • Service valve (gas side) closing operation | Replacement | 144 |
| E42 | Keeps flashing | Stays OFF | Keeps flashing | 1-time flash | Outdoor unit main PCB, compressor | • Current cut (Anomalous compressor over-current) | Replacement of PCB | 145 • 146 |
| | | | | | Installation, operation status | • Service valve closing operation | Repair | |
| E45 | Keeps flashing | Stays OFF | Keeps flashing | 4-time flash | Outdoor unit main PCB | • Anomalous outdoor unit main PCB communication | Replacement of PCB | 147 |
| | | | | | Outdoor unit sub PCB | • Anomalous outdoor unit sub PCB communication | | |
| E47 | Keeps flashing | Stays OFF | Keeps flashing | 2-time flash | Outdoor unit sub PCB | • Defective active filter | Repair PCB replacement | 148 |
| E48 | Keeps flashing | Stays OFF | Keeps flashing | ON | Fan motor | • Defective fan motor | Replacement | 149 |
| | | | | | Outdoor unit main PCB | • Defective outdoor unit main PCB | | |
| E51 | Keeps flashing | Stays OFF | Keeps flashing | 1-time flash | Power transistor error (outdoor unit main PCB) | • Power transistor error | Replacement of PCB | 150 |
| E53 | Keeps flashing | Stays OFF | Keeps flashing | 8-time flash | Outdoor suction pipe sensor | • Defective suction pipe temperature sensor, broken wire or poor connector connection | Replacement, repair of temperature sensor | 151 |
| | | | | | Outdoor unit sub PCB | • Defective outdoor unit sub PCB (Defective temperature sensor input circuit)? | Replacement of PCB | |
| E57 | Keeps flashing | Stays OFF | Keeps flashing | 2-time flash | Operation status | • Shortage in refrigerant quantity | Repair | 152 |
| | | | | | Installation status | • Service valve closing operation | Service valve opening check | |
| E58 | Keeps flashing | Stays OFF | Keeps flashing | 3-time flash | • Overload operation • Overcharge • Compressor locking | • Current safe stop | Replacement | 153 |
| E59 | Keeps flashing | Stays OFF | Keeps flashing | 2-time flash | Compressor, outdoor unit main PCB | • Anomalous compressor startup | Replacement | 154 |
| E60 | Keeps flashing | Stays OFF | Keeps flashing | 7-time flash | Compressor | • Anomalous compressor rotor lock | Replacement | 155 |

Note (1) * mark in the Description of trouble means that, in ordinary diagnosis, it cannot identify the cause definitely, and, if the trouble is repaired by replacing the part, it is judged consequently that the replaced part was defective.

(iii) Display sequence of error codes or inspection indicator lamps

■ Occurrence of one kind of error



Displays are shown respectively according to errors.

■ Occurrence of plural kinds of error

| Section | Category of display |
|------------------------------------|---|
| Error code on remote control | <ul style="list-style-type: none"> • Displays the error of higher priority (When plural errors are persisting) |
| Red LED on indoor unit control PCB | |
| Red LED on outdoor unit main PCB | |

E1 E5 E10 > E3 > E60

■ Error detecting timing

| Section | Error description | Error code | Error detecting timing |
|---------|---|--|---|
| Indoor | Drain trouble (Float switch activated) | <i>E9</i> | Whenever float switch is activated after 30 second had past since power ON. |
| | Communication error at initial operation | “  WAIT  ” | No communication between indoor and outdoor units is established at initial operation. |
| | Remote control communication circuit error | <i>E1</i> | Communication between indoor unit and remote control is interrupted for mote than 2 minutes continuously after initial communication was established. |
| | Communication error during operation | <i>E5</i> | Communication between indoor and outdoor units is interrupted for mote than 2 minutes continuously after initial communication was established. |
| | Excessive number of connected indoor units by controlling with one remote control | <i>E10</i> | Whenever excessively connected indoor units is detected after power ON. |
| | Return air temperature sensor anomaly | <i>E7</i> | -50°C or lower is detected for 5 seconds continuously within 60 minutes after initial detection of this anomalous temperature. |
| | Indoor heat exchanger temperature sensor anomaly | <i>E6</i> | -50°C or lower is detected for 5 seconds continuously within 60 minutes after initial detection of this anomalous temperature. Or 70°C or higher is detected for 5 seconds continuously. |
| Outdoor | Outdoor air temperature sensor anomaly | <i>E38</i> | -55°C or lower is detected for 5 seconds continuously 3 times within 40 minutes after initial detection of this anomalous sensor. Or -55°C or higher is detected for 5 seconds continuously within 20 seconds after power ON. |
| | Outdoor heat exchanger temperature sensor anomaly | <i>E37</i> | -55°C or lower is detected for 5 seconds continuously 3 times within 40 minutes after initial detection of this anomalous sensor. Or -55°C or lower is detected for 5 seconds continuously within 20 seconds after power ON. |
| | Discharge pipe temperature sensor anomaly | <i>E39</i> | -25°C or lower is detected for 5 seconds continuously 3 times within 40 minutes after initial detection of this anomalous sensor. |
| | Suction pipe temperature sensor anomaly | <i>E53</i> | -55°C or lower is detected for 5 seconds continuously 3 times within 40 minutes after initial detection of this anomalous sensor. Or -55°C or higher is detected for 5 seconds continuously within 20 seconds after power ON. |

■ **Error log and reset**

| Error indicator | Memorized error log | Reset |
|------------------------------------|--|---|
| Remote control display | • Higher priority error is memorized. | • Stop the unit by pressing the ON/OFF switch of remote control. • If the unit has recovered from anomaly, it can be operated. |
| Red LED on indoor unit control PCB | • Not memorized. | |
| Red LED on outdoor unit main PCB | • Memorizes a mode of higher priority. | |

■ **Resetting the error log**

- Resetting the memorized error log in the remote control

Holding down “CHECK” button, press “TIMER” button to reset the error log memorized in the remote control.

- Resetting the memorized error log

The remote control transmits error log erase command to the indoor unit when “VENTI” button is pressed while holding down “CHECK” button.

Receiving the command, the indoor unit erase the log and answer the status of no error.

(2) **Troubleshooting procedure**

When any trouble has occurred, inspect as follows. Details of respective inspection method will be described on later pages.

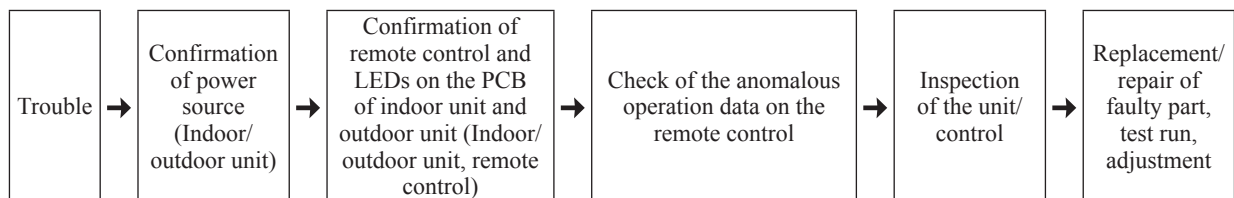

(3) **Troubleshooting at the indoor unit**

With the troubleshooting, find out any defective part by checking the voltage (AC, DC), resistance, etc. at respective connectors at around the indoor unit PCB, according to the inspection display or operation status of unit (the compressor does not run, fan does not run, the 4-way valve does not switch, etc.), and replace or repair in the unit of following part.

(a) **Replacement part related to indoor unit PCB's**

Control PCB, power PCB, temperature sensor (return air, indoor heat exchanger), remote control and fuse

Note (1) With regard to parts of high voltage circuits and refrigeration cycle, judge it according to ordinary inspection methods.

(b) **Instruction of how to replace indoor unit control PCB**

SAFETY PRECAUTIONS

- Read the "SAFETY PRECAUTIONS" carefully first of all and then strictly follow it during the replacement in order to protect yourself.
- The precautionary items mentioned below are distinguished into two levels, WARNING and CAUTION. Both mentions the important items to protect your health and safety so strictly follow them by any means.

⚠ WARNING Wrong installation would cause serious consequences such as injuries or death.
⚠ CAUTION Wrong installation might cause serious consequences depending on circumstances.

- After completing the replacement, do commissioning to confirm there are no anomaly.

⚠ WARNING

- Replacement should be performed by the specialist.
If you replace the PCB by yourself, it may lead to serious trouble such as electric shock or fire.
- Replace the PCB correctly according to these instructions.
Improper replacement may cause electric shock or fire.
- Shut off the power before electrical wiring work. Start the work after elapsing 1 minutes or more from power pff.
Replacement during the applying the current would cause the electric shock, unit failure or improper running.
It would cause the damage of connected equipment such as fan motor,etc.
- Fasten the wiring to the terminal securely, and hold the cable securely so as not to apply unexpected stress on the terminal.
Loose connections or hold could result in abnormal heat generation or fire.
- Check the connection of wiring to PCB correctly before turning on the power, after replacement.
Defectiveness of replacement may cause electric shock or fire.

⚠ CAUTION

- In connecting connector onto the PCB, connect not to deform the PCB. It may cause breakage or malfunction.
- Insert connector securely, and hook stopper. It may cause fire or improper running.
- Bundle the cables together so as not to be pinched or be tensioned. It may cause malfunction or electric shock for disconnection or deformation.

(i) **FDTC series**

PSC012D050 

Replace and set up the PCB according to this instruction.

- 1) Set to an appropriate address and function using switch on PCB.
Select the same setting with the removed PCB.

| Item | Switch | Content of control | |
|----------|--------|---|--------------------------------------|
| Address | SW2 | Plural indoor units control by 1 remote control | |
| Test run | SW7-1 | OFF | Normal |
| | | ON | Operation check/drain motor test run |

- 2) Set to an appropriate capacity using the model selector switch(SW6).
Select the same capacity with the PCB removed from the unit.

| SW6 | -1 | -2 | -3 | -4 |
|------|-----|-----|-----|-----|
| 25VH | ON | OFF | OFF | OFF |
| 35VH | OFF | ON | OFF | OFF |
| 50VH | ON | OFF | ON | OFF |
| 60VH | ON | ON | ON | OFF |

SW6

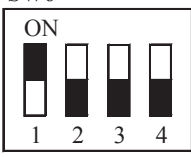

Example setting for 25VH

- 3) Replace the PCB

- a) Unscrew terminal (Arrow A) of the "E1" wiring (yellow/green) that is connected to PCB.
- b) Replace the PCB only after all the wirings connected to the connector are removed.
- c) Fix the board such that it will not pinch any of the wires.
- d) Switch setting must be same setting as that of the removed PCB.
- e) Reconnect the wirings to the PCB. Wiring connector color should match with the color of connector of the PCB.
- f) Screw back the terminal (Arrow A) of the "E1" wiring, that was removed in a).

- 4) Control PCB

Parts mounting are different by the kind of PCB.

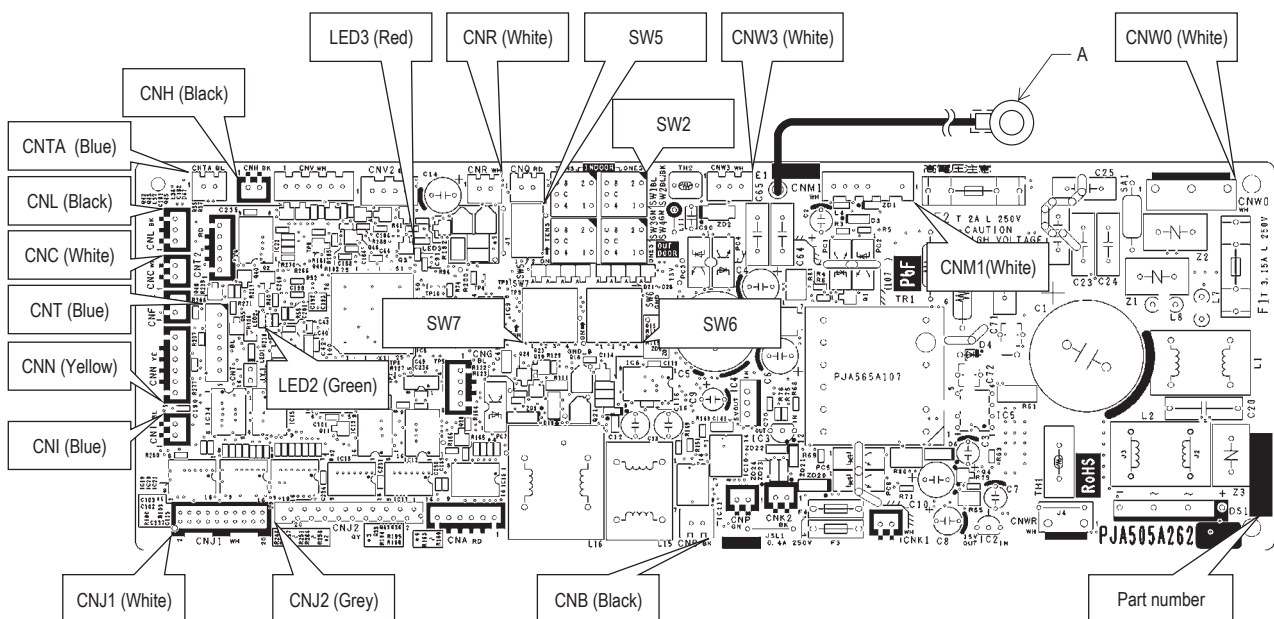

(ii) Models FDUM, FDE series

1) Control PCB

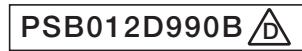

Replace and set up the PCB according to this instruction.

- a) Set to an appropriate address and function using switch on PCB.
Select the same setting with the removed PCB.

| item | switch | Content of control | |
|----------|--------|---|---|
| Address | SW2 | Plural indoor units control by 1 remote control | |
| Test run | SW7-1 | — | Normal |
| | | ○ | Operation check/drain pump motor test run |

○:ON —:OFF

- b) Set to an appropriate capacity using the model selector switch(SW6).
Select the same capacity with the PCB removed from the unit.

| SW6 | -1 | -2 | -3 | -4 |
|------|----|-----|----|-----|
| 50VH | ON | OFF | ON | OFF |

Example setting for 50VH

- c) Replace the PCB

- ① Exchange PCB after detaching all connectors connected with the PCB.
- ② Fix the PCB so as not to pitch the wiring.
- ③ Connect connectors to the PCB. Match the wiring connector to the connector color on the PCB and connect it.

- d) Control PCB

Parts mounting are different by the kind of PCB.

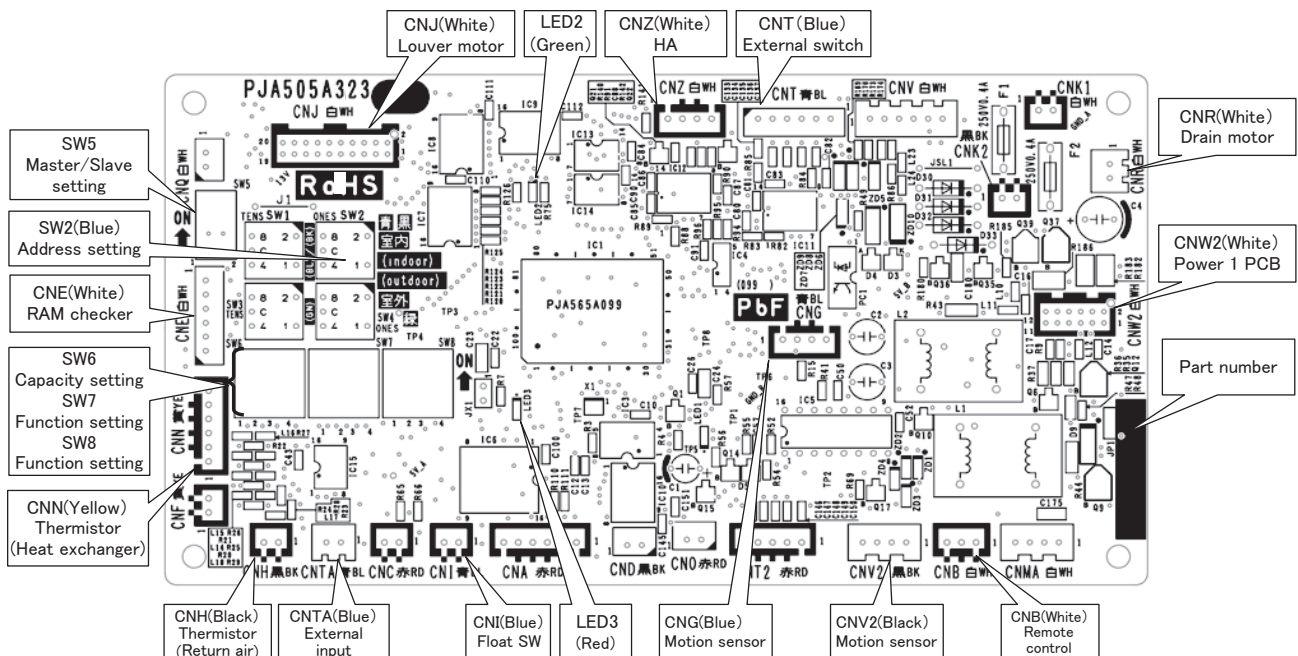

2) Power PCB

This PCB is a general PCB. Replace the PCB according to this instruction.

a) Replace the PCB

- ① Unscrew terminal of the wiring(yellow/green) connected to terminal block (CNW0) from the box.
- ② Replace the PCB only after all the wirings connected to the connector are removed.
- ③ Fix the board such that it will not pinch any of the wires.
- ④ Reconnect the wirings to the PCB. Wiring connector color should match with the color of connector of the PCB.
- ⑤ Screw back the terminal of wiring, that was removed in ①.

b) Power PCB

Parts mounting are different by the kind of PCB.

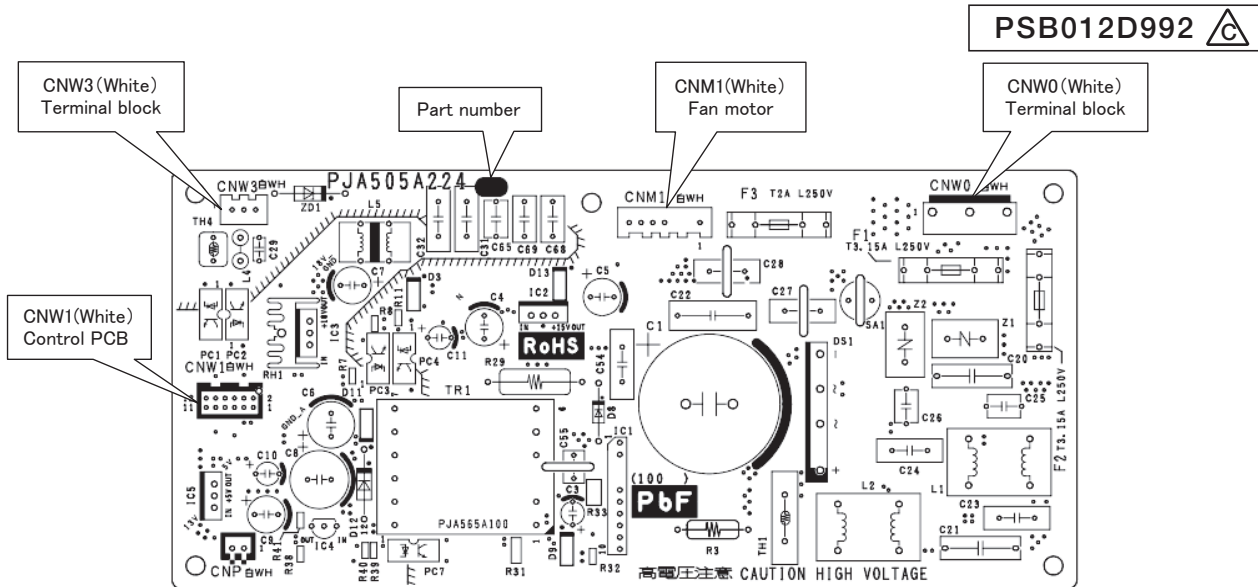

●DIP switch setting list

| Switch | Description | | Default setting | | Remark |
|--------|---|-------------------------|-----------------|---------|--------------|
| SW2 | Address No. setting at plural indoor units control by 1 R/C | | 0 | | 0-F |
| SW6-1 | Model selection | | As per model | | See table 1. |
| SW6-2 | | | | | |
| SW6-3 | | | | | |
| SW6-4 | | | | | |
| SW7-1 | Test run, drain motor | Normal*/Test run | OFF | Normal | |
| SW7-2 | Reserved | | OFF | | Keep OFF |
| SW7-3 | Reserved | | OFF | | Keep OFF |
| SW7-4 | Reserved | | OFF | | Keep OFF |
| SW8-1 | Anti-freeze control | Valid/Invalid* | OFF | Invalid | |
| SW8-2 | Reserved | | OFF | | Keep OFF |
| SW8-3 | Reserved | | OFF | | Keep OFF |
| SW8-4 | Reserved | | OFF | | Keep OFF |
| JSL1 | Superlink terminal spare | Normal*/switch to spare | With | | |

Note(1) : SW8 : FDE only

* Default setting

Table 1: Indoor unit model selection with SW6-1-SW6-4

| Switch | 25VH | 35VH | 50VH | 60VH |
|--------|------|------|------|------|
| SW6-1 | ON | OFF | ON | ON |
| SW6-2 | OFF | ON | OFF | ON |
| SW6-3 | OFF | OFF | ON | ON |
| SW6-4 | OFF | OFF | OFF | OFF |

(4) Troubleshooting at the outdoor unit

When troubleshooting the outdoor unit, firstly assess the overview of malfunction and try to presume the cause and the faulty part by checking the error code displayed on the remote control and then proceed further inspection and remedy it.

Self-diagnosis system by microcomputer on indoor unit PCB can assist to find the cause of malfunction smoothly by making a diagnosis of not only the anomaly of microcomputer, but also the anomaly in power source system, installation space, overload resulting from improper charging amount of refrigerant and etc.

Unless the power is reset, the error log is saved in memory.

After automatical recovering from malfunction, if any another error mode which has a higher priority than the previous error saved in memory occurs, it is overwritten in memory and is displayed.

[Reset of power source]

Be sure to avoid electrical shock, when replacing or checking the outdoor unit control PCB, because some voltage is still retained in the electrolytic capacitor on the PCB even after shutting down the power source to the outdoor unit.

Be sure to start repairing work and reconfirming that voltage has been discharged sufficiently by measuring the voltage (DC) between both terminals of electrolytic capacitor (C58).

(Measurement of voltage may be disturbed by the moisture-proof coating. In such case, remove the coating and measure it by taking care of avoiding electrical shock.)

(a) Module of part to be replaced for outdoor unit control

Outdoor unit PCB, Temperature sensor (of outdoor heat exchanger, discharge pipe, outdoor air), Fuses (for power source and PCB) and Reactor.

(5) Check of anomalous operation data with the remote control**(a) In case of RC-EX3A remote control**

[Operating procedure]

① On the TOP screen, touch the buttons in the order of “Menu” → “Service setting” → “Service & Maintenance” → “Service password” → “Set” → “Error display” → “Error history”.

② When only one indoor unit is connected to the remote control, followings will be displayed.

1) When there is any anomaly: “Loading. Wait a while” is displayed, followed by the operation data at the occurrence of anomaly. Contents of display

- Error code
- Number and data item

2) When there is no anomaly: “No anomaly” is displayed, and this mode is terminated.

③ When two or more indoor units are connected to the remote control, followings will be displayed.

1) When there is any anomaly: If the unit having anomaly is selected on the “Select IU” screen, “Loading. Wait a while” is displayed, followed by the operation data at the occurrence of anomaly.

Contents of display

- Indoor unit No.
- Error code
- Number and data item

2) When there is no anomaly: “No anomaly” is displayed, and this mode is terminated.

Note (1) When the number of connected units cannot be shown in a page, select “Next”.

④ If you press [RUN/STOP] button, the display returns to the TOP screen.

◎ **If you touch “Back” button on the way of setting, the display returns to the last precious screen.**

Note (1) When two remote controls are used to control indoor units, the check of anomaly operation data can be made on the master remote control only. (It cannot be operated from the slave remote control.)

■ Anomaly operation data (Corresponding data may not be provided depending on models. Such items will not be displayed.)

| Number | Data Item |
|--------|--|
| 01 | ☼ (Operation Mode) |
| 02 | SET TEMP. ℃ (Set Temperature) |
| 03 | RETURN AIR. ℃ (Return Air Temperature) |
| 04 | SENSOR. ℃ (Remote Control Temperature) |
| 05 | THI-R1. ℃ (Indoor Heat Exchanger Temperature / U Bend) |
| 06 | THI-R2. ℃ (Indoor Heat Exchanger Temperature /Capillary) |
| 07 | THI-R3. ℃ (Indoor Heat Exchanger Temperature /Gas Header) |
| 08 | I/U FANSPEED (Indoor Unit Fan Speed) |
| 09 | DEMAND. Hz (Frequency Requirements) |
| 10 | ANSWER. Hz (Response Frequency) |
| 11 | I/U EEV. P (Pulse of Indoor Unit Expansion Value) |
| 12 | TOTAL I/U RUN. H (Total Running Hours of The Indoor Unit) |
| 13 | SUPPLY AIR. ℃ (Supply Air Temperature) |
| 21 | OUTDOOR. ℃ (Outdoor Air Temperature) |
| 22 | THO-R1. ℃ (Outdoor Heat Exchanger Temperature) |
| 23 | THO-R2. ℃ (Outdoor Heat Exchanger Temperature) |
| 24 | COMP. Hz (Compressor Frequency) |
| 25 | HP. MPa (High Pressure) |
| 26 | LP. MPa (Low Pressure) |
| 27 | Td. ℃ (Discharge Pipe Temperature) |
| 28 | COMP BOTTOM. ℃ (Comp Bottom Temperature) |
| 29 | CT. AMP (Current) |
| 30 | TARGET SH. ℃ (Target Super Heat) |
| 31 | SH. ℃ (Super Heat) |
| 32 | TDSH. ℃ (Discharge Pipe Super Heat) |
| 33 | PROTECTION No. (Protection State No. of The Compressor) |
| 34 | O/U FANSPEED (Outdoor Unit Fan Speed) |
| 35 | 63H1 (63H1 On/Off) |
| 36 | DEFROST (Defrost Control On/Off) |
| 37 | TOTAL COMP RUN. H (Total Running Hours of The Compressor) |
| 38 | O/U EEV1. P (Pulse of The Outdoor Unit Expansion Valve EEVC) |
| 39 | O/U EEV2. P (Pulse of The Outdoor Unit Expansion Valve EEVH) |

●33 Details of compressor protection status No.

| No. | Contents of display |
|------|--|
| "0" | Normal |
| "1" | Discharge pipe temperature protection control |
| "2" | Discharge pipe temperature anomaly |
| "3" | Current safe control of inverter primary current |
| "4" | High pressure protection control |
| "5" | High pressure anomaly |
| "6" | Low pressure protection control |
| "7" | Low pressure anomaly |
| "8" | Anti-frost prevention control |
| "9" | Current cut |
| "10" | Power transistor protection control |
| "11" | Power transistor anomaly (Overheat) |
| "12" | Compression ratio control |
| "13" | Spare |
| "14" | Dewing prevention control |
| "15" | Current safe control of inverter secondary current |
| "16" | Stop by compressor rotor lock |
| "17" | Stop by compressor startup failure |

Note(1) Operation data display on the remote control.

• Data are displayed until canceling the protection control.

• In case of multiple protections controlled, only the younger No. is displayed.

Note(2) Common item.

① In heating mode.

During protection control by the command signal for reducing compressor frequency from indoor unit, No. "4" is displayed.

② In cooling and dehumidifying mode.

During protection control by the command signal for reducing compressor frequency from indoor unit, No. "8" is displayed.

(b) In case of RC-E5 remote control

Operation data can be checked with remote control unit operation.

- ① Press the **CHECK** button.
The display change “OPER DATA ▾”
- ② Press the **(SET)** button while “OPER DATA ▾” is displayed.
- ③ When only one indoor unit is connected to remote control, “DATA LOADING” is displayed (blinking indication during data loading).
Next, operation data of the indoor unit will be displayed. Skip to step ⑦.
- ④ When plural indoor units is connected, the smallest address number of indoor unit among all connected indoor unit is displayed.
[Example]:
“SELECT I/U” (blinking 1 seconds) → “I/U000 ▲” blinking.
- ⑤ Select the indoor unit number you would like to have data displayed with the **▲ ▼** button.
- ⑥ Determine the indoor unit number with the **(SET)** button.
(The indoor unit number changes from blinking indication to continuous indication)
“I/U000” (The address of selected indoor unit is blinking for 2 seconds.)
↓
“DATA LOADING” (A blinking indication appears while data loaded.) Next, the operation data of the indoor unit is indicated.
- ⑦ Upon operation of the **▲ ▼** button, the current operation data is displayed in order from data number 01. The items displayed are in the above table.

*Depending on models, the items that do not have corresponding data are not displayed.

- ⑧ To display the data of a different indoor unit, press the **AIR CON No.** button, which allows you to go back to the indoor unit selection screen.
- ⑨ Pressing the **(ON/OFF)** button will stop displaying data.
Pressing the **(RESET)** button during remote control unit operation will undo your last operation and allow you to go back to the previous screen.
⊙ If two (2) remote controls are connected to one (1) inside unit, only the master control is available for trial operation and confirmation of operation data. (The slave remote control is not available.)

| Number | | Data Item |
|--------|----------------|---|
| 01 | | (Operation Mode) |
| 02 | SET TEMP | (Set Temperature) |
| 03 | RETURN AIR | (Return Air Temperature) |
| 04 | SENSOR | (Remote Control Temperature) |
| 05 | THI-R1 | (Indoor Heat Exchanger Temperature Sensor / U Bend) |
| 06 | THI-R2 | (Indoor Heat Exchanger Temperature Sensor / Capillary) |
| 07 | THI-R3 | (Indoor Heat Exchanger Temperature Sensor / Gas Header) |
| 08 | I/U FANSPEED | (Indoor Unit Fan Speed) |
| 09 | DEMAND | (Frequency Requirements) |
| 10 | ANSWER | (Response Frequency) |
| 11 | I/U EEV | (Pulse of Indoor Unit Expansion Value) |
| 12 | TOTAL I/U RUN | (Total Running Hours of The Indoor Unit) |
| 21 | OUTDOOR | (Outdoor Air Temperature) |
| 22 | THO-R1 | (Outdoor Heat Exchanger Temperature) |
| 23 | THO-R2 | (Outdoor Heat Exchanger Temperature) |
| 24 | COMP | (Compressor Frequency) |
| 25 | HP | (High Pressure) |
| 26 | LP | (Low Pressure) |
| 27 | Td | (Discharge Pipe Temperature) |
| 28 | COMP BOTTOM | (Comp Bottom Temperature) |
| 29 | CT | (Current) |
| 30 | TARGET SH | (Target Super Heat) |
| 31 | SH | (Super Heat) |
| 32 | TDSH | (Discharge Pipe Super Heat) |
| 33 | PROTECTION No. | (Protection State No. of The Compressor) |
| 34 | O/U FANSPEED | (Outdoor Unit Fan Speed) |
| 35 | 63H1 | (63H1 On/Off) |
| 36 | DEFROST | (Defrost Control On/Off) |
| 37 | TOTAL COMP RUN | (Total Running Hours of The Compressor) |
| 38 | O/U EEV1 | (Pulse of The Outdoor Unit Expansion Valve EEVC) |
| 39 | O/U EEV2 | (Pulse of The Outdoor Unit Expansion Valve EEVH) |

●33 Details of compressor protection status No.

| No. | Contents of display |
|------|--|
| "0" | Normal |
| "1" | Discharge pipe temperature protection control |
| "2" | Discharge pipe temperature anomaly |
| "3" | Current safe control of inverter primary current |
| "4" | High pressure protection control |
| "5" | High pressure anomaly |
| "6" | Low pressure protection control |
| "7" | Low pressure anomaly |
| "8" | Anti-frost prevention control |
| "9" | Current cut |
| "10" | Power transistor protection control |
| "11" | Power transistor anomaly (Overheat) |
| "12" | Compression ratio control |
| "13" | Spare |
| "14" | Dewing prevention control |
| "15" | Current safe control of inverter secondary current |
| "16" | Stop by compressor rotor lock |
| "17" | Stop by compressor startup failure |

- Note(1) Operation data display on the remote control.
•Data are displayed until canceling the protection control.
•In case of multiple protections controlled, only the younger No. is displayed.
- Note(2) Common item.
① In heating mode.
During protection control by the command signal for reducing compressor frequency from indoor unit, No. "4" is displayed.
② In cooling and dehumidifying mode.
During protection control by the command signal for reducing compressor frequency from indoor unit, No. "8" is displayed.

(6) Inverter checker for diagnosis of inverter output

● Checking method

- (a) Setup procedure of checker.
 - (i) Power OFF (Turn off the breaker).
 - (ii) Remove the terminal cover of compressor and disconnect the wires (U, V, W) from compressor.
 - (iii) Connect the wires U (Red), V (White) and W (Black) of the checker to the terminal of disconnected wires (U, V, W) from compressor respectively.
- (b) Operation for judgment.
 - (i) Power ON and start check operation on cooling or heating mode.
 - (ii) Check ON/OFF status of 6 LED's on the checker.
 - (iii) Judge the PCB by ON/OFF status of 6 LED's on the checker.

| ON/OFF status of LED | If all of LED are ON/OFF according to following pattern | If all of LED stay OFF or some of LED are ON/OFF |
|----------------------|---|--|
| Outdoor main PCB | Normal | Anomalous |

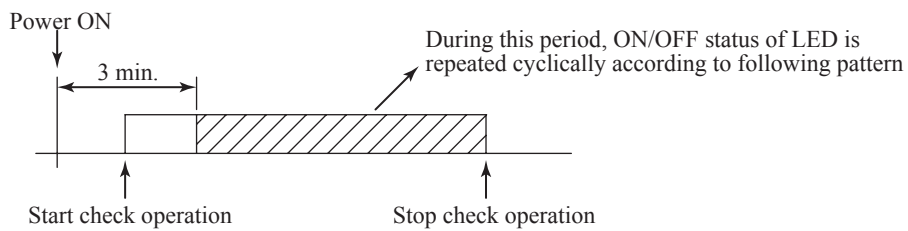

- (iv) Stop check operation within about 2minutes after starting check operation.

<Inverter Checker>

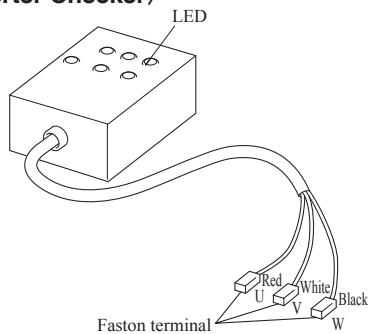

LED ON/OFF pattern

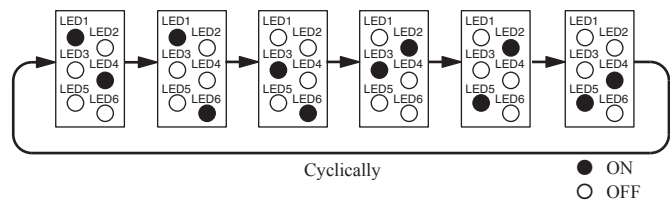

Connect to the terminal of the wires which are disconnected from compressor.

(7) Outdoor unit inspection points

- See page 98 to 99.

2.2.2 Troubleshooting flow

(1) List of troubles

| Remote control display | Description of trouble | Reference page |
|------------------------|--|----------------|
| None | Operates but does not cool | 112 |
| None | Operates but does not heat | 113 |
| None | Earth leakage breaker activated | 114 |
| None | Excessive noise/vibration | 115–117 |
| None | Louver motor failure (FDTC and FDE only) | 118 |
| None | Power source system error (Power source to indoor unit control PCB) | 119 |
| None | Power source system error (Power source to remote control) | 120 |
| INSPECT I/U | INSPECT I/U (When 1 or 2 remote controls are connected) | 121 |
| INSPECT I/U | INSPECT I/U (Connection of 3 units or more remote controls) | 122 |
| 🔊WAIT🔊 | Communication error at initial operation | 123–125 |
| None | No display | 126 |
| E1 | Remote control communication circuit error | 127 |
| E5 | Communication error during operation | 128 |
| E6 | Indoor heat exchanger temperature sensor anomaly | 129 |
| E7 | Return air temperature sensor anomaly | 130 |
| E8 | Heating overload operation | 131 |
| E9 | Drain trouble (FDTC and FDUM only) | 132 |
| E10 | Excessive number of connected indoor units (more than 17 units) by controlling with one remote control | 133 |
| E11 | Address setting error of indoor units | 134 |
| E16 | Indoor fan motor anomaly | 135 |
| E19 | Indoor unit operation check, drain pump motor check setting error | 136 |
| E20 | Indoor fan motor rotation speed anomaly | 137 |
| E28 | Remote control temperature sensor anomaly | 138 |
| E35 | Cooling high pressure operation | 139 |
| E36 | Discharge pipe temperature error | 140 |
| E37 | Outdoor heat exchanger temperature sensor anomaly | 141 |
| E38 | Outdoor air temperature sensor anomaly | 142 |
| E39 | Discharge pipe temperature sensor anomaly | 143 |
| E40 | Service valve (gas side) closing operation | 144 |
| E42 | Current cut | 145 · 146 |
| E45 | Outdoor unit sub PCB communication error | 147 |
| E47 | Active filter voltage error | 148 |
| E48 | Outdoor fan motor anomaly | 149 |
| E51 | Power transistor anomaly | 150 |
| E53 | Suction pipe temperature sensor anomaly | 151 |
| E57 | Insufficient refrigerant amount or detection of service valve closure | 152 |
| E58 | Current safe stop | 153 |
| E59 | Compressor startup failure | 154 |
| E60 | Compressor rotor lock error | 155 |

(2) Troubleshooting

| | | | | |
|------------------------------------|---------|----------------|-----------|--|
| Error code Remote control: None | LED | Green | Red | Content Operates but does not cool |
| | Indoor | Keeps flashing | Stays OFF | |
| | Outdoor | — | Stays OFF | |

| |
|--|
| 1. Applicable model |
| All models |
| 2. Error detection method |
| |
| 3. Condition of error displayed |
| |
| 4. Presumable cause |
| <ul style="list-style-type: none"> • Poor compression of compressor • Faulty expansion valve operation |

| 5. Troubleshooting | | | | |
|---|--|----------------|---|--|
| <table border="1"> <thead> <tr> <th>Diagnosis</th> <th>Countermeasure</th> </tr> </thead> <tbody> <tr> <td> <p>Check the indoor fan operation. Check the temperature difference between return and supply air.</p> <pre> graph TD Start[Check indoor fan operation and temperature difference] --> D1{Is the temperature difference between return and supply air 10-20°C at cooling?} D1 -- YES --> D2{Does the heat load increase after installation?} D1 -- NO --> D3{Is the compressor operating?} D2 -- YES --> Box1[Mistake in model selection. Calculate heat load once more.] D2 -- NO --> CM1[It is normal. (This unit is designed to start in the soft start mode by detecting the under dome temperature of compressor when it restart after power reset.)] Box1 --> CM2[It is necessary to replace to higher capacity one or to install additional unit.] D3 -- NO --> D4{"⌚ WAIT ⌚" message is displayed (for 3 seconds) when performing cooling, defrosting and heating operations from the remote control.} D3 -- YES --> D5{Is the compressor rotation speed low?} D4 -- YES --> CM3[Compressor refrigerant oil protection control at starting is activated. For the contents of control, refer to the compressor start control of the microcomputer control functions.] D4 -- NO --> CM4[Compressor may be stopped by the error detection control. For the contents of control, refer to anomalous stop control by controlling compressor rotation speed of microcomputer control functions.] D5 -- NO --> CM5[Inspect the followings. • Minor clogging of filter • Minor clogging of heat exchanger • Minor short-circuit • Minor shortage of refrigerant amount • Poor compression of compressor] D5 -- YES --> Box2[Check which control "Determination control of compressor rotation speed" or "Protective control by controlling compressor rotation speed" is appropriate to this phenomenon.] Box2 --> D6{Are the temperature conditions of room and outdoor air close to the rated conditions? (1)} D6 -- YES --> CM6[Considering appropriate operation control, check suspicious points. Inspect the followings for reference. • Major clogging of filter • Major clogging of heat exchanger • Major short-circuit • Major shortage of refrigerant amount • Compressor protection ON • Indoor fan tap • Valid setting of silent mode] D6 -- NO --> End[The unit is operating normally but is operating under the control for protecting compressor or other respective parts.] </pre> <p>Note (1) Outdoor : 35°C, Indoor: 27°C</p> </td> <td> <p>It is normal. (This unit is designed to start in the soft start mode by detecting the under dome temperature of compressor when it restart after power reset.)</p> <p>It is necessary to replace to higher capacity one or to install additional unit.</p> <p>Compressor refrigerant oil protection control at starting is activated. For the contents of control, refer to the compressor start control of the microcomputer control functions.</p> <p>Compressor may be stopped by the error detection control. For the contents of control, refer to anomalous stop control by controlling compressor rotation speed of microcomputer control functions.</p> <p>Inspect the followings.</p> <ul style="list-style-type: none"> • Minor clogging of filter • Minor clogging of heat exchanger • Minor short-circuit • Minor shortage of refrigerant amount • Poor compression of compressor <p>Considering appropriate operation control, check suspicious points. Inspect the followings for reference.</p> <ul style="list-style-type: none"> • Major clogging of filter • Major clogging of heat exchanger • Major short-circuit • Major shortage of refrigerant amount • Compressor protection ON • Indoor fan tap • Valid setting of silent mode </td> </tr> </tbody> </table> | Diagnosis | Countermeasure | <p>Check the indoor fan operation. Check the temperature difference between return and supply air.</p> <pre> graph TD Start[Check indoor fan operation and temperature difference] --> D1{Is the temperature difference between return and supply air 10-20°C at cooling?} D1 -- YES --> D2{Does the heat load increase after installation?} D1 -- NO --> D3{Is the compressor operating?} D2 -- YES --> Box1[Mistake in model selection. Calculate heat load once more.] D2 -- NO --> CM1[It is normal. (This unit is designed to start in the soft start mode by detecting the under dome temperature of compressor when it restart after power reset.)] Box1 --> CM2[It is necessary to replace to higher capacity one or to install additional unit.] D3 -- NO --> D4{"⌚ WAIT ⌚" message is displayed (for 3 seconds) when performing cooling, defrosting and heating operations from the remote control.} D3 -- YES --> D5{Is the compressor rotation speed low?} D4 -- YES --> CM3[Compressor refrigerant oil protection control at starting is activated. For the contents of control, refer to the compressor start control of the microcomputer control functions.] D4 -- NO --> CM4[Compressor may be stopped by the error detection control. For the contents of control, refer to anomalous stop control by controlling compressor rotation speed of microcomputer control functions.] D5 -- NO --> CM5[Inspect the followings. • Minor clogging of filter • Minor clogging of heat exchanger • Minor short-circuit • Minor shortage of refrigerant amount • Poor compression of compressor] D5 -- YES --> Box2[Check which control "Determination control of compressor rotation speed" or "Protective control by controlling compressor rotation speed" is appropriate to this phenomenon.] Box2 --> D6{Are the temperature conditions of room and outdoor air close to the rated conditions? (1)} D6 -- YES --> CM6[Considering appropriate operation control, check suspicious points. Inspect the followings for reference. • Major clogging of filter • Major clogging of heat exchanger • Major short-circuit • Major shortage of refrigerant amount • Compressor protection ON • Indoor fan tap • Valid setting of silent mode] D6 -- NO --> End[The unit is operating normally but is operating under the control for protecting compressor or other respective parts.] </pre> <p>Note (1) Outdoor : 35°C, Indoor: 27°C</p> | <p>It is normal. (This unit is designed to start in the soft start mode by detecting the under dome temperature of compressor when it restart after power reset.)</p> <p>It is necessary to replace to higher capacity one or to install additional unit.</p> <p>Compressor refrigerant oil protection control at starting is activated. For the contents of control, refer to the compressor start control of the microcomputer control functions.</p> <p>Compressor may be stopped by the error detection control. For the contents of control, refer to anomalous stop control by controlling compressor rotation speed of microcomputer control functions.</p> <p>Inspect the followings.</p> <ul style="list-style-type: none"> • Minor clogging of filter • Minor clogging of heat exchanger • Minor short-circuit • Minor shortage of refrigerant amount • Poor compression of compressor <p>Considering appropriate operation control, check suspicious points. Inspect the followings for reference.</p> <ul style="list-style-type: none"> • Major clogging of filter • Major clogging of heat exchanger • Major short-circuit • Major shortage of refrigerant amount • Compressor protection ON • Indoor fan tap • Valid setting of silent mode |
| Diagnosis | Countermeasure | | | |
| <p>Check the indoor fan operation. Check the temperature difference between return and supply air.</p> <pre> graph TD Start[Check indoor fan operation and temperature difference] --> D1{Is the temperature difference between return and supply air 10-20°C at cooling?} D1 -- YES --> D2{Does the heat load increase after installation?} D1 -- NO --> D3{Is the compressor operating?} D2 -- YES --> Box1[Mistake in model selection. Calculate heat load once more.] D2 -- NO --> CM1[It is normal. (This unit is designed to start in the soft start mode by detecting the under dome temperature of compressor when it restart after power reset.)] Box1 --> CM2[It is necessary to replace to higher capacity one or to install additional unit.] D3 -- NO --> D4{"⌚ WAIT ⌚" message is displayed (for 3 seconds) when performing cooling, defrosting and heating operations from the remote control.} D3 -- YES --> D5{Is the compressor rotation speed low?} D4 -- YES --> CM3[Compressor refrigerant oil protection control at starting is activated. For the contents of control, refer to the compressor start control of the microcomputer control functions.] D4 -- NO --> CM4[Compressor may be stopped by the error detection control. For the contents of control, refer to anomalous stop control by controlling compressor rotation speed of microcomputer control functions.] D5 -- NO --> CM5[Inspect the followings. • Minor clogging of filter • Minor clogging of heat exchanger • Minor short-circuit • Minor shortage of refrigerant amount • Poor compression of compressor] D5 -- YES --> Box2[Check which control "Determination control of compressor rotation speed" or "Protective control by controlling compressor rotation speed" is appropriate to this phenomenon.] Box2 --> D6{Are the temperature conditions of room and outdoor air close to the rated conditions? (1)} D6 -- YES --> CM6[Considering appropriate operation control, check suspicious points. Inspect the followings for reference. • Major clogging of filter • Major clogging of heat exchanger • Major short-circuit • Major shortage of refrigerant amount • Compressor protection ON • Indoor fan tap • Valid setting of silent mode] D6 -- NO --> End[The unit is operating normally but is operating under the control for protecting compressor or other respective parts.] </pre> <p>Note (1) Outdoor : 35°C, Indoor: 27°C</p> | <p>It is normal. (This unit is designed to start in the soft start mode by detecting the under dome temperature of compressor when it restart after power reset.)</p> <p>It is necessary to replace to higher capacity one or to install additional unit.</p> <p>Compressor refrigerant oil protection control at starting is activated. For the contents of control, refer to the compressor start control of the microcomputer control functions.</p> <p>Compressor may be stopped by the error detection control. For the contents of control, refer to anomalous stop control by controlling compressor rotation speed of microcomputer control functions.</p> <p>Inspect the followings.</p> <ul style="list-style-type: none"> • Minor clogging of filter • Minor clogging of heat exchanger • Minor short-circuit • Minor shortage of refrigerant amount • Poor compression of compressor <p>Considering appropriate operation control, check suspicious points. Inspect the followings for reference.</p> <ul style="list-style-type: none"> • Major clogging of filter • Major clogging of heat exchanger • Major short-circuit • Major shortage of refrigerant amount • Compressor protection ON • Indoor fan tap • Valid setting of silent mode | | | |

Note:

| | | | | |
|------------------------------------|---------|----------------|-----------|--|
| Error code Remote control: None | LED | Green | Red | Content Operates but does not heat |
| | Indoor | Keeps flashing | Stays OFF | |
| | Outdoor | — | Stays OFF | |

| |
|--|
| 1. Applicable model |
| All models |
| 2. Error detection method |
| |
| 3. Condition of error displayed |
| |
| 4. Presumable cause |
| <ul style="list-style-type: none"> Faulty 4-way valve operation Poor compression of compressor Faulty expansion valve operation |

| 5. Troubleshooting | | | | |
|--|--|----------------|--|--|
| <table border="1"> <thead> <tr> <th>Diagnosis</th> <th>Countermeasure</th> </tr> </thead> <tbody> <tr> <td> <p>Check the indoor fan operation. Check the temperature difference between return and supply air.</p> <p>Is the temperature difference between return and supply air 10-30°C at heating?</p> <p>NO</p> <p>Is the compressor operating?</p> <p>NO</p> <p>“WAIT” message is displayed (for 3 seconds) when performing cooling, defrosting and heating operations from the remote control.</p> <p>NO</p> <p>Is the compressor rotation speed low?</p> <p>NO</p> <p>Check which control “Determination control of compressor rotation speed” or “Protective control by controlling compressor rotation speed” is appropriate to this phenomenon.</p> <p>Are the (1) temperature conditions of room and outdoor air close to the rated conditions?</p> <p>NO</p> <p>The unit is operating normally but is operating under the control for protecting compressor or other respective parts.</p> </td> <td> <p>It is normal. (This unit is designed to start in the soft start mode by detecting the under dome temperature of compressor when it restart after power reset.)</p> <p>It is necessary to replace to higher capacity one or to install additional unit.</p> <p>Compressor refrigerant oil protection control at starting is activated. For the contents of control, refer to the compressor start control of the microcomputer control functions.</p> <p>Compressor may be stopped by the error detection control. For the contents of control, refer to anomalous stop control by controlling compressor rotation speed of microcomputer control functions.</p> <p>Inspect the followings.</p> <ul style="list-style-type: none"> Minor clogging of filter Minor clogging of heat exchanger Minor short-circuit Minor shortage of refrigerant amount Poor compression of compressor <p>Considering appropriate operation control, check suspicious points. Inspect the followings for reference.</p> <ul style="list-style-type: none"> Major clogging of filter Major clogging of heat exchanger Major short-circuit Major shortage of refrigerant amount Compressor protection ON Indoor fan tap Valid setting of silent mode </td> </tr> </tbody> </table> | Diagnosis | Countermeasure | <p>Check the indoor fan operation. Check the temperature difference between return and supply air.</p> <p>Is the temperature difference between return and supply air 10-30°C at heating?</p> <p>NO</p> <p>Is the compressor operating?</p> <p>NO</p> <p>“WAIT” message is displayed (for 3 seconds) when performing cooling, defrosting and heating operations from the remote control.</p> <p>NO</p> <p>Is the compressor rotation speed low?</p> <p>NO</p> <p>Check which control “Determination control of compressor rotation speed” or “Protective control by controlling compressor rotation speed” is appropriate to this phenomenon.</p> <p>Are the (1) temperature conditions of room and outdoor air close to the rated conditions?</p> <p>NO</p> <p>The unit is operating normally but is operating under the control for protecting compressor or other respective parts.</p> | <p>It is normal. (This unit is designed to start in the soft start mode by detecting the under dome temperature of compressor when it restart after power reset.)</p> <p>It is necessary to replace to higher capacity one or to install additional unit.</p> <p>Compressor refrigerant oil protection control at starting is activated. For the contents of control, refer to the compressor start control of the microcomputer control functions.</p> <p>Compressor may be stopped by the error detection control. For the contents of control, refer to anomalous stop control by controlling compressor rotation speed of microcomputer control functions.</p> <p>Inspect the followings.</p> <ul style="list-style-type: none"> Minor clogging of filter Minor clogging of heat exchanger Minor short-circuit Minor shortage of refrigerant amount Poor compression of compressor <p>Considering appropriate operation control, check suspicious points. Inspect the followings for reference.</p> <ul style="list-style-type: none"> Major clogging of filter Major clogging of heat exchanger Major short-circuit Major shortage of refrigerant amount Compressor protection ON Indoor fan tap Valid setting of silent mode |
| Diagnosis | Countermeasure | | | |
| <p>Check the indoor fan operation. Check the temperature difference between return and supply air.</p> <p>Is the temperature difference between return and supply air 10-30°C at heating?</p> <p>NO</p> <p>Is the compressor operating?</p> <p>NO</p> <p>“WAIT” message is displayed (for 3 seconds) when performing cooling, defrosting and heating operations from the remote control.</p> <p>NO</p> <p>Is the compressor rotation speed low?</p> <p>NO</p> <p>Check which control “Determination control of compressor rotation speed” or “Protective control by controlling compressor rotation speed” is appropriate to this phenomenon.</p> <p>Are the (1) temperature conditions of room and outdoor air close to the rated conditions?</p> <p>NO</p> <p>The unit is operating normally but is operating under the control for protecting compressor or other respective parts.</p> | <p>It is normal. (This unit is designed to start in the soft start mode by detecting the under dome temperature of compressor when it restart after power reset.)</p> <p>It is necessary to replace to higher capacity one or to install additional unit.</p> <p>Compressor refrigerant oil protection control at starting is activated. For the contents of control, refer to the compressor start control of the microcomputer control functions.</p> <p>Compressor may be stopped by the error detection control. For the contents of control, refer to anomalous stop control by controlling compressor rotation speed of microcomputer control functions.</p> <p>Inspect the followings.</p> <ul style="list-style-type: none"> Minor clogging of filter Minor clogging of heat exchanger Minor short-circuit Minor shortage of refrigerant amount Poor compression of compressor <p>Considering appropriate operation control, check suspicious points. Inspect the followings for reference.</p> <ul style="list-style-type: none"> Major clogging of filter Major clogging of heat exchanger Major short-circuit Major shortage of refrigerant amount Compressor protection ON Indoor fan tap Valid setting of silent mode | | | |

Note:

| | | | | |
|------------------------------------|---------|-----------|-----------|---|
| Error code Remote control: None | LED | Green | Red | Content Earth leakage breaker activated |
| | Indoor | Stays OFF | Stays OFF | |
| | Outdoor | – | Stays OFF | |

| | | |
|---|---|-----------------------|
| <p>1. Applicable model</p> <p>All models</p> | 5. Troubleshooting | |
| <p>2. Error detection method</p> | Diagnosis | Countermeasure |
| <p>3. Condition of error displayed</p> | <pre> graph TD D1{Are OK the insulation resistance and resistance between terminals (1) of compressor? (1) See page 145.} D2{Is insulation of respective harnesses OK? Is any harness bitten between pannel and casing or etc?} P1[Check the outdoor unit grounding wire/earth leakage breaker.] D1 -- NO --> C1[Replace compressor.*] D1 -- YES --> D2 D2 -- NO --> C2[Secure insulation resistance.] D2 -- YES --> P1 </pre> <div style="border: 1px solid black; padding: 5px; margin-top: 10px;"> <p>Check of the outdoor unit grounding wire/earth leakage breaker</p> <p>① Run an independent grounding wire from the grounding screw of outdoor unit to the grounding terminal on the distribution panel. (Do not connect to another grounding wire.)</p> <p>② In order to prevent malfunction of the earth leakage breaker itself, confirm that it is conformed to higher harmonic regulation.</p> <p>* Insulation resistance of compressor</p> <ul style="list-style-type: none"> Immediately after installation or when the unit has been left for long time without power source, the insulation resistance may drop to a few MΩ because of refrigerant migrated in the compressor. <p>When the earth breaker is activated at lower insulation resistance, check the following points.</p> <p>① When power ON, crankcase heater heat up compressor and evaporate the refrigerant migrated in the compressor.</p> <p>② Check if the earth leakage breaker is conformed to higher harmonic regulation or not.</p> <p>Since the unit is equipped with inverter, it is necessary to use components conformed to higher harmonic regulation in order to prevent malfunction of earth leakage breaker.</p> </div> | |
| <p>4. Presumable cause</p> <ul style="list-style-type: none"> Defective compressor Noise | | |

Note:

| | | | | |
|------------------------------------|---------|-------|-----|---|
| Error code Remote control: None | LED | Green | Red | Content Excessive noise/vibration (1/3) |
| | Indoor | - | - | |
| | Outdoor | - | - | |

1. Applicable model
All models

2. Error detection method

3. Condition of error displayed

- 4. Presumable cause**
- ① Improper installation work
 - Improper anti-vibration work at installation
 - Insufficient strength of mounting face
 - ② Defective product
 - Before/after shipping from factory
 - ③ Improper adjustment during commissioning
 - Excess/shortage of refrigerant, etc.

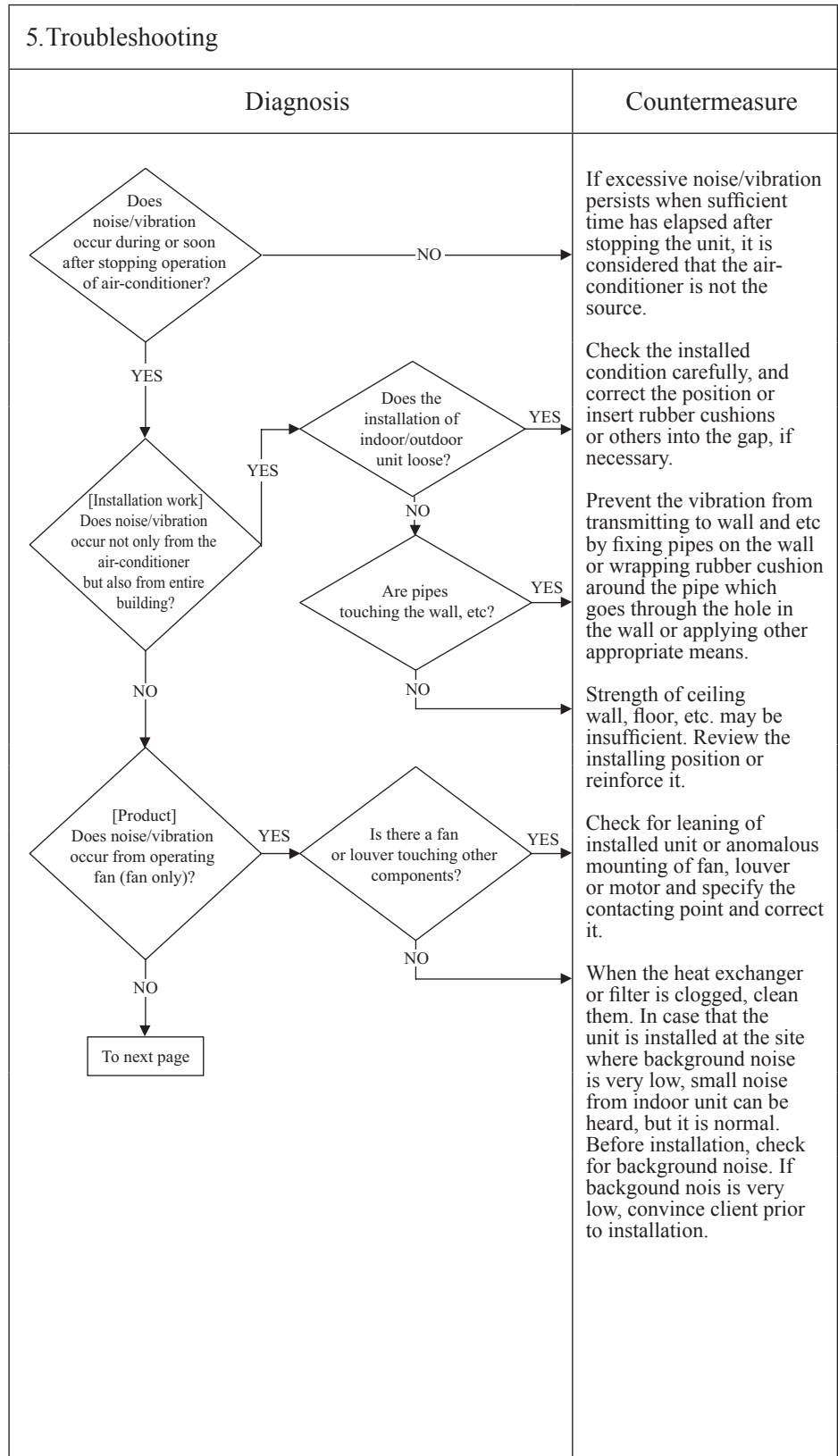

Note:

| | | | | |
|------------------------------------|---------|-------|-----|---|
| Error code Remote control: None | LED | Green | Red | Content Excessive noise/vibration (2/3) |
| | Indoor | — | — | |
| | Outdoor | — | — | |

| |
|--|
| 1. Applicable model |
| All models |
| 2. Error detection method |
| |
| 3. Condition of error displayed |
| |
| 4. Presumable cause |
| |

| | |
|---------------------------|---|
| 5. Troubleshooting | |
| Diagnosis | Countermeasure |
| | <p>Rearrange the piping to avoid contact with the casing.</p> <p>It is noise/vibration that is generated when the refrigerant gas or liquid flow through inside of piping of air-conditioner. It is likely to occur particularly during cooling or defrost operation in the heating mode. It is normal.</p> <p>The noise/vibration occurs when the refrigerant starts or stops flowing. It is normal.</p> <p>When the defrost operation starts or stops during heating, the refrigerant flow is reversed due to switching 4-way valve. This causes a large change in pressure which produces a blowing sound. It may accompany also the hissing sounds as mentioned above. They are normal.</p> <p>After the start or stop of heating operation or during defrost operation, abrupt changes in temperature cause resin parts to shrink or expand. This is normal.</p> <p>It is the sound produced by the drain pump that discharges drain from the indoor unit. The pump continues to run for 5 minutes after stopping the cooling operation. This is normal.</p> <p>Apply the damper sealant at places considered to be the sources such as the pressure reducing mechanism (expansion valve), capillary, etc.</p> |

Note:

| | | | | |
|------------------------------------|---------|-------|-----|---|
| Error code Remote control: None | LED | Green | Red | Content Excessive noise/vibration (3/3) |
| | Indoor | – | – | |
| | Outdoor | – | – | |

| | | |
|--|---|----------------|
| <p>1. Applicable model</p> <p>All models</p> | 5. Troubleshooting | |
| <p>2. Error detection method</p> | Diagnosis | Countermeasure |
| <p>3. Condition of error displayed</p> | <pre> graph TD A[From previous page] --> B{Adjustment during commissioning Does noise/vibration occur when the cooling/heating operation is in anomalous condition?} B -- YES --> C[Countermeasure] </pre> | |
| <p>4. Presumable cause</p> | <p>If insufficient cooling/heating problem happens due to anomalous operating conditions at cooling/heating, followings are suspicious.</p> <ul style="list-style-type: none"> • Overcharge of refrigerant • Insufficient charge of refrigerant • Intrusion of air, nitrogen, etc. <p>In such occasion, it is necessary to recover refrigerant, vacuum-dry and recharge refrigerant.</p> <p>* Since there could be many causes of noise/vibration, the above do not cover all. In such case, check the conditions when, where, how the noise/vibration occurs according to following check point.</p> <ul style="list-style-type: none"> • Indoor/outdoor unit • Cooling/heating/fan mode • Startup/stop/during operation • Operating condition (Indoor/outdoor temperatures, pressure) • Time it occurred • Operation data retained by the remote control such as compressor rotation speed, heat exchanger temperature, EEV opening degree, etc. • Tone (If available, record the noise) • Any other anomalies | |

Note:

| | | | | |
|------------------------------------|---------|----------------|-----------|--|
| Error code Remote control: None | LED | Green | Red | Content Louver motor failure (FDTC and FDE only) |
| | Indoor | Keeps flashing | Stays OFF | |
| | Outdoor | – | Stays OFF | |

1. Applicable model
FDTC and FDE series only

2. Error detection method

3. Condition of error displayed

4. Presumable cause

- Defective LM
- LM wire breakage
- Faulty indoor unit control PCB

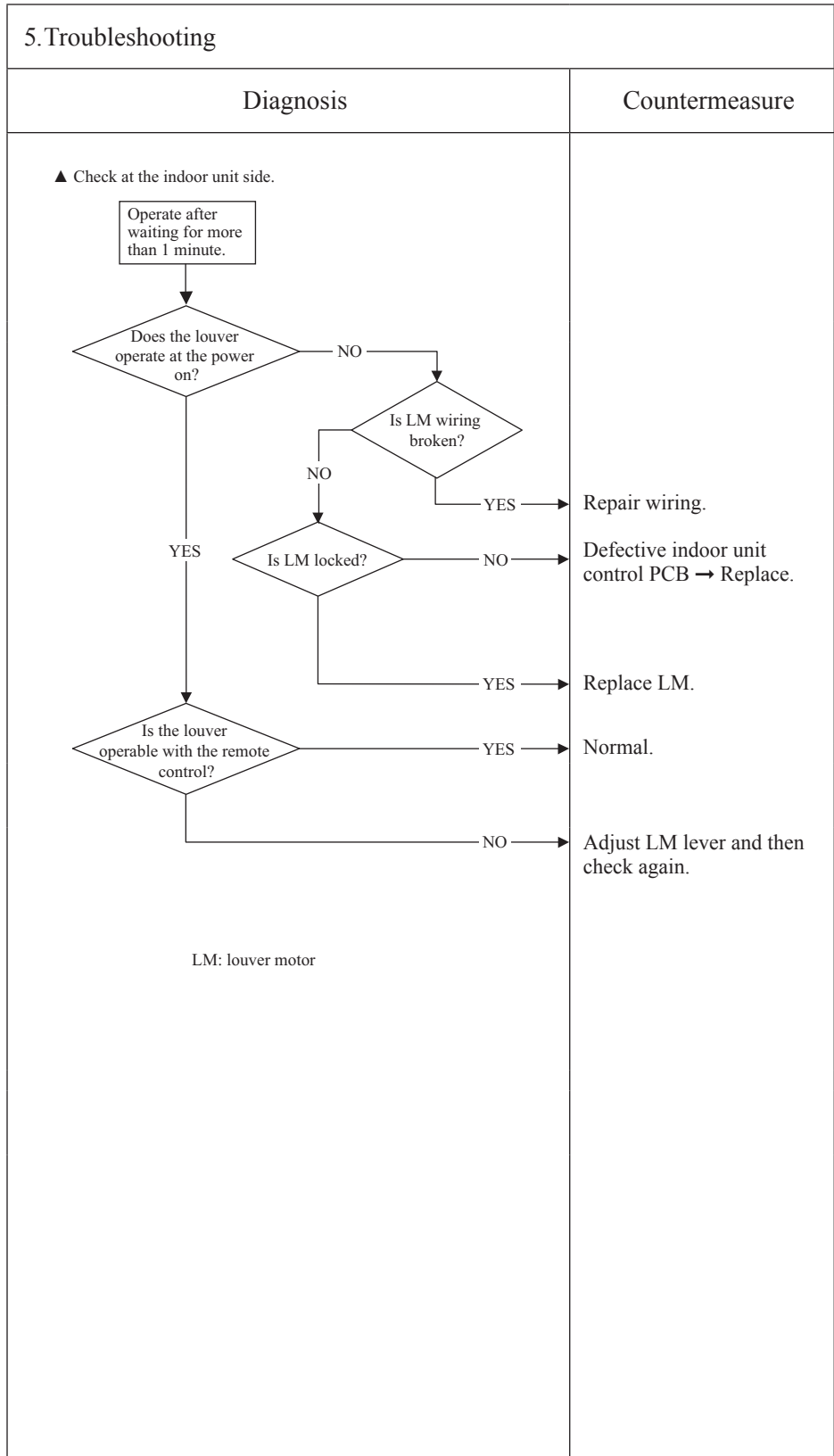

Note:

| | | | | |
|------------------------------------|---------|-----------|-----------|--|
| Error code Remote control: None | LED | Green | Red | Content Power source system error (Power source to indoor unit control PCB) |
| | Indoor | Stays OFF | Stays OFF | |
| | Outdoor | — | Stays OFF | |

| |
|---|
| 1. Applicable model |
| All models |
| 2. Error detection method |
| |
| 3. Condition of error displayed |
| |
| 4. Presumable cause |
| <ul style="list-style-type: none"> • Misconnection or breakage of connecting wires • Blown fuse • Faulty indoor unit control PCB • Broken harness • Faulty outdoor unit sub PCB (Noise filter) |

| | |
|---------------------------|-----------------------|
| 5. Troubleshooting | |
| Diagnosis | Countermeasure |
| | |

Note:

| | | | | |
|------------------------------------|---------|----------------|--------------|--|
| Error code Remote control: None | LED | Green | Red | Content Power source system error (Power source to remote control) |
| | Indoor | Keeps flashing | 3-time flash | |
| | Outdoor | — | Stays OFF | |

1. Applicable model
All models

2. Error detection method

3. Condition of error displayed

- 4. Presumable cause**
- Remote control wire breakage/short-circuit
 - Defective remote control
 - Malfunction by noise
 - Broken harness
 - Faulty indoor unit control PCB

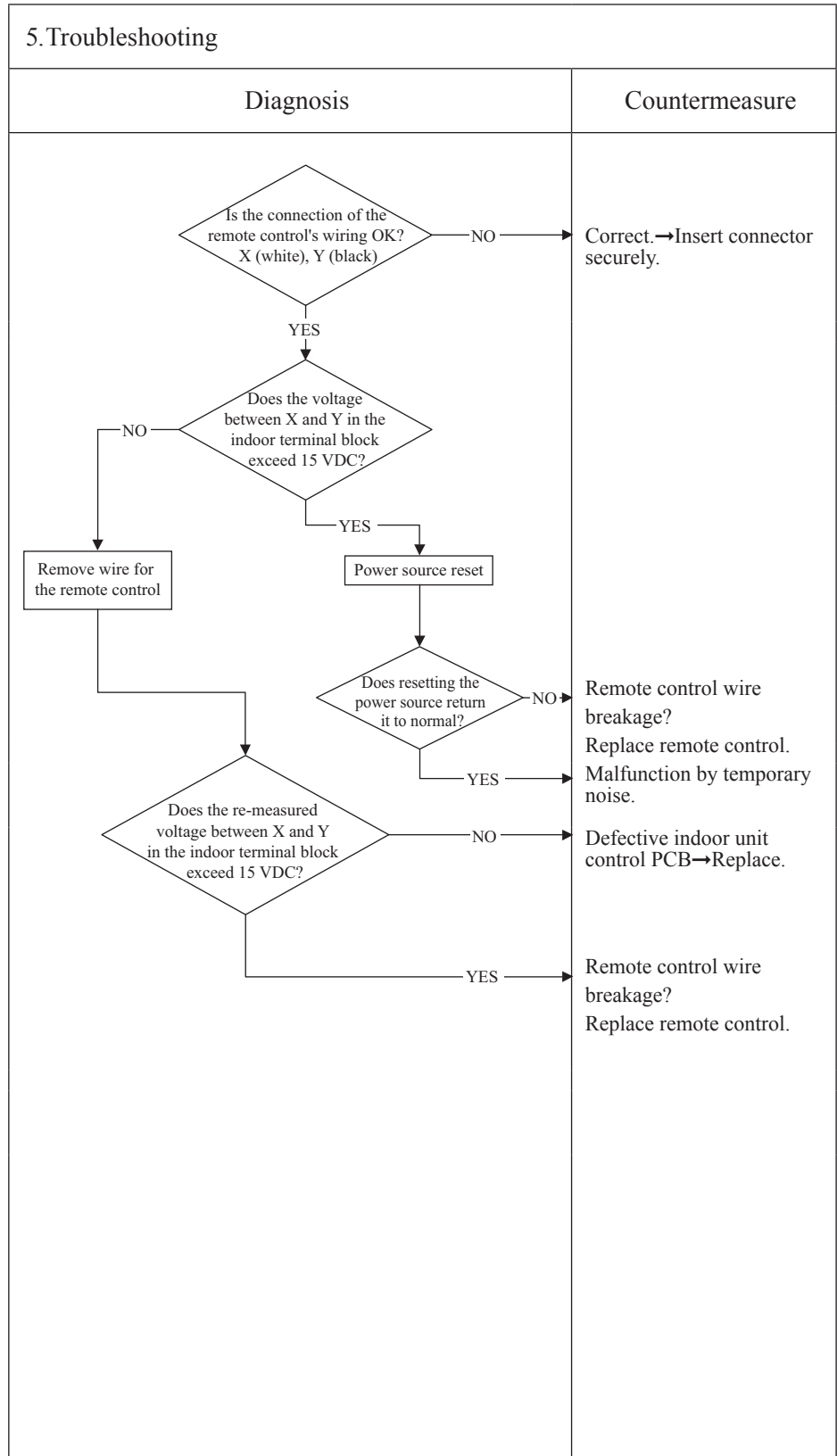

Note:

| | | | | |
|---|---------|----------------|-----------|--|
| Error code Remote control: INSPECT I/U | LED | Green | Red | Content INSPECT I/U (When 1 or 2 remote controls are connected) |
| | Indoor | Keeps flashing | Stays OFF | |
| | Outdoor | — | Stays OFF | |

| |
|----------------------------|
| 1. Applicable model |
| All models |

| |
|---|
| 2. Error detection method |
| Communication between indoor unit and remote control is disabled for more than 30 minutes after the power on. |

| |
|--|
| 3. Condition of error displayed |
| Same as above |

| |
|---|
| 4. Presumable cause |
| <ul style="list-style-type: none"> • Improper setting • Surrounding environment • Defective remote control communication circuit • Faulty indoor unit control PCB |

| | |
|--|--|
| 5. Troubleshooting | |
| Diagnosis | Countermeasure |
| <pre> graph TD Q1{Are 2 units of remote control connected?} Q2{Is it set at the slave remote control?} Q3{Does it become normal?} Q4{Do more than one indoor units have the same address?} Q5{Are remote control wires laid along high voltage wires?} Q6{Does DM start 60 seconds later automatically.} Q1 -- YES --> S1[Set one remote control for "Master" and the other for "Slave"] S1 --> Q3 Q3 -- YES --> C1[Normal] Q3 -- NO --> Q4 Q1 -- NO --> Q2 Q2 -- YES --> C2[Set SW1 on remote control PCB at "Master".] Q2 -- NO --> Q3 Q4 -- YES --> C3[Set address again. (SW2 on indoor unit control PCB)] Q4 -- NO --> Q5 Q5 -- YES --> C4[Separate remote control wires from high voltage wires.] Q5 -- NO --> S2[Disconnect the connecting wire ③ between the indoor and outdoor unit.] S2 --> S3[Power source reset] S3 --> Q6 Q6 -- YES --> C5[Defective indoor unit control PCB → Replace.] Q6 -- NO --> C6[Defective remote control → Change.] </pre> | <p>Set SW1 on remote control PCB at "Master".</p> <p>Normal</p> <p>Set address again. (SW2 on indoor unit control PCB)</p> <p>Separate remote control wires from high voltage wires.</p> <p>Defective indoor unit control PCB → Replace.</p> <p>Defective remote control → Change.</p> |

Note: If any error is detected 30 minutes after displaying "WAIT" on the remote control, the display changes to "INSPECT I/U".

| | | | | |
|---|---------|----------------|-----------|--|
| Error code Remote control: INSPECT I/U | LED | Green | Red | Content INSPECT I/U (Connection of 3 units or more remote controls) |
| | Indoor | Keeps flashing | Stays OFF | |
| | Outdoor | — | Stays OFF | |

| |
|----------------------------|
| 1. Applicable model |
| All models |

| |
|---|
| 2. Error detection method |
| Indoor unit cannot communicate for more than 30 minutes after the power on with remote control. |

| |
|--|
| 3. Condition of error displayed |
| Same as above |

| |
|--|
| 4. Presumable cause |
| <ul style="list-style-type: none"> • Improper setting • Surrounding environment • Defective remote control communication circuit • Faulty indoor unit control PCB • Faulty outdoor unit sub PCB |

| | |
|---|--|
| 5. Troubleshooting | |
| Diagnosis | Countermeasure |
| <pre> graph TD Q1{Are more than 3 units of remote control connected?} -- YES --> C1[Reduce to 2 units or less.] Q1 -- NO --> Q2{Does remote control display "Slave"?} Q2 -- YES --> C2[Change remote control setting to "Master". (SW1 on remote control PCB)] Q2 -- NO --> Q3{Do more than one indoor units have the same address?} Q3 -- YES --> C3[Change address. (SW2 on indoor unit control PCB)] Q3 -- NO --> Q4{Is it set to a slave indoor unit. SW5-1, 2?} Q4 -- YES --> C4[Change to master. (SW5-1, 2 on indoor unit control PCB)] Q4 -- NO --> Q5{Is there loose or wrong connection at the terminal of wiring between indoor and outdoor units?} Q5 -- YES --> C5[Correct] Q5 -- NO --> Q6{Is the grounding wire connected properly?} Q6 -- YES --> Q7{Is approx. DC20V detected between ②-③ on the outdoor unit terminal block?} Q6 -- NO --> C6[Correct] Q7 -- NO --> C7[Defective outdoor unit control PCB → Replace.] Q7 -- YES --> Q8{Is approx. DC20V detected between ②-③ on the indoor unit terminal block?} Q8 -- NO --> C8[Broken connecting wire → Correct.] Q8 -- YES --> C9[Defective indoor unit control PCB → Replace.] </pre> | <p>Reduce to 2 units or less.</p> <p>Change remote control setting to “Master”. (SW1 on remote control PCB)</p> <p>Change address. (SW2 on indoor unit control PCB)</p> <p>Change to master. (SW5-1, 2 on indoor unit control PCB)</p> <p>Correct</p> <p>Correct</p> <p>Defective outdoor unit control PCB → Replace.</p> <p>Broken connecting wire → Correct.</p> <p>Defective indoor unit control PCB → Replace.</p> |

Note: If any error is detected 30 minutes after displaying “WAIT” on the remote control, the display changes to “INSPECT I/U”.

| | | | | |
|--------------------------------------|---------|----------------|-----------|--|
| Error code Remote control: 🏠WAIT🏠 | LED | Green | Red | Content Communication error at initial operation (1/3) |
| | Indoor | Keeps flashing | Stays OFF | |
| | Outdoor | – | Stays OFF | |

1. Applicable model

All Models

When the remote control LCD displays “🏠WAIT🏠” 2 minutes after the power on.

2. Error detection method

3. Condition of error displayed

4. Presumable cause

- Blown fuse
- Faulty outdoor unit sub PCB
- Connection between PCB's
- Blown fuse on single phase model
- Faulty indoor unit control PCB
- Defective remote control
- Broken remote control wire

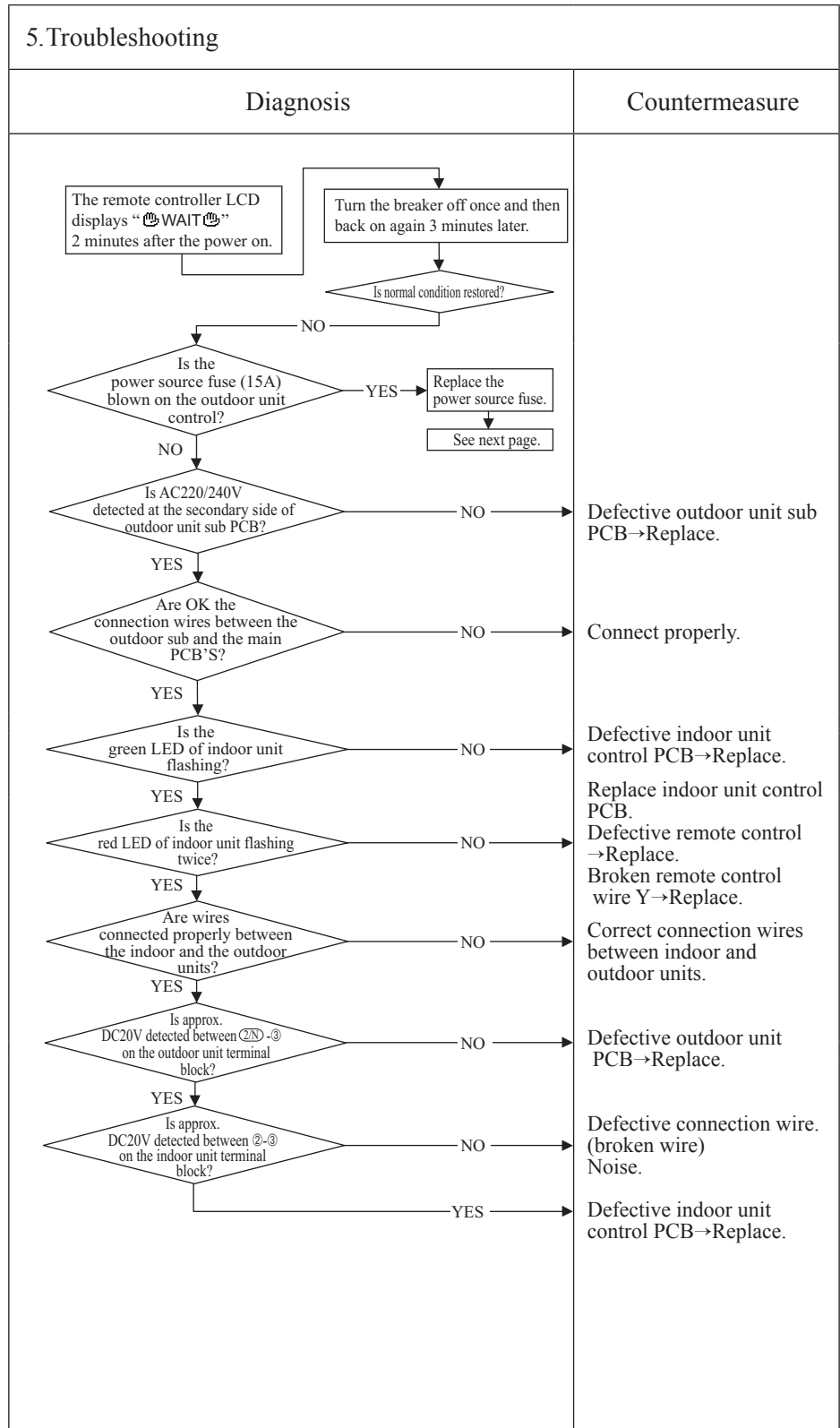

Note: If any anomaly is detected during communication, the error code E5 is displayed. Inspection procedure is same as above. (Excluding matters related to connection) When the power source is reset after the occurrence of E5, the LED will display “🏠WAIT🏠” if the anomaly continues. If the breaker ON/OFF is repeated in a short period of time (within 1 minute), “🏠WAIT🏠” may be displayed. In such occasion, turn the breaker off and wait for 3 minutes.

| | | | | |
|---|------------|----------------|------------|--|
| Error code Remote control: 🏠 WAIT 🏠 | LED | Green | Red | Content Communication error at initial operation (2/3) |
| | Indoor | Keeps flashing | Stays OFF | |
| | Outdoor | – | Stays OFF | |

1. Applicable model

All Models

When the fuse is blown, the method to inspect outdoor sub PCB before replacing the power source fuse

2. Error detection method

3. Condition of error displayed

4. Presumable cause

- Blown fuse
- Faulty outdoor unit sub PCB
- Faulty outdoor unit main PCB
- Faulty reactor

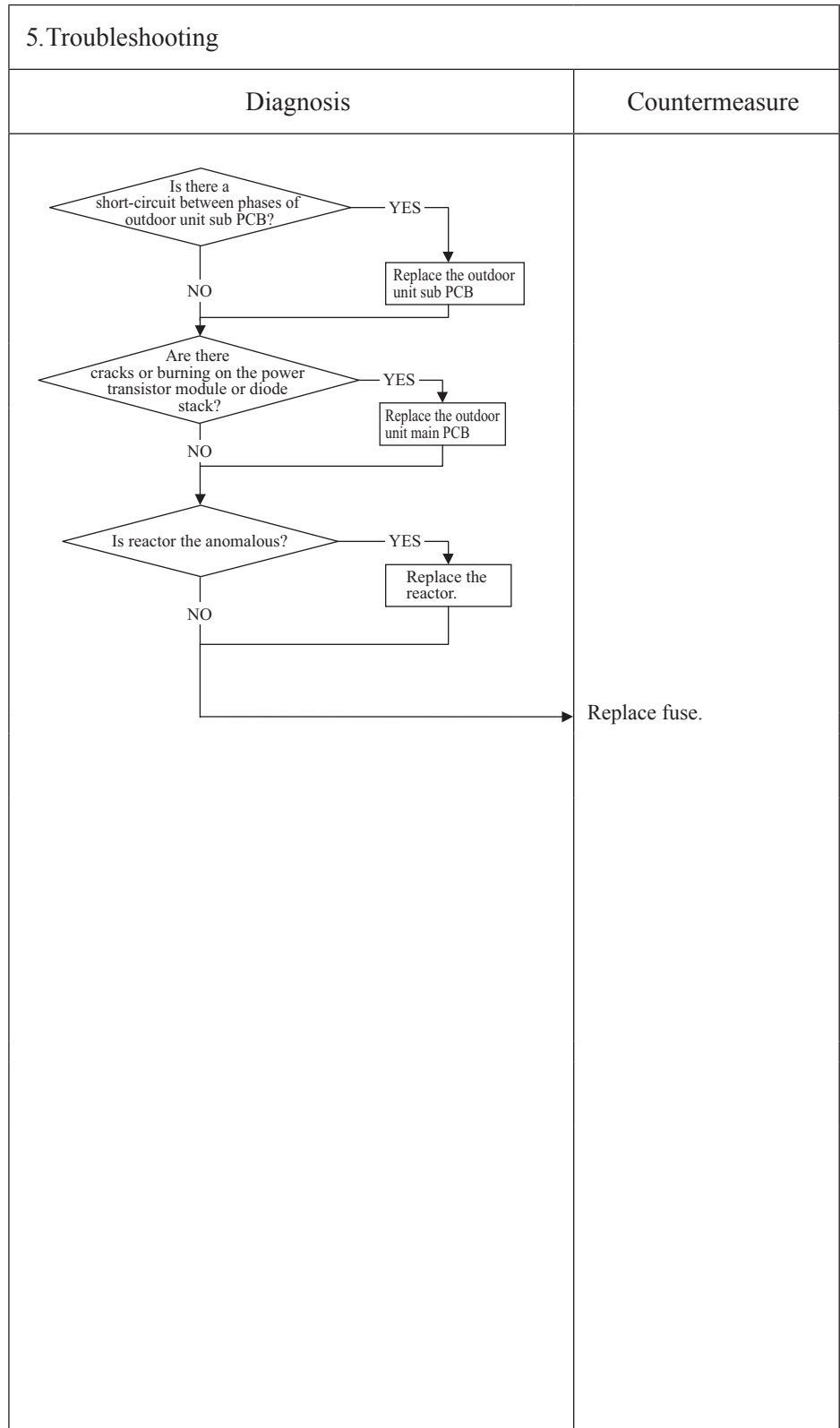

Note:

| | | | | |
|--|---------|----------------|-----------|--|
| Error code Remote control: 🏠 WAIT 🏠 | LED | Green | Red | Content Communication error at initial operation (3/3) |
| | Indoor | Keeps flashing | Stays OFF | |
| | Outdoor | – | Stays OFF | |

1. Applicable model
All Models
When the remote control display is extinguished after the power on.

2. Error detection method

3. Condition of error displayed

- 4. Presumable cause**
- Blown fuse
 - Connection between PCB's
 - Blown fuse
 - Faulty indoor unit control PCB
 - Defective remote control
 - Wire breakage on remote control
 - Faulty outdoor unit sub PCB

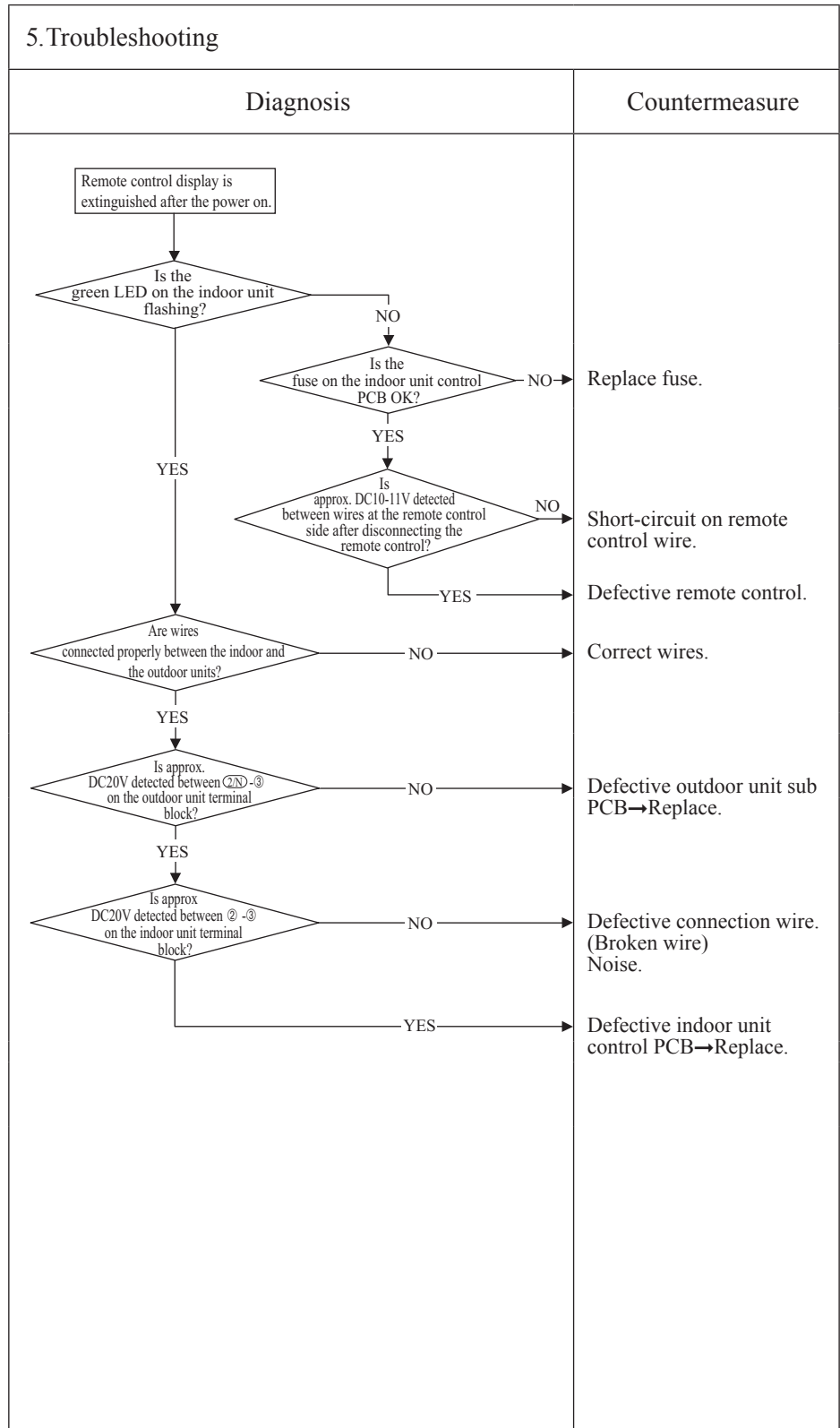

Note:

| | | | | |
|------------------------------------|---------|-----------|-----------|----------------------------------|
| Error code Remote control: None | LED | Green | Red | Content No display |
| | Indoor | Stays OFF | Stays OFF | |
| | Outdoor | — | Stays OFF | |

| |
|--|
| 1. Applicable model |
| All models |
| 2. Error detection method |
| |
| 3. Condition of error displayed |
| |
| 4. Presumable cause |
| <ul style="list-style-type: none"> • Faulty indoor unit control PCB • Defective remote control • Broken remote control wire |

| | |
|---|-----------------------|
| 5. Troubleshooting | |
| Diagnosis | Countermeasure |
| <pre> graph TD Start[Remote control does not display anything after the power on.] --> D1{Is DC10V or higher detected at remote control connection terminals?} D1 -- YES --> C1[Defective remote control.] D1 -- NO --> D2{Is DC10V or higher detected on remote control wires if the remote control is removed?} D2 -- YES --> C2[Defective remote control.] D2 -- NO --> D3{Are wires connected properly between the indoor/outdoor units?} D3 -- YES --> C3["Defective connecting wire. Defective remote control wire. (Short-circuit, etc.)"] D3 -- NO --> C4[Defective indoor unit control PCB → Replace.] </pre> | |

Note:

| | | | | |
|----------------------------------|---------|----------------|-----------|---------|
| Error code Remote control: E1 | LED | Green | Red | Content |
| | Indoor | Keeps flashing | Stays OFF | |
| | Outdoor | — | Stays OFF | |

Remote control communication circuit error

1. Applicable model
All models

2. Error detection method
When normal communication between the remote control and the indoor unit is interrupted for more than 2 minutes. (Detectable only with the remote control)

3. Condition of error displayed
Same as above

- 4. Presumable cause**
- Defective communication circuit between remote control-indoor unit
 - Noise
 - Defective remote control
 - Faulty indoor unit control PCB

5. Troubleshooting

| Diagnosis | Countermeasure |
|---|--|
| <pre> graph TD A{Is it possible to reset normally by the power reset?} -- YES --> B[Malfunction by noise Check peripheral environment.] A -- NO --> C[Turn SW7-1 to OFF. → ON Remove the wire ③ connecting between indoor/outdoor units.] C --> D[Power source reset] D --> E{(1) Does the drain pump restart automatically 1 minute later?} E -- YES --> F[Defective indoor unit control PCB → Replace.] E -- NO --> G[Defective remote control → Replace.] </pre> <p>Note (1) Only indoor unit with drain pump</p> <p>Note (2) Does the remote control still display “WAIT” even after 3 minutes?</p> | <p>Malfunction by noise Check peripheral environment.</p> <p>Defective indoor unit control PCB → Replace.</p> <p>Defective remote control → Replace.</p> |

Note: If the indoor unit cannot communicate normally with the remote control for 180 seconds, the indoor unit control PCB starts to reset automatically.

| | | | | |
|----------------------------------|---------|----------------|--------------|--|
| Error code Remote control: E5 | LED | Green | Red | Content Communication error during operation |
| | Indoor | Keeps flashing | 2-time flash | |
| | Outdoor | — | 6-time flash | |

| |
|---------------------------|
| 1.Applicable model |
| All models |

| |
|---|
| 2.Error detection method |
| When normal communication between indoor and outdoor unit is interrupted for more than 2 minutes. |

| |
|---|
| 3.Condition of error displayed |
| Same as above is detected during operation. |

| |
|--|
| 4.Presumable cause |
| <ul style="list-style-type: none"> • Unit No. setting error • Broken remote control wire • Faulty remote control wire connection • Faulty outdoor unit sub PCB |

| | |
|--|-----------------------|
| 5.Troubleshooting | |
| Diagnosis | Countermeasure |
| <p style="text-align: center;">Note (1) Inspect faulty connections (disconnection, looseness) on the outdoor unit terminal block.</p> <p style="text-align: center;">Is the connection of signal wires at the outdoor unit side OK?</p> <p style="text-align: right;">NO → Repair signal wires.</p> <p style="text-align: center;">YES</p> <p style="text-align: center;">Note (2) Check for faulty connection or breakage of signal wires between indoor-outdoor units.</p> <p style="text-align: center;">Is the connection of signal wires between indoor-outdoor units OK?</p> <p style="text-align: right;">NO → Repair signal wires.</p> <p style="text-align: center;">YES</p> <p style="text-align: center;">Power source reset</p> <p style="text-align: center;">Has the remote control LCD returned to normal state?</p> <p style="text-align: right;">NO → Defective outdoor sub PCB (Defective network communication circuit) → Replace.</p> <p style="text-align: right;">YES → Unit is normal. (Malfunction by temporary noise, etc.)</p> | |

Note:

| | | | | |
|---|------------|----------------|--------------|--|
| Error code Remote control: E6 | LED | Green | Red | Content Indoor heat exchanger temperature sensor anomaly |
| | Indoor | Keeps flashing | 1-time flash | |
| | Outdoor | — | Stays OFF | |

1. Applicable model

All models

2. Error detection method

Anomalously low temperature or high temperature (resistance) is detected on the indoor heat exchanger temperature sensor (Thi-R1, R2 or R3).

3. Condition of error displayed

- When the temperature sensor detects -50°C or lower for 5 seconds continuously, the compressor stops. After 3-minute delay, the compressor starts again automatically, but if this error occurs again within 60 minutes after the initial detection.
- Or if 70°C or higher is detected for 5 seconds continuously.

4. Presumable cause

- Defective indoor heat exchanger temperature sensor connector
- Indoor heat exchanger temperature sensor anomaly
- Faulty indoor unit control PCB

5. Troubleshooting

| Diagnosis | Countermeasure |
|---|--|
| <pre> graph TD Q1{Is the connection of indoor heat exchanger temperature sensor connector OK?} Q2{Are characteristics of indoor heat exchanger temperature sensor OK?} Q1 -- NO --> C1[Correct. → Insert connector securely.] Q1 -- YES --> Q2 Q2 -- NO --> C2[Defective indoor heat exchanger temperature sensor → Replace.] Q2 -- YES --> C3[Defective indoor unit control PCB → Replace. (Defective indoor heat exchanger temperature sensor input circuit)] </pre> | <p>Correct. → Insert connector securely.</p> <p>Defective indoor heat exchanger temperature sensor → Replace.</p> <p>Defective indoor unit control PCB → Replace. (Defective indoor heat exchanger temperature sensor input circuit)</p> |
| <p>Temperature-resistance characteristic</p> <p>(Broken wire)</p> <p>(Short-circuit)</p> <p>Temperature sensor resistance (kΩ)</p> <p>Temperature (°C)</p> <p>5kΩ at 25°C</p> | |

Note:

| | | | | |
|----------------------------------|---------|----------------|--------------|---|
| Error code Remote control: E7 | LED | Green | Red | Content Return air temperature sensor anomaly |
| | Indoor | Keeps flashing | 1-time flash | |
| | Outdoor | – | Stays OFF | |

1. Applicable model
All models

2. Error detection method
Anomalously low temperature or high temperature (resistance) is detected by indoor return air temperature sensor (Thi-A)

3. Condition of error displayed

- When the temperature sensor detects -50°C or lower for 5 seconds continuously, the compressor stops. After 3-minute delay, the compressor starts again automatically, but if this error occurs again within 60 minutes after the initial detection.

4. Presumable cause

- Defective return air temperature sensor connector
- Defective return air temperature sensor
- Faulty indoor unit control PCB

5. Troubleshooting

| Diagnosis | Countermeasure |
|---|--|
| <p>Is the connection of return air temperature sensor connector OK?</p> <p>NO →</p> <p>YES →</p> <p>Are the characteristics of return air temperature sensor OK?</p> <p>NO →</p> <p>YES →</p> | <p>Correct. → Connect connector.</p> <p>Defective return air temperature sensor → Replace.</p> <p>Defective indoor unit control PCB → Replace. (Defective return air temperature sensor input circuit)</p> |

Temperature-resistance characteristic

| Temperature (°C) | Temperature sensor resistance (kΩ) |
|------------------|------------------------------------|
| 0 | 15 |
| 10 | 10 |
| 20 | 7 |
| 25 | 5 |
| 30 | 4 |
| 40 | 3 |
| 50 | 2 |

Note:

| | | | | |
|----------------------------------|---------|----------------|--------------|--|
| Error code Remote control: E8 | LED | Green | Red | Content Heating overload operation |
| | Indoor | Keeps flashing | 1-time flash | |
| | Outdoor | — | Stays OFF | |

| |
|----------------------------|
| 1. Applicable model |
| All models |

| |
|---|
| 2. Error detection method |
| Indoor heat exchanger temperature sensor (Thi-R1, R2, R3) |

| |
|---|
| 3. Condition of error displayed |
| When it is detected 5 times within 60 minutes from initial detection or when the overload condition is detected for 6 minutes continuously. |

| |
|--|
| 4. Presumable cause |
| <ul style="list-style-type: none"> • Clogged air filter • Defective indoor heat exchanger temperature sensor connector • Defective indoor heat exchanger temperature sensor • Anomalous refrigerant system |

| | |
|--|-----------------------|
| 5. Troubleshooting | |
| Diagnosis | Countermeasure |
| <pre> graph TD Q1{Is the air filter clogged?} -- YES --> C1[Wash.] Q1 -- NO --> Q2{Is the indoor heat exchanger temperature sensor connection OK?} Q2 -- YES --> Q3{Are the characteristics of indoor heat exchanger temperature sensor OK?} Q2 -- NO --> C2[Defective indoor heat exchanger temperature sensor connector -> Correct.] Q3 -- YES --> R1[Check the error data with the remote control.] Q3 -- NO --> C3[Defective indoor heat exchanger temperature sensor.] R1 --> Q4{Is the unit operating in the state of heating overload?} Q4 -- YES --> C4[Adjust.] Q4 -- NO --> C5[Check refrigerant system.] </pre> | |
| <p>Note (1) Judge if it is in the state of overload or not as follows.</p> <ul style="list-style-type: none"> • Is there any short-circuit of air? • Isn't there any fouling or clogging on the indoor heat exchanger? • Is the outdoor fan control normal? • Isn't the room and outdoor air temperature too high? <p>Note (2) For characteristics of indoor heat exchanger temperature sensor, see the error display E6.</p> | |
| <p style="text-align: center;">Indoor heat exchanger temperature (°C)</p> | |

Note: During heating operation; After starting compressor, compressor rotation speed is decreased by detecting indoor heat exchanger temperature (Thi-R) in order to control high pressure.

| | | | | |
|----------------------------------|---------|----------------|--------------|--|
| Error code Remote control: E9 | LED | Green | Red | Content Drain trouble (FDTC and FDUM only) |
| | Indoor | Keeps flashing | 1-time flash | |
| | Outdoor | — | Stays OFF | |

1. Applicable model
FDTC and FDUM series only

2. Error detection method
Float switch is activated

3. Condition of error displayed
If the float switch OPEN is detected for 3 seconds continuously or if float switch connector or wire is disconnected.

- 4. Presumable cause**
- Defective indoor unit control PCB
 - Float switch setting error
 - Humidifier drain pump motor interlock setting error
 - Option equipment setting error
 - Drain piping error
 - Defective drain pump motor
 - Disconnection of drain pump motor wiring

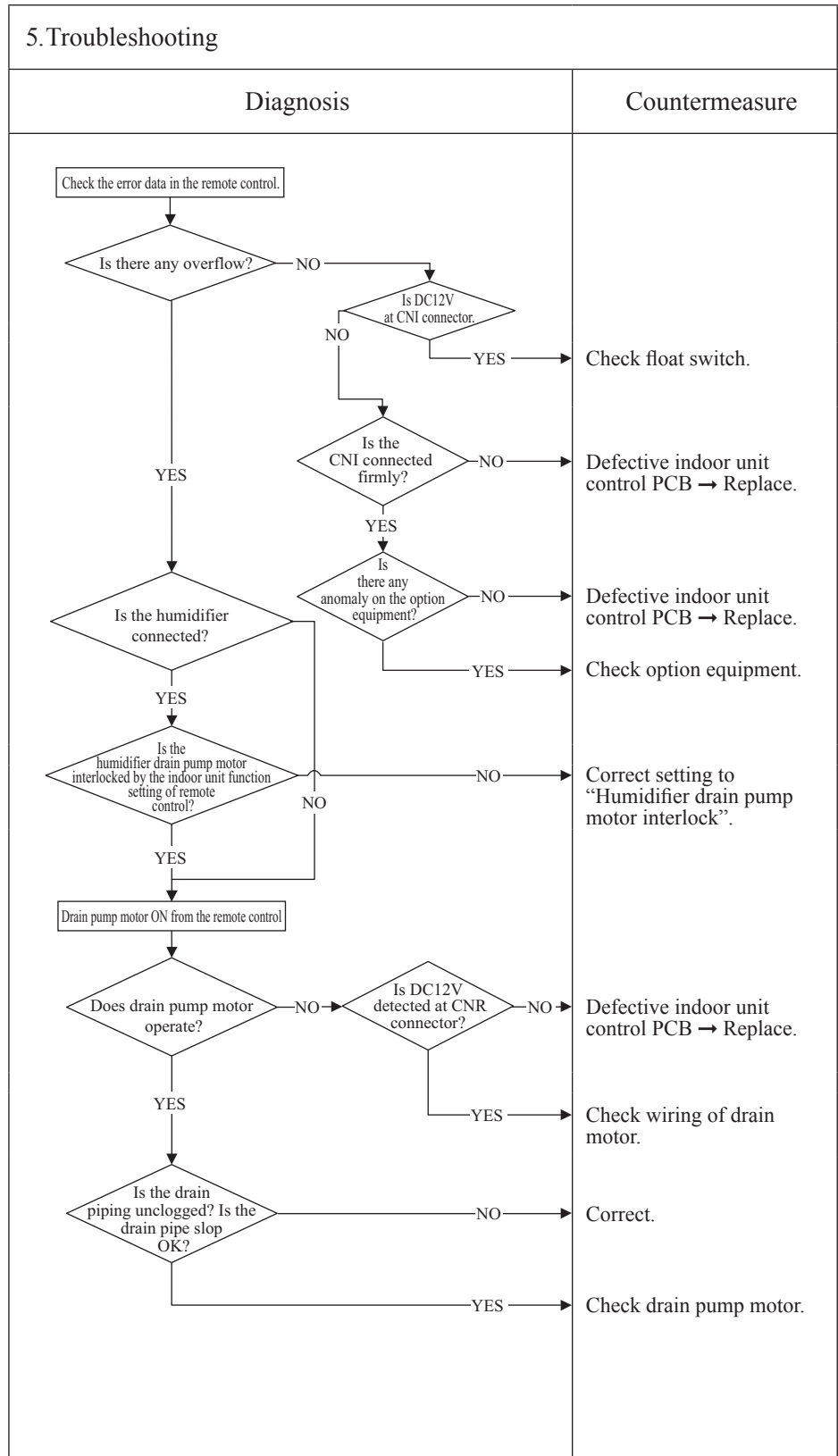

Note: When this error occurred at power ON, disconnection of wire or connector of the float switch is suspected. Check and correct it (or replace it, if necessary).

| | | | | |
|-----------------------------------|---------|----------------|-----------|---|
| Error code Remote control: E10 | LED | Green | Red | Content Excessive number of connected indoor units (more than 17 units) by controlling with one remote control |
| | Indoor | Keeps flashing | Stays OFF | |
| | Outdoor | — | Stays OFF | |

| <p>1. Applicable model</p> <p>All models</p> | <p>5. Troubleshooting</p> <table border="1" style="width: 100%;"> <thead> <tr> <th style="width: 50%;">Diagnosis</th> <th style="width: 50%;">Countermeasure</th> </tr> </thead> <tbody> <tr> <td style="text-align: center;"> <pre> graph LR A{Are more than 17 indoor units connected to one remote control?} -- NO --> B[Defective remote control -> Replace.] A -- YES --> C[Reduce to 16 or less units.] </pre> </td> <td></td> </tr> </tbody> </table> | | Diagnosis | Countermeasure | <pre> graph LR A{Are more than 17 indoor units connected to one remote control?} -- NO --> B[Defective remote control -> Replace.] A -- YES --> C[Reduce to 16 or less units.] </pre> | |
|--|--|--|-----------|----------------|--|--|
| Diagnosis | Countermeasure | | | | | |
| <pre> graph LR A{Are more than 17 indoor units connected to one remote control?} -- NO --> B[Defective remote control -> Replace.] A -- YES --> C[Reduce to 16 or less units.] </pre> | | | | | | |
| <p>2. Error detection method</p> <p>When it detects more than 17 of indoor units connected to one remote control</p> | | | | | | |
| <p>3. Condition of error displayed</p> <p>Same as above</p> | | | | | | |
| <p>4. Presumable cause</p> <ul style="list-style-type: none"> • Excessive number of indoor units connected • Defective remote control | | | | | | |

Note:

| | | | | |
|-----------------------------------|---------|----------------|----------------|---|
| Error code Remote control: E11 | LED | Green | Red | Content Address setting error of indoor units |
| | Indoor | Keeps flashing | Keeps flashing | |
| | Outdoor | – | Stays OFF | |

| | | |
|--|--|-----------------------|
| <p>1. Applicable model</p> <p>All models</p> | 5. Troubleshooting | |
| <p>2. Error detection method</p> <p>IU address has been set using the “Master IU address set” function of remote control.</p> | Diagnosis | Countermeasure |
| <p>3. Condition of error displayed</p> <p>Same as above</p> | <pre> graph TD A[E11 occurs] --> B{Is "Master IU address set" function of remote control used?} B -- YES --> C[Countermeasure] </pre> <p>In case the wiring is below and “Mastar IU address set” is used, E11 is appeared.</p> <pre> graph TD RC[R/C] --- IU1[IU 1] RC --- IU2[IU 2] RC --- IU3[IU 3] </pre> | |
| <p>4. Presumable cause</p> <p>Same as above</p> | <ul style="list-style-type: none"> • In cases of RC-EX3A Menu → Service setting → IU settings → Select IU • In cases of RC-E5 Return address No. to “IU ...” using [▲] or [▼] button. | |

Note:

| | | | | |
|-----------------------------------|---------|----------------|--------------|--|
| Error code Remote control: E16 | LED | Green | Red | Content Indoor fan motor anomaly |
| | Indoor | Keeps flashing | 1-time flash | |
| | Outdoor | — | Stays OFF | |

| |
|----------------------------|
| 1. Applicable model |
| All models |

| |
|--|
| 2. Error detection method |
| Detected by rotation speed of indoor fan motor |

| |
|--|
| 3. Condition of error displayed |
| <ul style="list-style-type: none"> When actual rotation speed of indoor fan motor drops to lower than 200min⁻¹ for 30 seconds continuously, the compressor and the indoor fan motor stop. After 2-seconds, it starts again automatically, but if this error occurs 4 times within 60 minutes after the initial detection. |

| |
|--|
| 4. Presumable cause |
| <ul style="list-style-type: none"> Defective indoor unit control PCB Foreign material at rotational area of fan propeller Defective fan motor Dust on indoor unit control PCB Blown fuse External noise, surge |

| | |
|--|-----------------------|
| 5. Troubleshooting | |
| Diagnosis | Countermeasure |
| <pre> graph TD D1{Does any foreign material intervene in rotational area of fan propeller?} -- YES --> C1[Remove foreign material.] D1 -- NO --> D2{Does the fan rotate smoothly when turned by hand?} D2 -- YES --> D3{Is DC280V detected between ①-④ of fan motor connector CNM?} D2 -- NO --> C2[Replace the fan motor.] D3 -- YES --> PR[Power source reset] D3 -- NO --> D4{Is the fuse F2 (FDUM, FDE: F3) blown?} PR --> D5{Is it normalized?} D4 -- YES --> C3[Replace faulty fan motor and indoor unit control PCB.] D4 -- NO --> C4[Check power voltage.] D5 -- YES --> C5[Malfunction by temporary noise.] D5 -- NO --> C6[Replace fan motor. (If the error persists after replacing the fan motor, replace the indoor unit control PCB.)] </pre> | |

Note:

| | | | | |
|-----------------------------------|---------|----------------|--------------|---|
| Error code Remote control: E19 | LED | Green | Red | Content Indoor unit operation check, drain pump moter check setting error |
| | Indoor | Keeps flashing | 1-time flash | |
| | Outdoor | – | Stays OFF | |

| | | | |
|---|---|-----------------------|--|
| 1.Applicable model | 5.Troubleshooting | | |
| All models | Diagnosis | Countermeasure | |
| 2.Error detection method | <pre> graph TD Start[E19 occurs when the power ON] --> Decision{Is SW7-1 on the indoor unit control PCB ON?} Decision -- NO --> Countermeasure1[Defective indoor unit control PCB (Defective SW7) -> Replace.] Decision -- YES --> Countermeasure2[Turn SW7-1 on the indoor unit control PCB OFF and reset the power.] </pre> | | |
| After indoor operation check, when the communication between indoor and outdoor unit is established and SW7-1 is still kept ON. | | | |
| 3.Condition of error displayed | | | |
| Same as above | | | |
| 4.Presumable cause | | | |
| Mistake in SW7-1 setting (Due to forgetting to turn OFF SW7-1 after indoor operation check) | | | |

Note:

| | | | | |
|-----------------------------------|---------|----------------|--------------|---|
| Error code Remote control: E20 | LED | Green | Red | Content Indoor fan motor rotation speed anomaly |
| | Indoor | Keeps flashing | 1-time flash | |
| | Outdoor | — | Stays OFF | |

1. Applicable model
All models

2. Error detection method
Detected by rotation speed of indoor fan motor

3. Condition of error displayed
When the actual fan rotation speed does not reach to the speed of [required speed -50 min⁻¹] after 2 minutes have been elapsed since the fan motor rotation speed command was output, the unit stops by detecting indoor fan motor anomaly.

- 4. Presumable cause**
- Defective indoor unit control PCB
 - Foreign material at rotational area of fan propeller
 - Defective fan motor
 - Dust on indoor unit control PCB
 - Blown fuse
 - External noise, surge

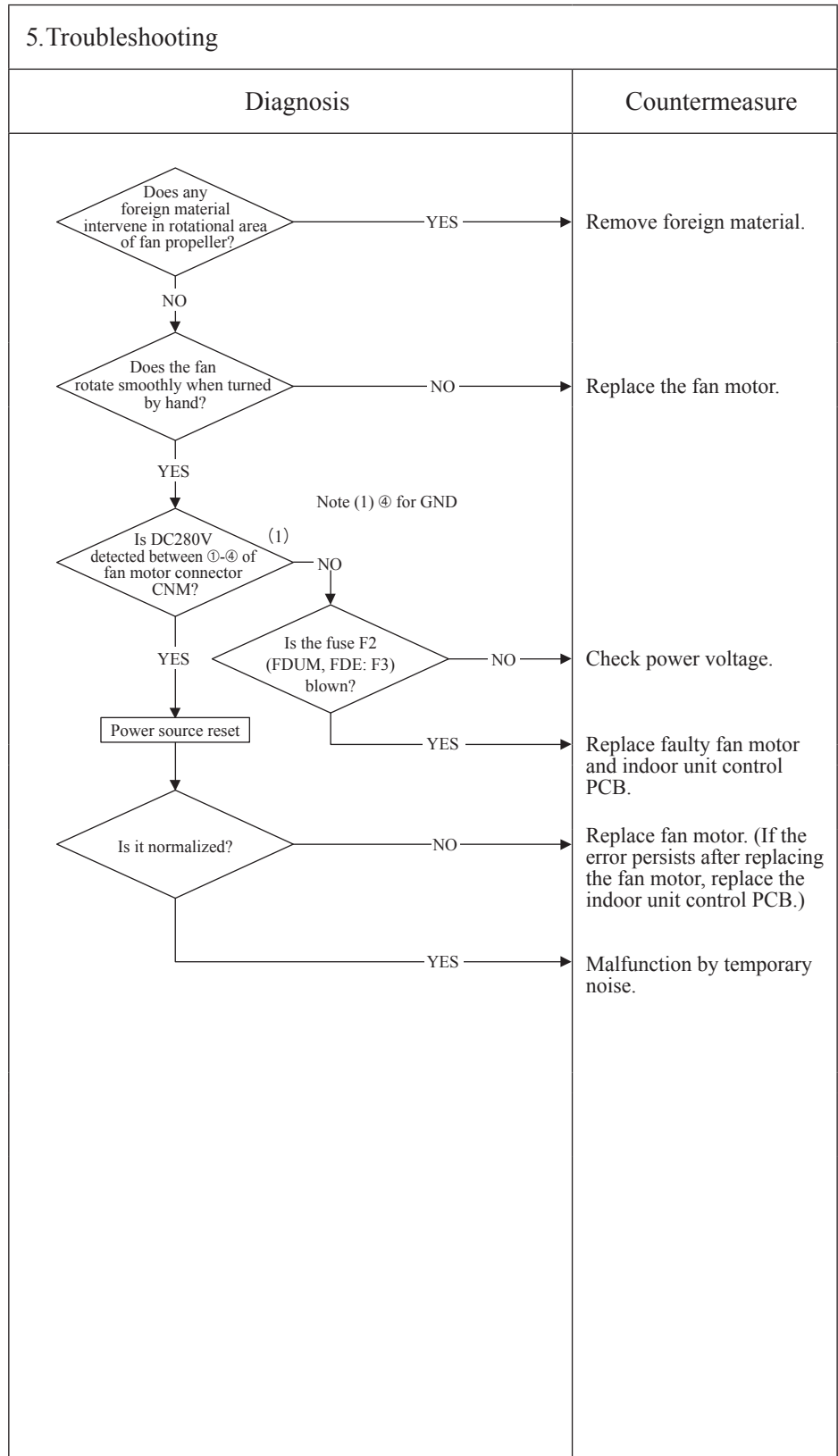

Note:

| | | | | |
|-----------------------------------|---------|----------------|-----------|---|
| Error code Remote control: E28 | LED | Green | Red | Content Remote control temperature sensor anomaly |
| | Indoor | Keeps flashing | Stays OFF | |
| | Outdoor | – | Stays OFF | |

1. Applicable model
All models

2. Error detection method
Detection of anomalously low temperature (resistance) of remote control temperature sensor (The)

3. Condition of error displayed
When the temperature sensor detects -50°C or lower for 5 seconds continuously, the compressor stops. After 3-minute delay, the compressor starts again automatically, but if this error occurs again within 60 minutes after the initial detection.

4. Presumable cause

- Faulty connection of remote control temperature sensor
- Defective remote control temperature sensor
- Defective remote control PCB

5. Troubleshooting

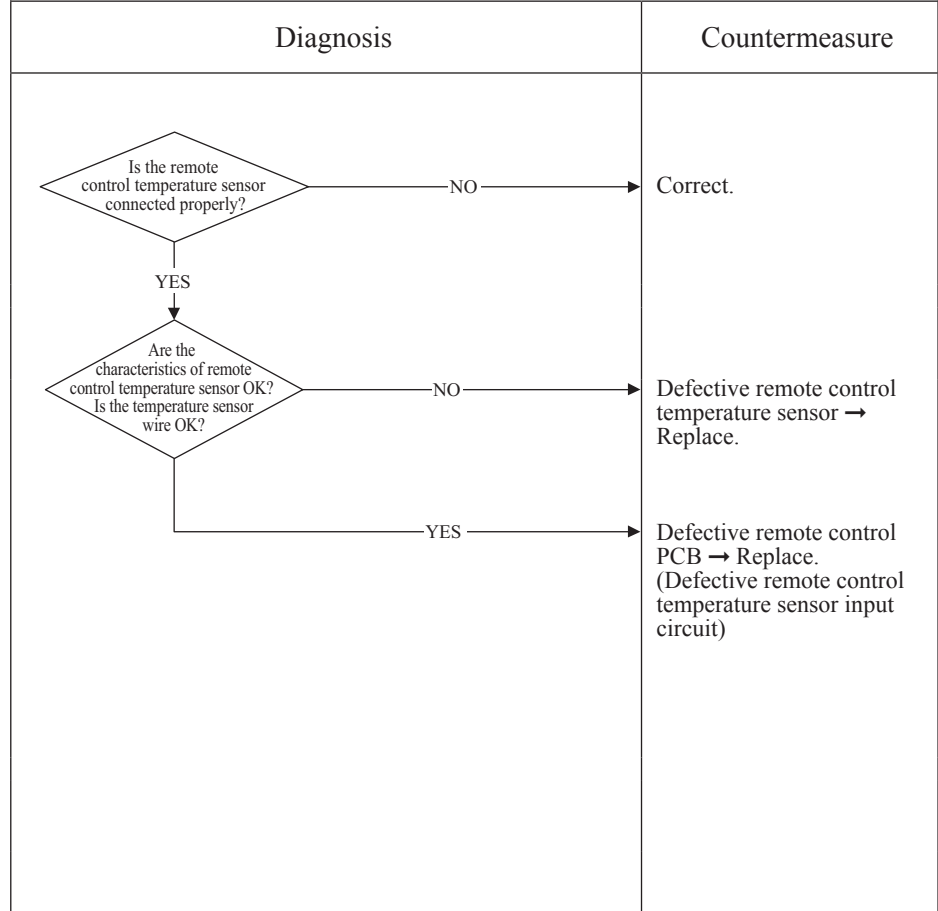

Resistance-temperature characteristics of remote control temperature sensor (The)

| Temperature (°C) | Resistance value (kΩ) | Temperature (°C) | Resistance value (kΩ) |
|------------------|-----------------------|------------------|-----------------------|
| 0 | 65 | 30 | 16 |
| 1 | 62 | 32 | 15 |
| 2 | 59 | 34 | 14 |
| 4 | 53 | 36 | 13 |
| 6 | 48 | 38 | 12 |
| 8 | 44 | 40 | 11 |
| 10 | 40 | 42 | 9.9 |
| 12 | 36 | 44 | 9.2 |
| 14 | 33 | 46 | 8.5 |
| 16 | 30 | 48 | 7.8 |
| 18 | 27 | 50 | 7.3 |
| 20 | 25 | 52 | 6.7 |
| 22 | 23 | 54 | 6.3 |
| 24 | 21 | 56 | 5.8 |
| 26 | 19 | 58 | 5.4 |
| 28 | 18 | 60 | 5.0 |

Note: After 10 seconds has passed since remote control temperature sensor was switched from valid to invalid, E28 will not be displayed even if the sensor harness is disconnected. At same time the sensor, which is effective, is switched from remote control temperature sensor to indoor return air temperature sensor. Even though the remote control temperature sensor is set to be Effective, the return air temperature displayed on remote control for checking still shows the value detected by indoor return air temperature sensor, not by remote control temperature sensor.

| | | | | |
|-----------------------------------|---------|----------------|--------------|---|
| Error code Remote control: E35 | LED | Green | Red | Content Cooling high pressure operation |
| | Indoor | Keeps flashing | Stays OFF | |
| | Outdoor | — | 2-time flash | |

1. Applicable model
All models

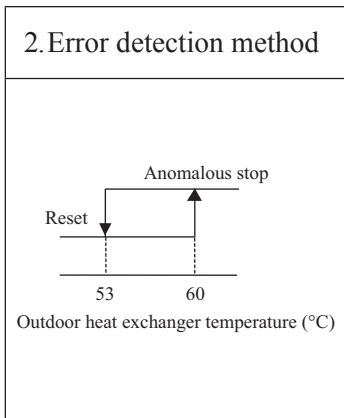

3. Condition of error displayed
When anomalous outdoor heat exchanger temperature occurs 5 times within 60 minutes or 60°C or higher continues for 10 minutes, including the compressor stop.

- 4. Presumable cause**
- Defective outdoor heat exchanger temperature sensor
 - Defective outdoor unit main PCB
 - Indoor, outdoor unit installation spaces
 - Short-circuit of air on indoor, outdoor units
 - Fouling, clogging of heat exchanger
 - Excessive refrigerant quantity

5. Troubleshooting

| Diagnosis | Countermeasure |
|---|--|
| <p>* For the characteristics of outdoor heat exchanger temperature sensor, refer to E37.</p> <p>Are normal the characteristics of outdoor heat exchanger temperature sensor normal?</p> <p>NO →</p> <p>YES →</p> <p>Is the unit operating in the state of cooling overload?</p> <p>NO →</p> <p>YES →</p> <p>Is the high pressure control normal?</p> <p>NO →</p> <p>YES →</p> <p>Is the temperature (measured actually) at direction of error correct?</p> <p>NO →</p> <p>YES →</p> | <p>Replace outdoor heat exchanger temperature sensor.</p> <p>Check unit side.</p> <ul style="list-style-type: none"> • Isn't the air circulation of outdoor unit short-circuited? • Are installation spaces adequate? • Isn't there any fouling or clogging on heat exchanger? <p>Control operation check*.</p> <p>Defective outdoor unit main PCB → Replace.</p> <p>Excessive refrigerant amount: Recharge refrigerant by weighing proper amount on a scale.</p> |

* For the contents of control, refer to the protective control by controlling compressor rotation speed and cooling high pressure protective control of microcomputer control function for corresponding models.

Note:

| | | | | | |
|-----------------------------------|---------|----------------|--------------|---------|---|
| Error code Remote control: E36 | LED | Green | Red | Content | Discharge pipe temperature error |
| | Indoor | Keeps flashing | Stays OFF | | |
| | Outdoor | — | 5-time flash | | |

| |
|----------------------------|
| 1. Applicable model |
| All models |

| |
|--|
| 2. Error detection method |
| For the error detection method, refer to the protective control by controlling compressor rotation speed and cooling high pressure protective control of micro-computer control function for corresponding models. |

| |
|--|
| 3. Condition of error displayed |
| When discharge pipe temperature anomaly is detected 2 times within 60 minutes or this anomalous state is detected 60 minutes continuously including compressor stop. |

| |
|--|
| 4. Presumable cause |
| <ul style="list-style-type: none"> • Defective outdoor unit main PCB • Defective discharge pipe temperature sensor • Clogged filter • Indoor, outdoor unit installation spaces • Short-circuit of air on indoor, outdoor units • Fouling, clogging of heat exchanger |

| | |
|---|-----------------------|
| 5. Troubleshooting | |
| Diagnosis | Countermeasure |
| <p style="text-align: right;">* For the characteristics of discharge pipe temperature, refer to E39.</p> <pre> graph TD D1{Are the characteristics of discharge pipe temperature sensor normal?} D2{Is the discharge pipe temperature error persisted during cooling operation?} D3{Is the discharge pipe temperature control normal?} D4{Is the temperature (measured actually) at detection of error correct?} D1 -- NO --> C1[Replace discharge pipe temperature sensor.] D1 -- YES --> D2 D2 -- YES --> C2[Insufficient refrigerant amount : Recharge refrigerant by weighing proper amount on a scale.] D2 -- NO --> D3 D3 -- NO --> C3[Control operation check *.] D3 -- YES --> D4 D4 -- NO --> C4[Defective outdoor unit main PCB -> Replace.] D4 -- YES --> C5[Check unit side: • Isn't filter clogged? • Are adequate indoor, outdoor unit installation spaces? • Isn't there any short-circuit of air? • Isn't there any fouling, clogging on indoor heat exchanger?] </pre> | |
| <p>* For the contents of control, refer to the protective control by controlling compressor rotation speed and cooling high pressure protective control of microcomputer control function for corresponding models.</p> | |

Note:

| | | | | |
|-----------------------------------|---------|----------------|--------------|---|
| Error code Remote control: E37 | LED | Green | Red | Content Outdoor heat exchanger temperature sensor anomaly |
| | Indoor | Keeps flashing | Stays OFF | |
| | Outdoor | — | 8-time flash | |

| |
|---------------------------|
| 1.Applicable model |
| All models |

| |
|--|
| 2. Error detection method |
| Detection of anomalously low temperature (resistance) on the outdoor heat exchanger temperature sensor |

| |
|--|
| 3. Condition of error displayed |
| <ul style="list-style-type: none"> When the temperature sensor detects -55°C or lower for 20 seconds continuously within 2 minutes to 2 minutes 20 seconds after the compressor ON, the compressor stops. After 3-minutes delay, the compressor starts again automatically, but if this anomalous temperature is detected 3 times within 40 minutes. When -55°C or lower is detected for 5 seconds continuously within 20 seconds after compressor ON. |

| |
|--|
| 4. Presumable cause |
| <ul style="list-style-type: none"> Defective outdoor unit main or sub PCB Broken sensor harness or temperature sensing section Disconnected wire connection (connector) |

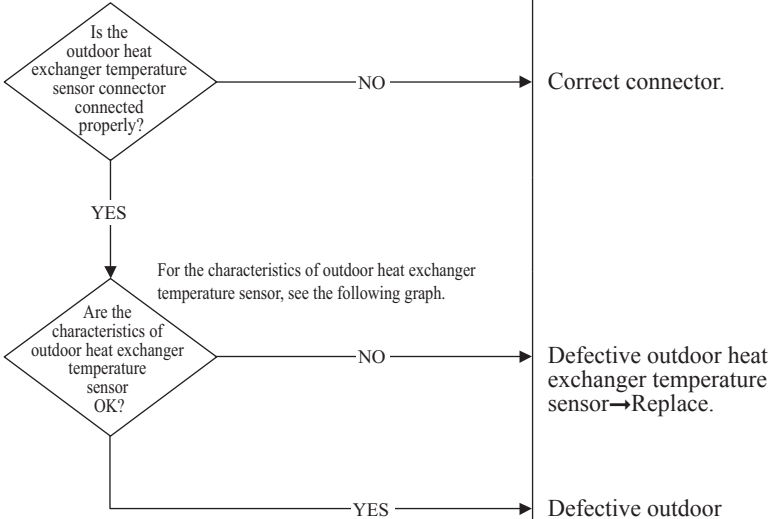
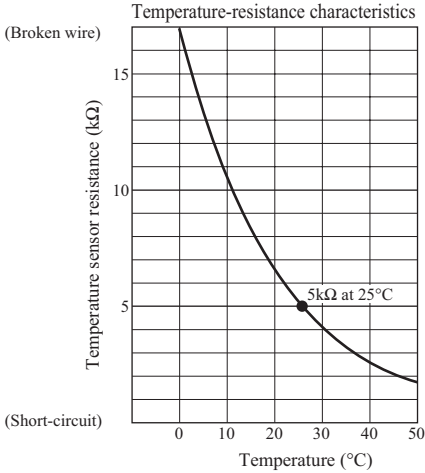
| | |
|--|-----------------------|
| 5. Troubleshooting | |
| Diagnosis | Countermeasure |
|  <pre> graph TD Q1{Is the outdoor heat exchanger temperature sensor connector connected properly?} Q2{Are the characteristics of outdoor heat exchanger temperature sensor OK?} C1[Correct connector.] C2[Defective outdoor heat exchanger temperature sensor -> Replace.] C3[Defective outdoor unit main or sub PCB -> Replace. (Defective outdoor heat exchanger temperature sensor input circuit)] Q1 -- NO --> C1 Q1 -- YES --> Q2 Q2 -- NO --> C2 Q2 -- YES --> C3 </pre> | |
| <p style="text-align: center;">Temperature-resistance characteristics</p>  <p style="text-align: center;">Temperature sensor resistance (kΩ)</p> <p style="text-align: center;">Temperature (°C)</p> | |

Note:

| | | | | |
|--|----------------|----------------|--------------|--|
| Error code Remote control: E38 | LED | Green | Red | Content Outdoor air temperature sensor anomaly |
| | Indoor | Keeps flashing | Stays OFF | |
| | Outdoor | — | 8-time flash | |

| |
|----------------------------|
| 1. Applicable model |
| All models |

| |
|---|
| 2. Error detection method |
| Detection of anomalously low temperature (resistance) on outdoor air temperature sensor |

| |
|---|
| 3. Condition of error displayed |
| <ul style="list-style-type: none"> When the temperature sensor detects -55°C or lower for 5 seconds continuously within 2 minutes to 2 minutes 20 seconds after the compressor ON, the compressor stops. After 3-minutes delay, the compressor starts again automatically, but if this anomalous temperature is detected 3 times within 40 minutes. When -55°C or lower is detected for 5 seconds continuously within 20 seconds after compressor ON. |

| |
|--|
| 4. Presumable cause |
| <ul style="list-style-type: none"> Defective outdoor unit main PCB Broken sensor harness or temperature sensing section (Check molding.) Disconnected wire connection (connector) |

| 5. Troubleshooting | | | | | | | | | | | | | | | | | |
|---|------------------------------------|------------------|------------------------------------|---|-----|----|-----|----|----|----|-----------------|----|----|----|----|----|----|
| Diagnosis | Countermeasure | | | | | | | | | | | | | | | | |
| <pre> graph TD A{Is the outdoor air temperature sensor connector connected properly?} -- NO --> B[Correct connector.] A -- YES --> C{Is the characteristics of the outdoor air temperature sensor OK?} C -- NO --> D[Defective outdoor air temperature sensor → Replace.] C -- YES --> E[Defective outdoor unit main PCB → Replace. (Defective outdoor air temperature sensor input circuit)] </pre> | | | | | | | | | | | | | | | | | |
| <p style="text-align: center;">Temperature-resistance characteristics</p> <p>(Broken wire) (Short-circuit)</p> <table border="1"> <caption>Temperature-resistance characteristics data</caption> <thead> <tr> <th>Temperature (°C)</th> <th>Temperature sensor resistance (kΩ)</th> </tr> </thead> <tbody> <tr> <td>0</td> <td>~15</td> </tr> <tr> <td>10</td> <td>~10</td> </tr> <tr> <td>20</td> <td>~6</td> </tr> <tr> <td>25</td> <td>5 (5kΩ at 25°C)</td> </tr> <tr> <td>30</td> <td>~4</td> </tr> <tr> <td>40</td> <td>~3</td> </tr> <tr> <td>50</td> <td>~2</td> </tr> </tbody> </table> | | Temperature (°C) | Temperature sensor resistance (kΩ) | 0 | ~15 | 10 | ~10 | 20 | ~6 | 25 | 5 (5kΩ at 25°C) | 30 | ~4 | 40 | ~3 | 50 | ~2 |
| Temperature (°C) | Temperature sensor resistance (kΩ) | | | | | | | | | | | | | | | | |
| 0 | ~15 | | | | | | | | | | | | | | | | |
| 10 | ~10 | | | | | | | | | | | | | | | | |
| 20 | ~6 | | | | | | | | | | | | | | | | |
| 25 | 5 (5kΩ at 25°C) | | | | | | | | | | | | | | | | |
| 30 | ~4 | | | | | | | | | | | | | | | | |
| 40 | ~3 | | | | | | | | | | | | | | | | |
| 50 | ~2 | | | | | | | | | | | | | | | | |

Note:

| | | | | |
|--|------------|----------------|--------------|--|
| Error code Remote control: E39 | LED | Green | Red | Content <h2 style="text-align: center;">Discharge pipe temperature sensor anomaly</h2> |
| | Indoor | Keeps flashing | Stays OFF | |
| | Outdoor | — | 8-time flash | |

| |
|----------------------------|
| 1. Applicable model |
| All models |

| |
|--|
| 2. Error detection method |
| Detection of anomalously low temperature (resistance) on the discharge pipe temperature sensor |

| |
|---|
| 3. Condition of error displayed |
| When the temperature sensor detects -25°C or lower for 5 seconds continuously within 10 minutes to 10 minutes 20 seconds after the compressor ON, the compressor stops. After 3-minute delay, the compressor starts again automatically, but if this anomalous temperature is detected 3 times within 40 minutes. |

| |
|--|
| 4. Presumable cause |
| <ul style="list-style-type: none"> • Defective outdoor unit main PCB • Broken sensor harness or temperature sensing section (Check molding.) • Disconnected wire connection (connector) |

| 5. Troubleshooting | | | | | | | | | | | | | | | | | | | | | | | |
|--|------------------------------------|------------------|------------------------------------|----|-----|----|----|----|----|----|----|----|----|----|----|----|----|-----|----|-----|---|-----|---|
| Diagnosis | Countermeasure | | | | | | | | | | | | | | | | | | | | | | |
| <pre> graph TD Q1{Is the discharge pipe temperature sensor connector connected properly?} -- NO --> C1[Correct connector.] Q1 -- YES --> Q2{Are the characteristics of discharge pipe temperature sensor OK?} Q2 -- NO --> C2[Defective discharge pipe temperature sensor -> Replace.] Q2 -- YES --> C3[Defective outdoor unit main PCB -> Replace. (Defective temperature sensor input circuit)] </pre> | | | | | | | | | | | | | | | | | | | | | | | |
| <p>(Broken wire) Temperature-resistance characteristics</p> <table border="1"> <caption>Temperature-resistance characteristics (Approximate values)</caption> <thead> <tr> <th>Temperature (°C)</th> <th>Temperature sensor resistance (kΩ)</th> </tr> </thead> <tbody> <tr><td>10</td><td>100</td></tr> <tr><td>20</td><td>60</td></tr> <tr><td>30</td><td>40</td></tr> <tr><td>40</td><td>30</td></tr> <tr><td>50</td><td>25</td></tr> <tr><td>60</td><td>20</td></tr> <tr><td>80</td><td>15</td></tr> <tr><td>100</td><td>10</td></tr> <tr><td>120</td><td>8</td></tr> <tr><td>140</td><td>6</td></tr> </tbody> </table> <p>[T ≦ 90°C] (Short-circuit)</p> | | Temperature (°C) | Temperature sensor resistance (kΩ) | 10 | 100 | 20 | 60 | 30 | 40 | 40 | 30 | 50 | 25 | 60 | 20 | 80 | 15 | 100 | 10 | 120 | 8 | 140 | 6 |
| Temperature (°C) | Temperature sensor resistance (kΩ) | | | | | | | | | | | | | | | | | | | | | | |
| 10 | 100 | | | | | | | | | | | | | | | | | | | | | | |
| 20 | 60 | | | | | | | | | | | | | | | | | | | | | | |
| 30 | 40 | | | | | | | | | | | | | | | | | | | | | | |
| 40 | 30 | | | | | | | | | | | | | | | | | | | | | | |
| 50 | 25 | | | | | | | | | | | | | | | | | | | | | | |
| 60 | 20 | | | | | | | | | | | | | | | | | | | | | | |
| 80 | 15 | | | | | | | | | | | | | | | | | | | | | | |
| 100 | 10 | | | | | | | | | | | | | | | | | | | | | | |
| 120 | 8 | | | | | | | | | | | | | | | | | | | | | | |
| 140 | 6 | | | | | | | | | | | | | | | | | | | | | | |

Note:

| | | | | |
|-----------------------------------|---------|----------------|--------------|---|
| Error code Remote control: E40 | LED | Green | Red | Content Service valve (gas side) closing operation |
| | Indoor | Keeps flashing | Stays OFF | |
| | Outdoor | — | 4-time flash | |

| |
|----------------------------|
| 1. Applicable model |
| All models |

| |
|---|
| 2. Error detection method |
| If the inverter output current value exceeds the setting value within 80 seconds after the compressor ON in the heating mode, the compressor stops. |

| |
|---|
| 3. Condition of error displayed |
| <ul style="list-style-type: none"> • If the output current of inverter exceeds the specifications, it makes the compressor stopping. (In heating mode) • After 3-minute delay, the compressor restarts, but if this anomaly occurs 2 times within 20 minutes after the initial detection. |

| |
|---|
| 4. Presumable cause |
| <ul style="list-style-type: none"> • Service valve (gas side) closing • Defective outdoor unit main PCB |

| | |
|--|-----------------------|
| 5. Troubleshooting | |
| Diagnosis | Countermeasure |
| <pre> graph TD Q1{Are the service valve (gas side) opened?} -- NO --> C1[Open the service valve.] Q1 -- YES --> Q2{Is the checked result of power transistor module OK?} Q2 -- NO --> C2[Defective outdoor unit main PCB -> Replace.] Q2 -- YES --> Q3{After resetting power for several times does it become normal?} subgraph Checks [] C3[Is the space for installation of indoor and/or outdoor unit enough?] C4[Is there any short-circuit of air on indoor and/or outdoor unit?] C5[At heating, does the indoor fan motor run?] C6[Is the filter clogged?] C7[Is there any liquid flooding?] C8[Is there any anomalous sound on the compressor?] end Q3 -- NO --> C2 Q3 -- YES --> N1[Temporary noise may cause of anomaly. If noise source can be found, take countermeasure.] </pre> | |

Note:

| | | | | |
|-----------------------------------|---------|----------------|--------------|-------------------------------------|
| Error code Remote control: E42 | LED | Green | Red | Content Current cut (1/2) |
| | Indoor | Keeps flashing | Stays OFF | |
| | Outdoor | — | 1-time flash | |

1. Applicable model
All models

2. Error detection method
In order to prevent from overcurrent of inverter, if the current exceeds the specifications, it makes the compressor stopping.

3. Condition of error displayed
• If the output current of inverter exceeds the specifications, it makes the compressor stopping.

4. Presumable cause

- The valves closed
- Faulty power source
- Insufficient refrigerant amount
- Faulty compressor
- Faulty power transistor module

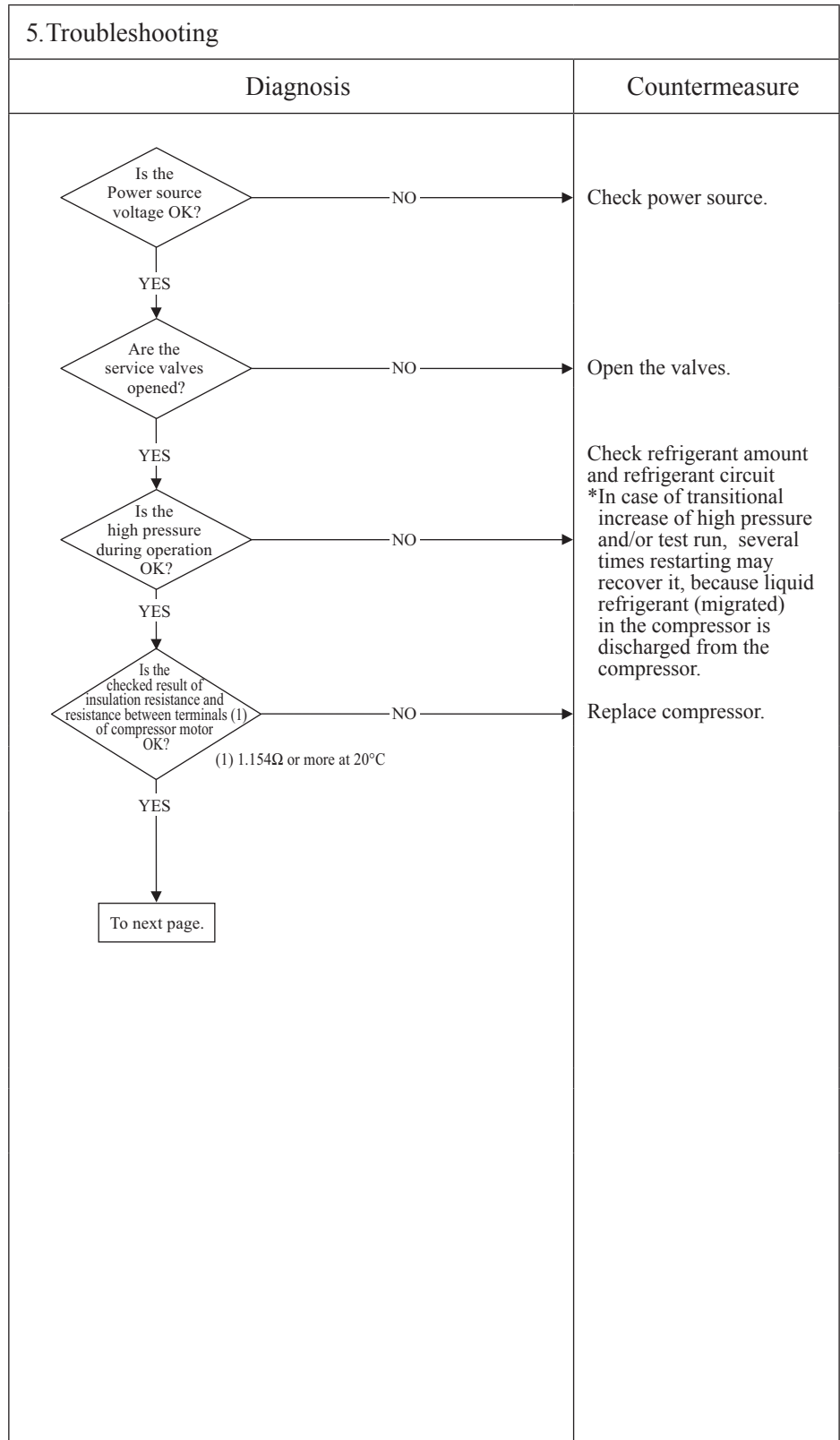

Note:

| | | | | |
|-----------------------------------|---------|----------------|--------------|-------------------------------------|
| Error code Remote control: E42 | LED | Green | Red | Content Current cut (2/2) |
| | Indoor | Keeps flashing | Stays OFF | |
| | Outdoor | — | 1-time flash | |

| |
|--|
| 1. Applicable model |
| All models |
| 2. Error detection method |
| In order to prevent from overcurrent of inverter, if the current exceeds the specifications, it makes the compressor stopping. |
| 3. Condition of error displayed |
| • If the output current of inverter exceeds the specifications, it makes the compressor stopping. |
| 4. Presumable cause |
| <ul style="list-style-type: none"> • Defective outdoor unit main PCB • Faulty power source • Insufficient refrigerant amount • Faulty compressor • Faulty power transistor module |

| | |
|---------------------------|-----------------------|
| 5. Troubleshooting | |
| Diagnosis | Countermeasure |
| | |

Note:

| | | | | |
|-----------------------------------|---------|----------------|--------------|--|
| Error code Remote control: E45 | LED | Green | Red | Content Outdoor unit sub PCB communication error |
| | Indoor | Keeps flashing | Stays OFF | |
| | Outdoor | — | 4-time flash | |

| | | | |
|---|---|-----------------------|--|
| 1. Applicable model | 5. Troubleshooting | | |
| All models | Diagnosis | Countermeasure | |
| 2. Error detection method Detected communication error of more than 15 seconds 4 times in 15 minutes. | <pre> graph TD D1{Is the connector connection between the outdoor unit main PCB and the outdoor sub PCB OK?} D2{Is the power source voltage OK?} D3{Is the communication wire between the main PCB and the outdoor unit sub PCB connected properly?} P1[Replace the outdoor unit main PCB.] D4{Is normal state restored?} D1 -- NO --> C1[Correct connector.] D1 -- YES --> D2 D2 -- NO --> C2[Check why power is not supplied to outdoor unit sub PCB.] D2 -- YES --> D3 D3 -- NO --> C3[Connect communication wire securely.] D3 -- YES --> P1 P1 --> D4 D4 -- NO --> C4[Defective outdoor unit sub PCB → Replace.] D4 -- YES --> C5[Malfunction by temporary noise] </pre> | | |
| 3. Condition of error displayed When communication is not established between the outdoor unit sub PCB and the outdoor main PCB. | | | |
| 4. Presumable cause <ul style="list-style-type: none"> • Defective outdoor unit sub PCB • Defective connector between the outdoor unit main PCB and outdoor unit sub PCB • Defective outdoor unit main PCB | | | |

Note:

| | | | | |
|-----------------------------------|---------|----------------|--------------|---|
| Error code Remote control: E47 | LED | Green | Red | Content Active filter voltage error |
| | Indoor | Keeps flashing | Stays OFF | |
| | Outdoor | — | 2-time flash | |

| |
|----------------------------|
| 1. Applicable model |
| All models |

| |
|---|
| 2. Error detection method |
| Error is displayed if the converter voltage exceeds DC340V (3 times within 20 minutes). Remote control may be set after 3-minute delay. |

| |
|--|
| 3. Condition of error displayed |
| Same as above |

| |
|--|
| 4. Presumable cause |
| <ul style="list-style-type: none"> • Defective outdoor unit sub PCB • Dust on outdoor unit sub PCB • Anomalous power source |

| | |
|---|-----------------------|
| 5. Troubleshooting | |
| Diagnosis | Countermeasure |
| <pre> graph TD A{Is the power source normal?} -- NO --> B[Restore normal condition.] A -- YES --> C{Is voltage within the specified range?} C -- NO --> D[Restore normal condition.] C -- YES --> E{Check soldered surfaces on the outdoor unit sub PCB for foreign matter like dust, fouling, etc.} E -- NO --> F[Remove foreign matter like dust, fouling, etc.] E -- YES --> G[Defective outdoor unit sub PCB -> Replace.] </pre> | |
| <p>• If the overvoltage (DC voltage is higher than 400V) occurs, the system shut down to protect the unit.</p> | |

Note:

| | | | | |
|-----------------------------------|---------|----------------|-----------|---|
| Error code Remote control: E48 | LED | Green | Red | Content Outdoor fan motor anomaly |
| | Indoor | Keeps flashing | Stays OFF | |
| | Outdoor | – | ON | |

| |
|----------------------------|
| 1. Applicable model |
| All models |

| |
|---|
| 2. Error detection method |
| Detected by rotation speed of outdoor fan motor |

| |
|--|
| 3. Condition of error displayed |
| When actual rotation speed of outdoor fan motor drops to 75min ⁻¹ or lower for 30 minutes continuously, the compressor and the outdoor fan motor stop. After 3-minute delay, it starts again automatically, but if this anomaly occurs 3 times within 60 minutes after the initial detection. |

| |
|--|
| 4. Presumable cause |
| <ul style="list-style-type: none"> • Defective outdoor unit main PCB • Foreign material at rotational area of fan propeller • Defective fan motor • Dust on outdoor unit main PCB • Blown F3 fuse |

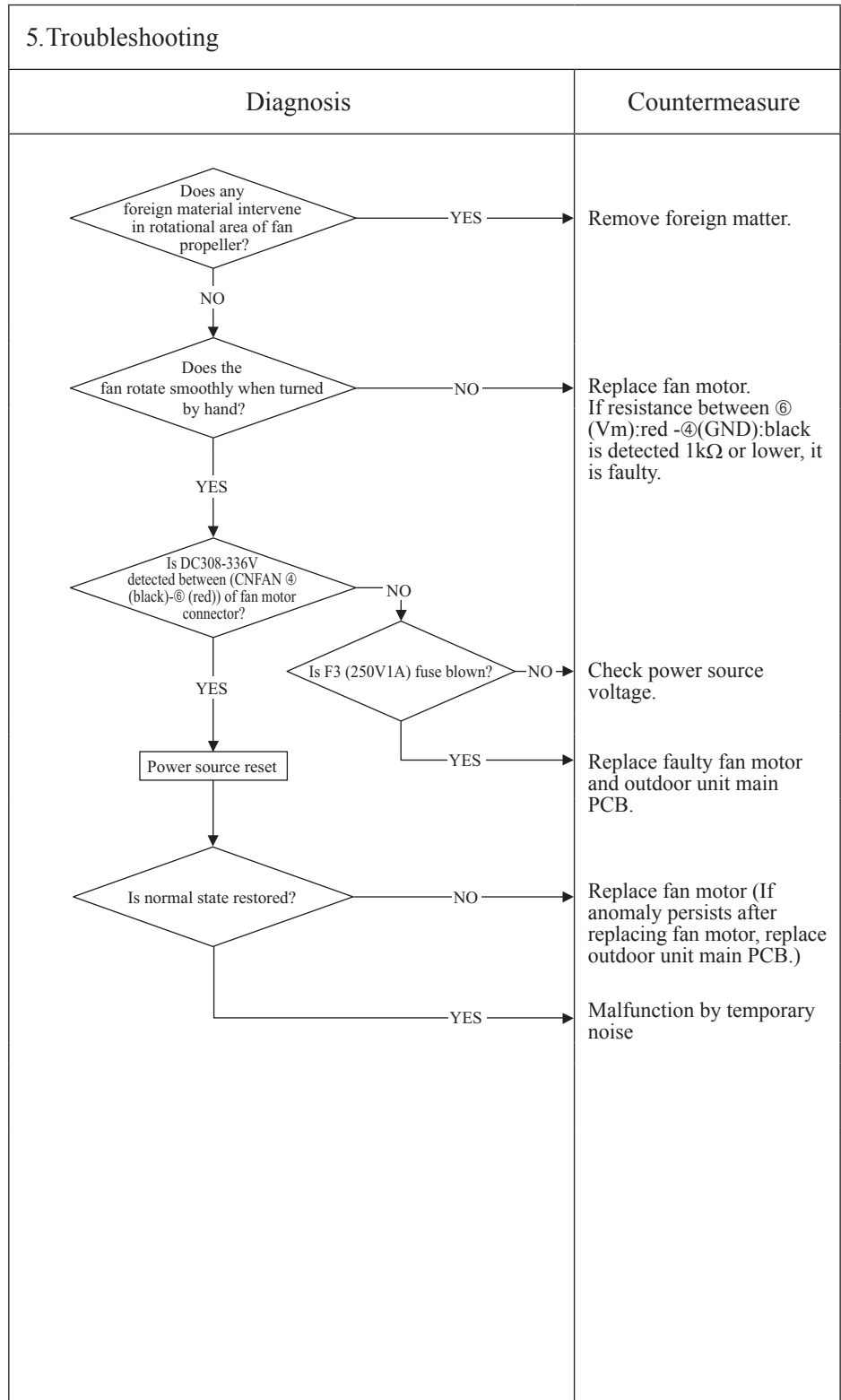

Note: When E48 error occurs, in almost cases F3 fuse (1A) on the outdoor unit main PCB is blown. There are a lot of cases that fuse is blown and E48 occurs due to defective fan motor. And even though only the outdoor unit main PCB (or fuse) is replaced, another trouble could occur. Therefore when fuse is blown, check whether the fan motor is OK or not. After confirming the fan motor normal, check by power ON. (Don't power ON without confirming the fan motor normal.)

| | | | | |
|-----------------------------------|---------|----------------|--------------|--|
| Error code Remote control: E51 | LED | Green | Red | Content Power transistor anomaly |
| | Indoor | Keeps flashing | Stays OFF | |
| | Outdoor | — | 1-time flash | |

| | | |
|---|---|------------------------------|
| <p>1.Applicable model</p> <p>All models</p> | 5.Troubleshooting | |
| <p>2. Error detection method</p> <p>Power transistor primary current</p> | <p>Diagnosis</p> <pre> graph TD A{Check soldered surfaces on the outdoor unit main PCB for foreign matter like dust, fouling, etc.} -- NO --> B[Remove foreign matter like dust, fouling, etc.] A -- YES --> C{Is F8 fuse (250V, 20A) blown?} C -- YES --> D[Replace fuse.] C -- NO --> E[Defective outdoor unit main PCB -> Replace.] </pre> | <p>Countermeasure</p> |
| <p>3. Condition of error displayed</p> <p>If the power transistor primary current exceeds the setting value for 3 seconds, the compressor stops.</p> | | |
| <p>4. Presumable cause</p> <ul style="list-style-type: none"> • Outdoor unit main PCB anomaly • Dust on outdoor unit main PCB • Blown F2 fuse | | |

Note:

| | | | | |
|-----------------------------------|---------|----------------|--------------|---|
| Error code Remote control: E53 | LED | Green | Red | Content Suction pipe temperature sensor anomaly |
| | Indoor | Keeps flashing | Stays OFF | |
| | Outdoor | — | 8-time flash | |

1. Applicable model
All models

2. Error detection method
Detection of anomalously low temperature (resistance) on suction pipe temperature sensor

3. Condition of error displayed

- When the temperature sensor detects -55 °C or lower for 5 seconds continuously within 2 minutes to 2 minutes 20 seconds after the compressor ON, the compressor stops. After 3-minutes delay, the compressor starts again automatically, but if this anomalous temperature is detected 3 times within 40 minutes.
- When -55 °C or lower is detected for within 20 second after power ON.

4. Presumable cause

- Defective outdoor unit sub PCB
- Broken sensor harness or temperature sensing section (Check molding.)
- Disconnected wire connection (connector)

5. Troubleshooting

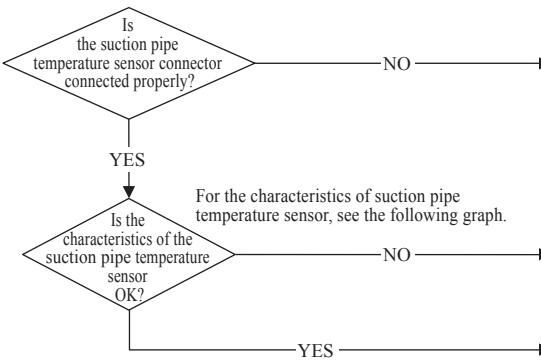
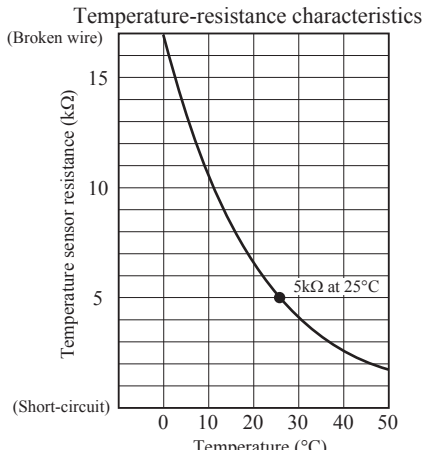
| Diagnosis | Countermeasure |
|--|----------------|
|  <pre> graph TD Q1{Is the suction pipe temperature sensor connector connected properly?} -- NO --> C1[Correct connector.] Q1 -- YES --> Q2{Is the characteristics of the suction pipe temperature sensor OK?} Q2 -- NO --> C2[Defective suction pipe temperature sensor → Replace.] Q2 -- YES --> C3[Defective outdoor unit sub PCB → Replace. (Defective suction pipe temperature sensor input circuit)] </pre> | |
| <p>Temperature-resistance characteristics</p>  | |

Note:

| | | | | |
|-----------------------------------|---------|----------------|--------------|---|
| Error code Remote control: E57 | LED | Green | Red | Content Insufficient refrigerant amount or detection of service valve closure |
| | Indoor | Keeps flashing | Stays OFF | |
| | Outdoor | — | 2-time flash | |

| <p>1. Applicable model</p> <p>All models</p> | <p>5. Troubleshooting</p> <table border="1" style="width: 100%;"> <thead> <tr> <th style="width: 70%;">Diagnosis</th> <th style="width: 30%;">Countermeasure</th> </tr> </thead> <tbody> <tr> <td style="text-align: center;"> </td> <td></td> </tr> </tbody> </table> <p style="text-align: center;">Indoor heat exchanger, return air temperature sensor Temperature-resistance characteristics</p> <p style="text-align: center;">(Broken wire)</p> <p style="text-align: center;">(Short-circuit)</p> | Diagnosis | Countermeasure | | |
|--|--|-----------|----------------|--|--|
| Diagnosis | Countermeasure | | | | |
| | | | | | |
| <p>2. Error detection method</p> <ul style="list-style-type: none"> Judge insufficient refrigerant amount by detecting the temperature difference between indoor heat exchanger (Thi-R) and indoor return air (Thi-A). | | | | | |
| <p>3. Condition of error displayed</p> <p>When the insufficient refrigerant amount is detected 3 times within 60 minutes.</p> | | | | | |
| <p>4. Presumable cause</p> <ul style="list-style-type: none"> Defective indoor heat exchanger temperature sensor Defective indoor return air temperature sensor Defective indoor unit control PCB Insufficient refrigerant amount | | | | | |

Note: When the compressor speed is 60 rps or under at 5 minutes after the start of compressor or the completion of defrost operation, the low refrigerant protection control judges, by detecting the difference between the indoor heat exchanger temperature (Thi-R) and the indoor return air temperature (Thi-A), that it is in the state of gas leakage, and stops the compressor.
 Cooling: Indoor return air temperature (Thi-A) – Indoor heat exchanger temperature (Thi-R) ≤ 4°C
 Heating: Indoor heat exchanger temperature (Thi-R) – Indoor return air temperature (Thi-A) ≤ 6°C

| | | | | |
|-----------------------------------|---------|----------------|--------------|-------------------------------------|
| Error code Remote control: E58 | LED | Green | Red | Content Current safe stop |
| | Indoor | Keeps flashing | Stays OFF | |
| | Outdoor | — | 3-time flash | |

| |
|----------------------------|
| 1. Applicable model |
| All models |

| |
|--|
| 2. Error detection method |
| When the current safe control has operated at the compressor speed of 30 rps or under: |

| |
|--|
| 3. Condition of error displayed |
| Same as above |

| |
|--|
| 4. Presumable cause |
| <ul style="list-style-type: none"> • Excessive refrigerant amount • Indoor, outdoor unit installation spaces • Faulty compressor • Defective outdoor air temperature sensor • Defective outdoor unit main PCB |

| | |
|--|-----------------------|
| 5. Troubleshooting | |
| Diagnosis | Countermeasure |
| <pre> graph TD D1{Is the refrigerant amount normal?} -- NO --> C1[Adjust the refrigerant amount properly.] D1 -- YES --> D2{Is outdoor ventilation condition good?} D2 -- NO --> C2[Secure space for inlet and outlet.] D2 -- YES --> D3{Inspect compressor.} D3 -- NO --> C3[Replace compressor.] D3 -- YES --> D4{Inspect outdoor air temperature sensor.} D4 -- NO --> C4[Replace sensor.] D4 -- YES --> C5[Defective outdoor unit main PCB -> Replace. (Defective outdoor air temperature sensor input circuit)] </pre> | |

Note:

| | | | | |
|-----------------------------------|---------|----------------|--------------|--|
| Error code Remote control: E59 | LED | Green | Red | Content Compressor startup failure |
| | Indoor | Keeps flashing | Stays OFF | |
| | Outdoor | — | 2-time flash | |

| |
|--|
| 1. Applicable model |
| All models |
| 2. Error detection method |
| If it fails to change over to the rotor detection operation of compressor motor |
| 3. Condition of error displayed |
| If compressor fails to startup for 42 times |
| 4. Presumable cause |
| <ul style="list-style-type: none"> • Outdoor fan motor anomaly • Outdoor unit main PCB anomaly • Anomalous power source voltage • Improper refrigerant amount and refrigerant circuit • Faulty compressor (Motor bearing) |

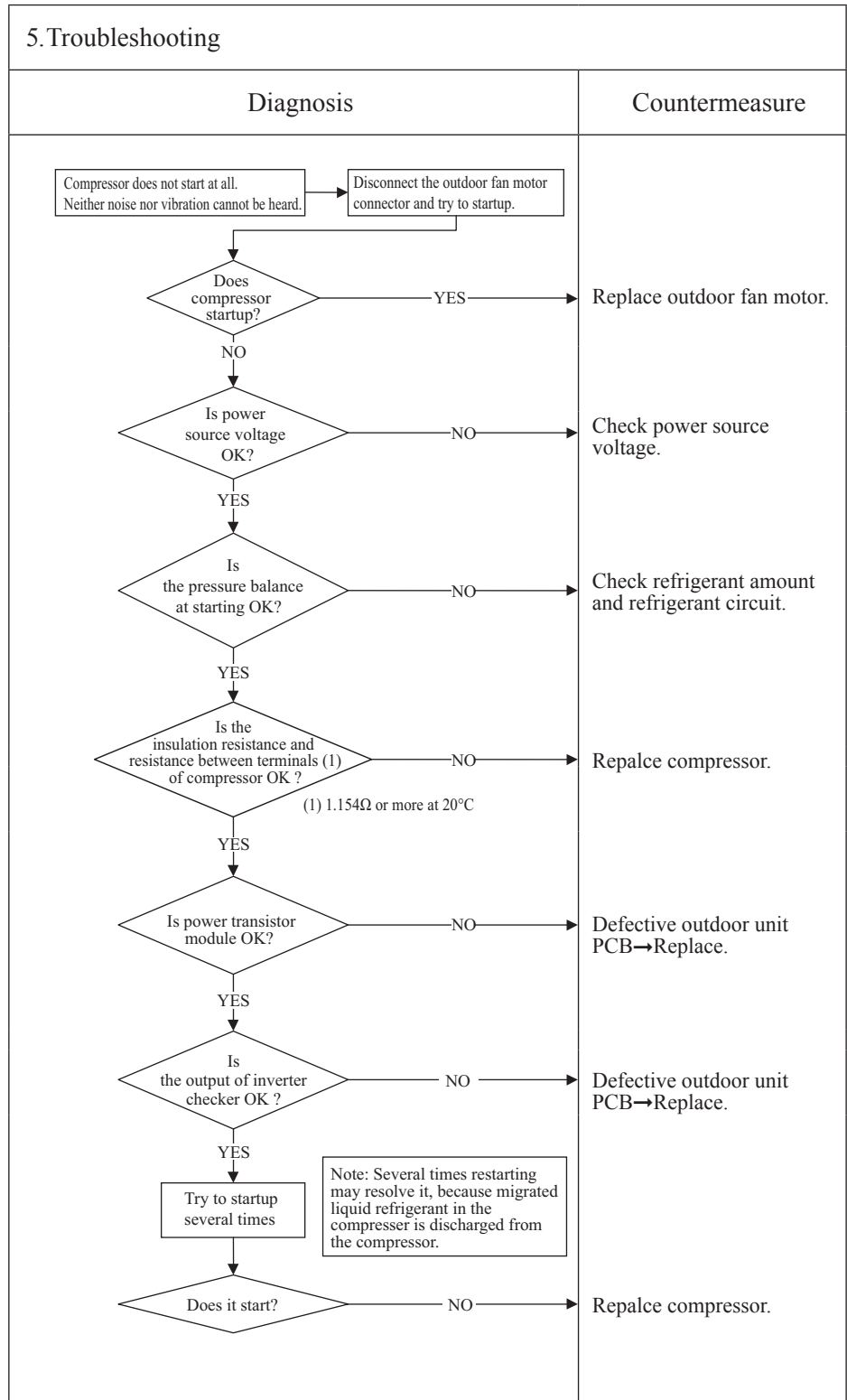

Note: Insulation resistance

- The unit is left for long period without power source or soon after installation, migrated liquid refrigerant may dissolve in the refrigerant oil in the compressor. In such case insulation resistance decreases upto several MΩ or lower. If the electric leakage breaker is activated due to low insulation resistance, check followings.
- ① Check whether the electric leakage breaker conforms to high-harmonic specifications.
(As units has inverter, in order to prevent from improper operation, be sure to use high-harmonic one.)

| | | | | |
|-----------------------------------|---------|----------------|--------------|---|
| Error code Remote control: E60 | LED | Green | Red | Content Compressor rotor lock error |
| | Indoor | Keeps flashing | Stays OFF | |
| | Outdoor | — | 7-time flash | |

| |
|----------------------------|
| 1. Applicable model |
| All models |

| |
|----------------------------------|
| 2. Error detection method |
| Compressor rotor position |

| |
|---|
| 3. Condition of error displayed |
| If it fails again to detect the rotor position after shifting to the compressor rotor position detection operation, the compressor stops. |

| |
|--|
| 4. Presumable cause |
| <ul style="list-style-type: none"> • Defective outdoor fan motor • Defective outdoor unit main PCB • Anomalous power source voltage • Improper refrigerant amount and refrigerant circuit • Defective compressor (motor, bearing) |

| | |
|---|-----------------------|
| 5. Troubleshooting | |
| Diagnosis | Countermeasure |
| <pre> graph TD Q1{Is the power source voltage OK?} -- NO --> C1[Check and correct the power source voltage.] Q1 -- YES --> R1[Reset the power source and restart operation.] R1 --> Q2{Does the compressor start?} Q2 -- NO --> Q3{Does E59 occur?} Q3 -- YES --> C2[Correct it based on the troubleshooting of E59.] Q3 -- NO --> Q4{Does the compressor run without occurrence of E42?} Q4 -- NO --> C3[Correct it based on the troubleshooting of E42.] Q4 -- YES --> Q5{Is the output from inverter checker OK?} Q5 -- NO --> C4[Defective outdoor unit main PCB → Replace.] Q5 -- YES --> Q6{Is the noise or vibration of compressor normal?} Q6 -- NO --> C5[Replace compressor.] Q6 -- YES --> Q7{Does it start up normally without recurrence of E60?} Q7 -- NO --> C6[Check compressor for insulation, resistance. Replace compressor if necessary.] Q7 -- YES --> C7[Defective outdoor unit main PCB → Replace.] </pre> | |

Note: Insulation resistance

- The unit is left for long period without power source or soon after installation, migrated liquid refrigerant may dissolve in the refrigerant oil in the compressor. In such case insulation resistance decreases upto several MΩ or lower. If the electric leakage breaker is activated due to low insulation resistance, check followings.
 - ① Check whether the electric leakage breaker conforms to high-harmonic specifications.
(As units has inverter, in order to prevent from improper operation, be sure to use high-harmonic one.)

3. ELECTRICAL WIRING

(1) Outdoor unit

Models SCM71ZS-W, 80ZS-W

Meaning of marks

| Item | Description | Item | Description |
|--------|----------------|-------------------------------------|-------------------------------------|
| CN20S | Connector | 20S | 4-way valve (coil) |
| CN20V | | CM | Compressor motor |
| CNA | | EEVA,EEVB | Electric expansion valve (coil) |
| CNB | | EEV C,EEV D | |
| CNC | | FMo | Fan motor |
| CND | L | Reactor | |
| CNEEV1 | Terminal block | TB1~5 | Terminal block |
| CNEEV2 | | TH1 (Tho-R1) | Heat exchanger temperature sensor 1 |
| CNFAN | | TH2 (Tho-A) | Outdoor air temperature sensor |
| CNMAIN | | TH3 (Tho-D) | Discharge pipe temperature sensor |
| CNSUB | | TH4 (Tho-S) | Suction pipe temperature sensor |
| CNTH | TH5 (Tho-R2) | Heat exchanger temperature sensor 2 | |

Color marks

| Mark | Color | Mark | Color |
|------|-------|------|--------------|
| BK | Black | RD | Red |
| BL | Blue | WH | White |
| BR | Brown | YE | Yellow |
| GN | Green | YG | Yellow/Green |

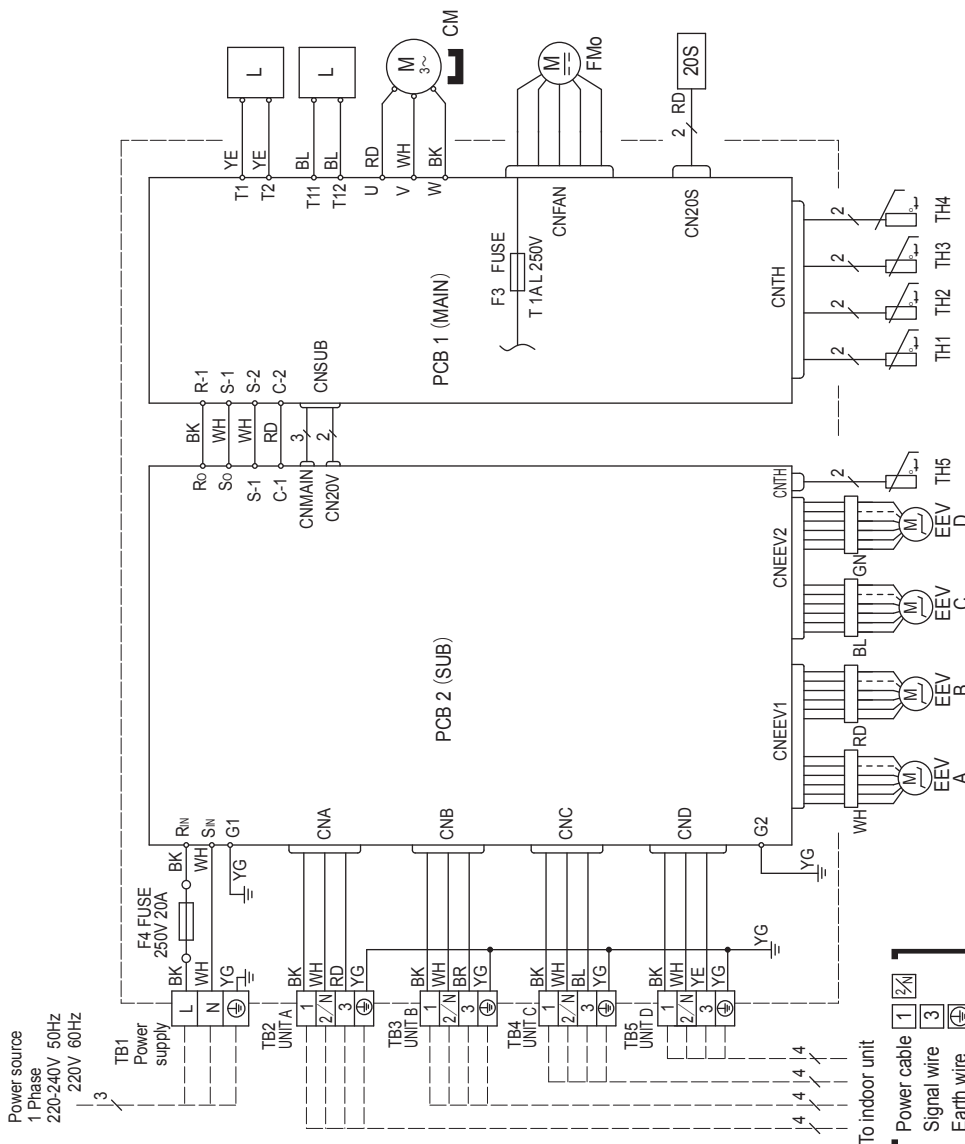

Power cable, indoor-outdoor connecting wires

| Model name | MAX running current (A) | Power cable wire size x number* | Power cable length (m) | Connecting cable wire size x number* |
|------------|-------------------------|---------------------------------|------------------------|--------------------------------------|
| SCM71ZS-W | 20.0 | 2.5mm ² x 3 | 12 | 1.5mm ² x 4 |
| SCM80ZS-W | | | | |

- * The wire numbers include earth wire (Yellow/Green)
- Switchgear or circuit breaker capacity should be chosen according to national or regional electricity regulations.
- The power cable specifications are based on the assumption that a metal or plastic conduit is used with no more than three cables contained in a conduit and a voltage drop is 2%. For an installation falling outside of these conditions, please follow the national or regional electricity regulations.

RWC000Z331

(2) Indoor unit

(a) Wall mounted type (SRK)

- (i) Models SRK20ZSX-W, 25ZSX-W, 35ZSX-W, 50ZSX-W, 60ZSX-W
 SRK20ZSX-WB, 25ZSX-WB, 35ZSX-WB, 50ZSX-WB, 60ZSX-WB
 SRK20ZSX-WT, 25ZSX-WT, 35ZSX-WT, 50ZSX-WT, 60ZSX-WT

| Item | Description |
|------|-------------|
| CNE | Connector |
| CNF | |
| CNG | |
| CNU | |
| CNL | |
| CNM | |
| CNP | |
| CNS | |
| CNU | |
| CNX | |
| CNY | |
| CNZ | |

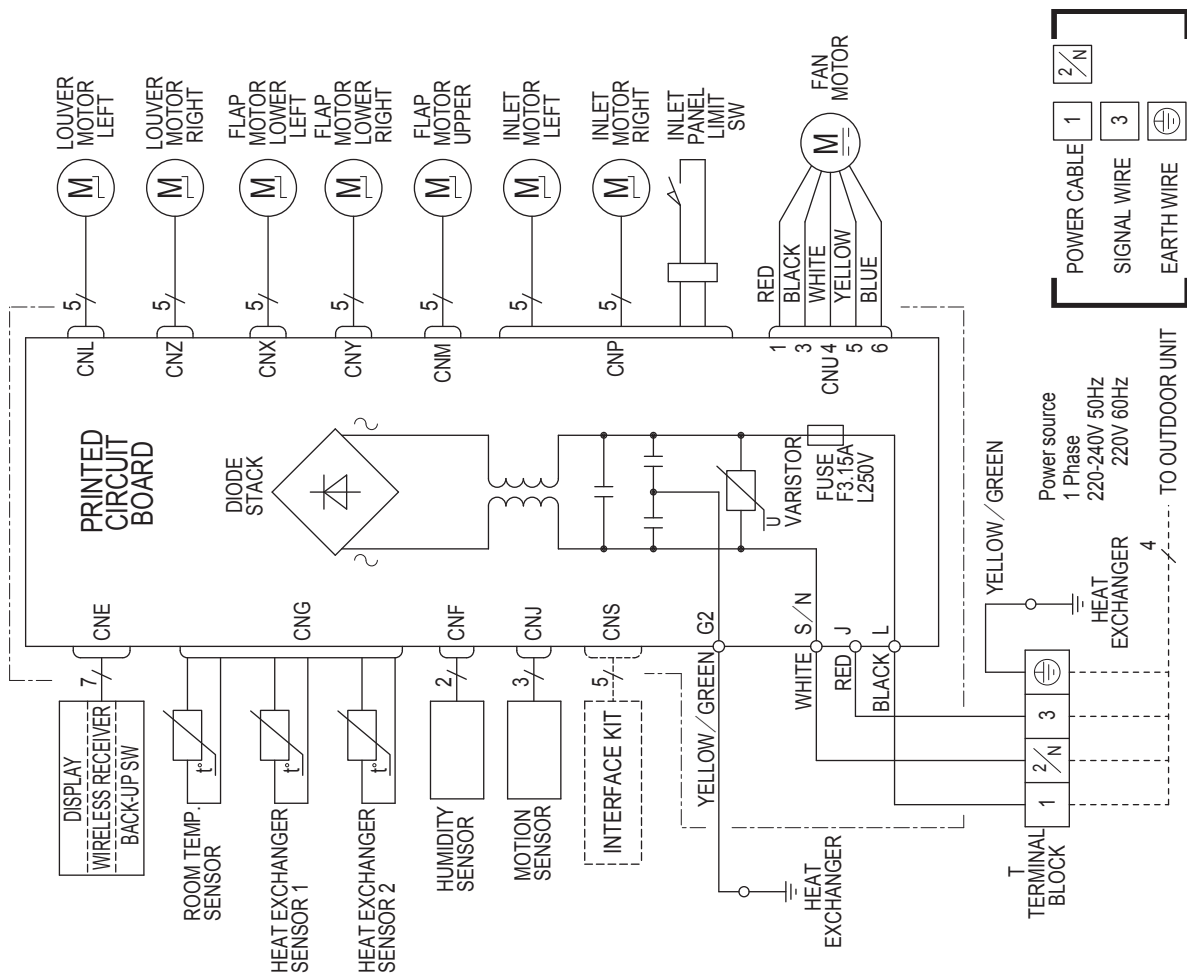

RWA000Z413

(ii) Models SRK20ZS-W, 25ZS-W, 35ZS-W, 50ZS-W
 SRK20ZS-WB, 25ZS-WB, 35ZS-WB, 50ZS-WB
 SRK20ZS-WT, 25ZS-WT, 35ZS-WT, 50ZS-WT

| Item | Description |
|------|-------------|
| CNE | Connector |
| CNF | |
| CNG | |
| CNM | |
| CNS | |
| CNU | |
| CNX | |
| CNY | |

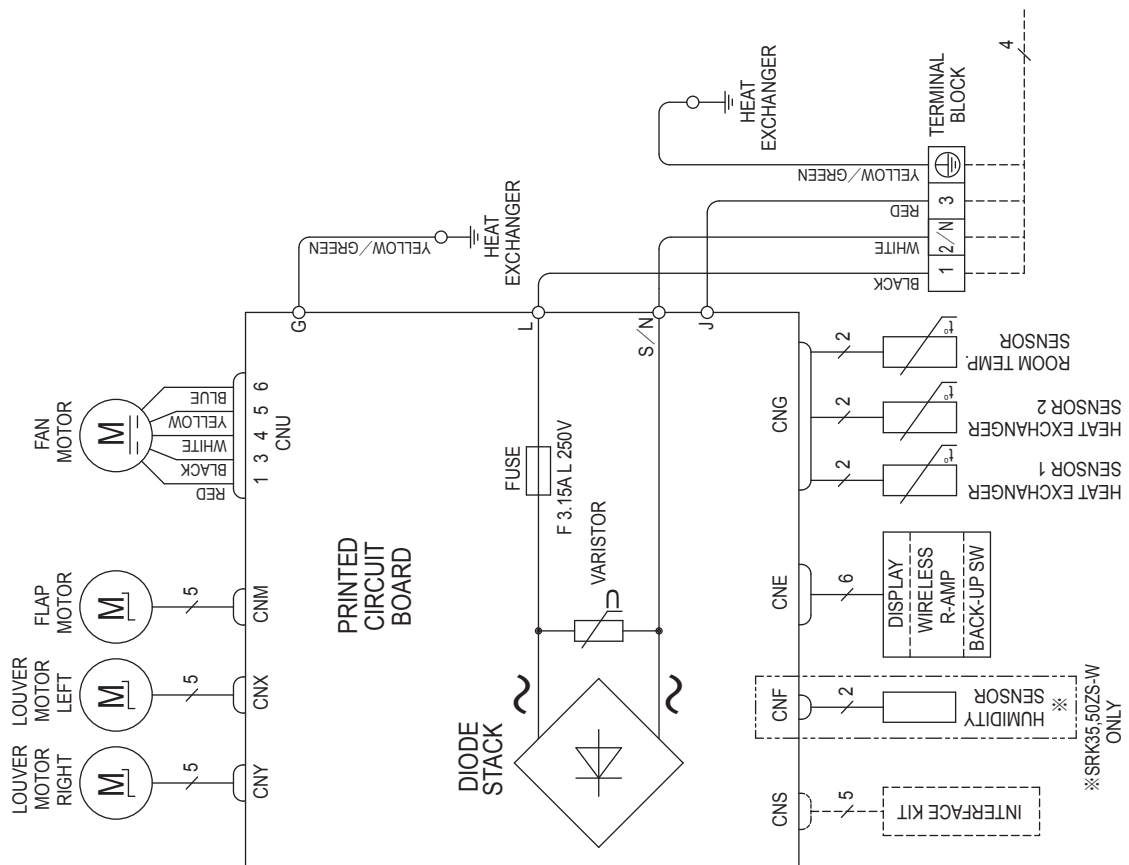

RWA000Z416

(iii) Model SRK71ZR-W

| Item | Description |
|--------------------|-----------------------------------|
| CNE | Connector |
| CNF | |
| CNG | |
| CNM | |
| CNS | |
| CNU | |
| CNX | |
| CNY | |
| FMi | Fan motor |
| SM ₁ | Flap motor |
| LM _{1,2} | Louver motor |
| Th1 | Room temperature sensor |
| Th2 _{1,2} | Heat exchanger temperature sensor |
| Th3 | Humidity sensor |
| DS | Diode stack |
| F | Fuse |
| TB | Terminal block |
| Va | Varistor |

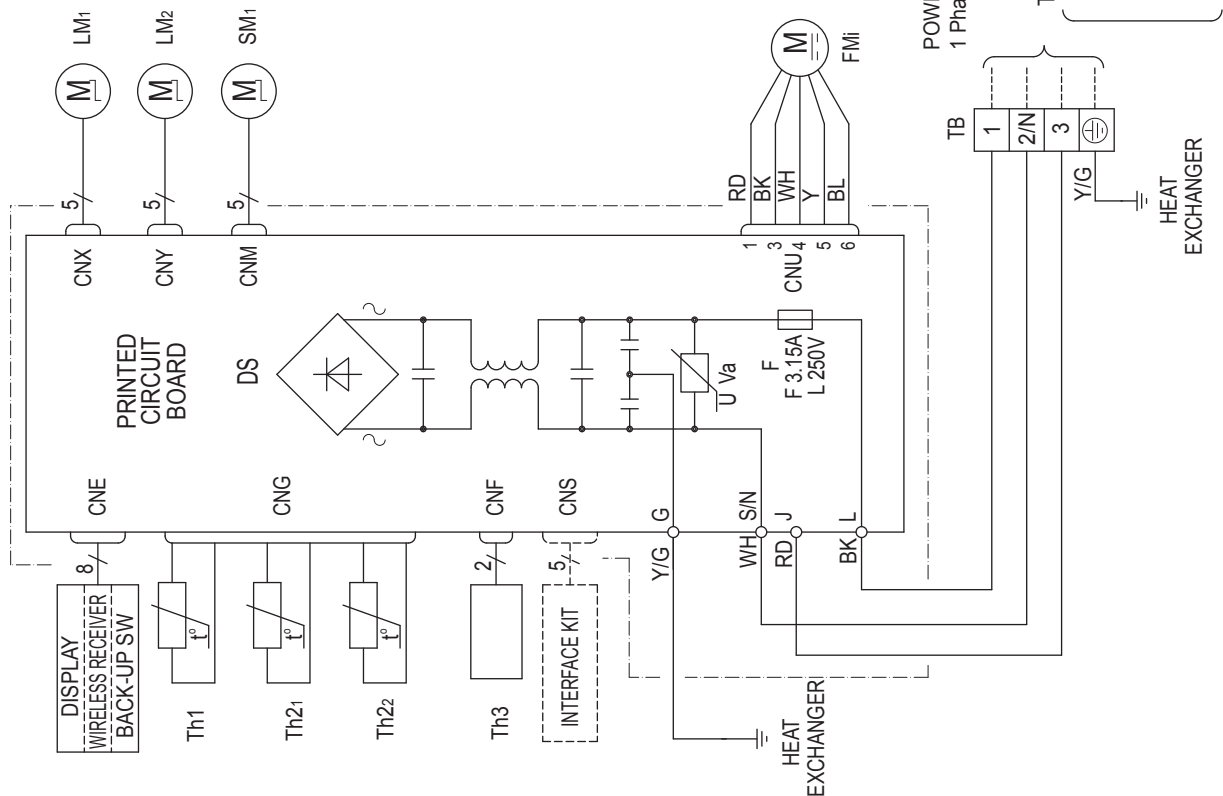

| Mark | Color |
|------|----------------|
| BK | Black |
| BL | Blue |
| RD | Red |
| WH | White |
| Y | Yellow |
| Y/G | Yellow / Green |

RWA000Z417

(b) Ceiling concealed type (SRR)

Models SRR25ZM-W, 35ZM-W, 50ZS-W, 60ZS-W

| Item | Description |
|--------------------|-----------------------------------|
| CNE | Connector |
| CNG | |
| CNS | |
| CNU | |
| CNW | |
| CNY | |
| FM _i | Fan motor |
| Th1 | Room temperature sensor |
| Th2 _{1,2} | Heat exchanger temperature sensor |
| DS | Diode stack |
| F _{1,2} | Fuse |
| TB | Terminal block |
| DM | Drain motor |
| FS | Float switch |
| Va | Varistor |

| Color Marks | Color |
|-------------|--------------|
| Mark | Color |
| BK | Black |
| BL | Blue |
| RD | Red |
| WH | White |
| Y | Yellow |
| Y/G | Yellow/Green |

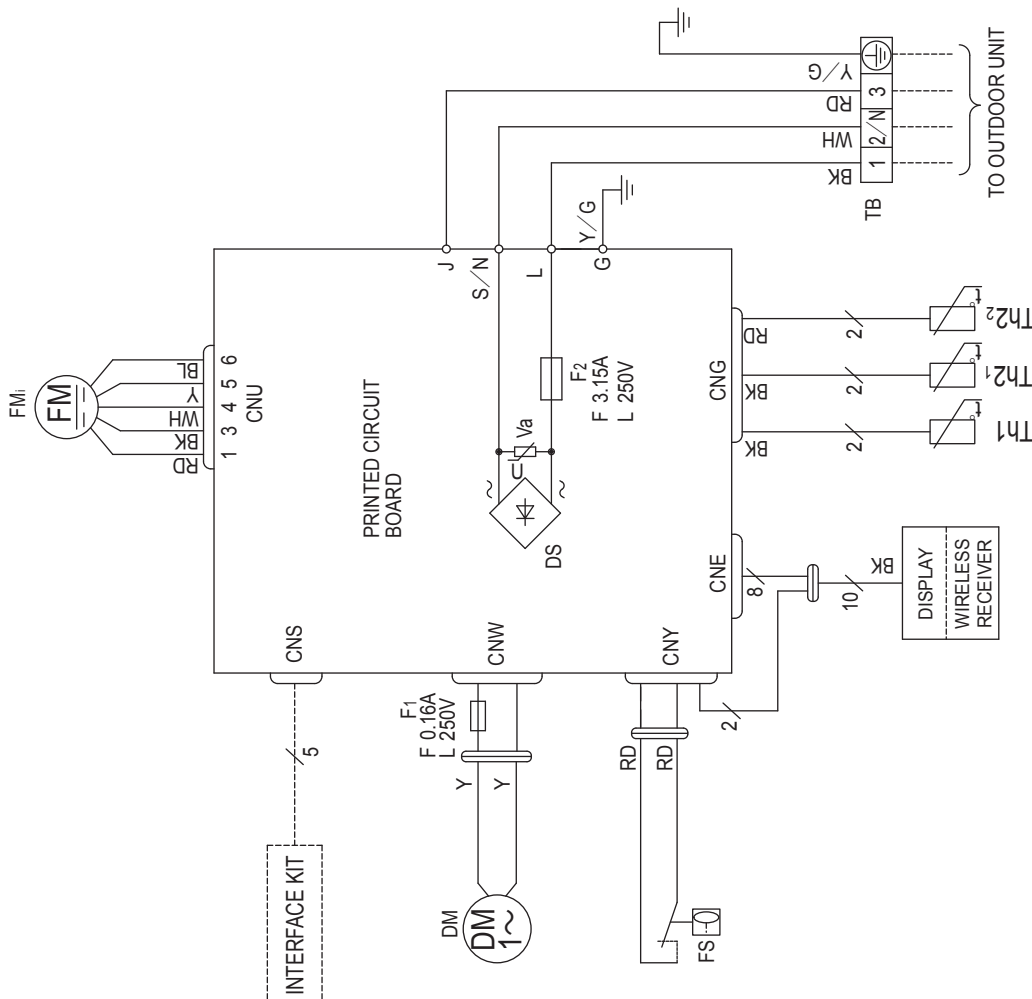

RJJ000Z003

(c) 4-way ceiling cassette type (FDTC)
Models FDTC25VH, 35VH, 50VH, 60VH

Meaning of marks

| Item | Description |
|------------|---|
| AM1 - 4 | Draft prevention function motor |
| CNB - Z | Connector |
| DM | Drain pump motor |
| F1,2 | Fuse |
| FMi | Fan motor |
| FS | Float switch |
| HS | Humidity sensor |
| LED•2 | Indication lamp (Green-Normal operation) |
| LED•3 | Indication lamp (Red-Inspection) |
| LM1-4 | Louver motor |
| PIS | Motion sensor |
| SW2 | Remote control communication address |
| SW5 | Plural units Master / Slave setting |
| SW6 | Model capacity setting |
| SW7-1 | Operation check drain pump motor test (run) |
| TB1 | Terminal block (Power source) (□mark) |
| TB2 | Terminal block (Signal line) (□mark) |
| ThC | Temperature sensor (Remote control) |
| Thi-A | Temperature sensor (Return air) |
| Thi-R1,2,3 | Temperature sensor (Heat exchanger) |

Color marks

| Mark | Color | Mark | Color |
|------|--------|-------|--------------|
| BK | Black | WH | White |
| BL | Blue | YE | Yellow |
| BR | Brown | GY | Gray |
| OR | Orange | YE/GN | Yellow/Green |
| RD | Red | | |

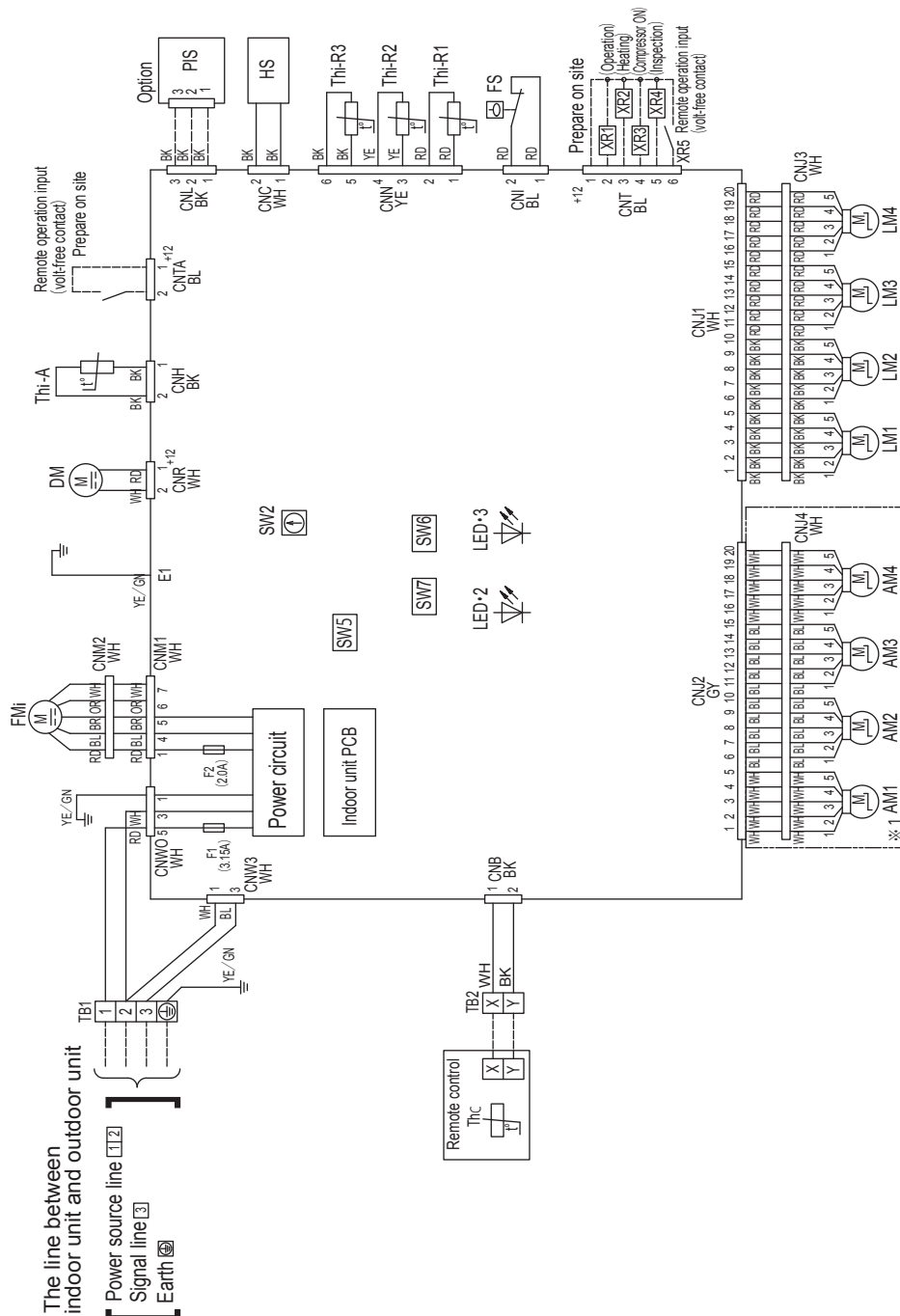

- Notes
1. --- indicates wiring on site.
 2. See the wiring diagram of outdoor unit about the line between indoor unit and outdoor unit.
 3. Use twin core cord (0.3mm²) at remote control line.
 4. See spec sheet of remote control in case that the total length is more than 100m.
 5. Do not put remote control line alongside power source line.
 6. Draft prevention function (※ 1) is provided on the panel TC-PSAE-5AW-E only.

(d) Duct connected-Low / Middle static pressure type (FDUM)
 Model FDUM50VH

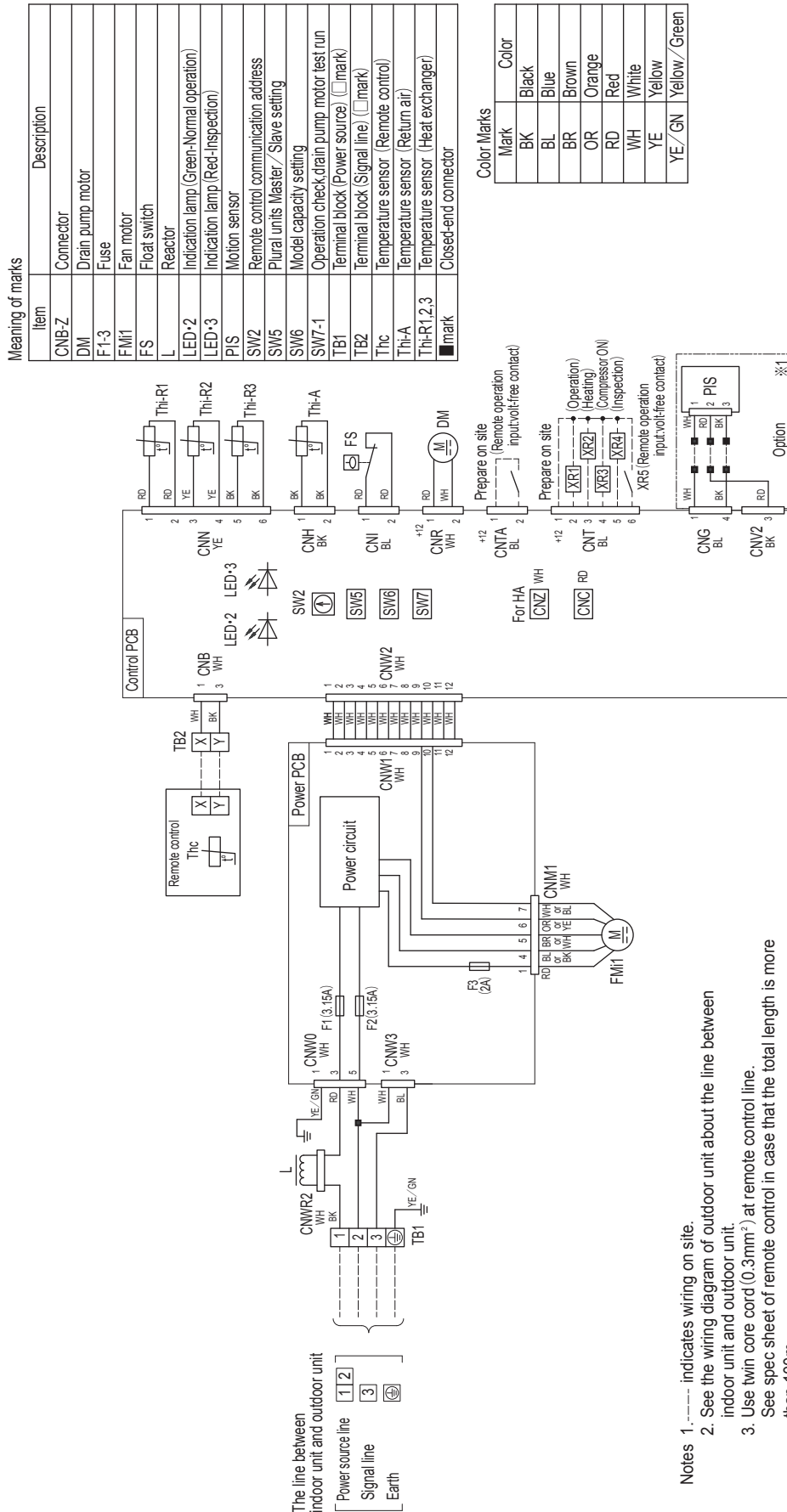

(e) Ceiling suspended type (FDE)
Model FDE50VH

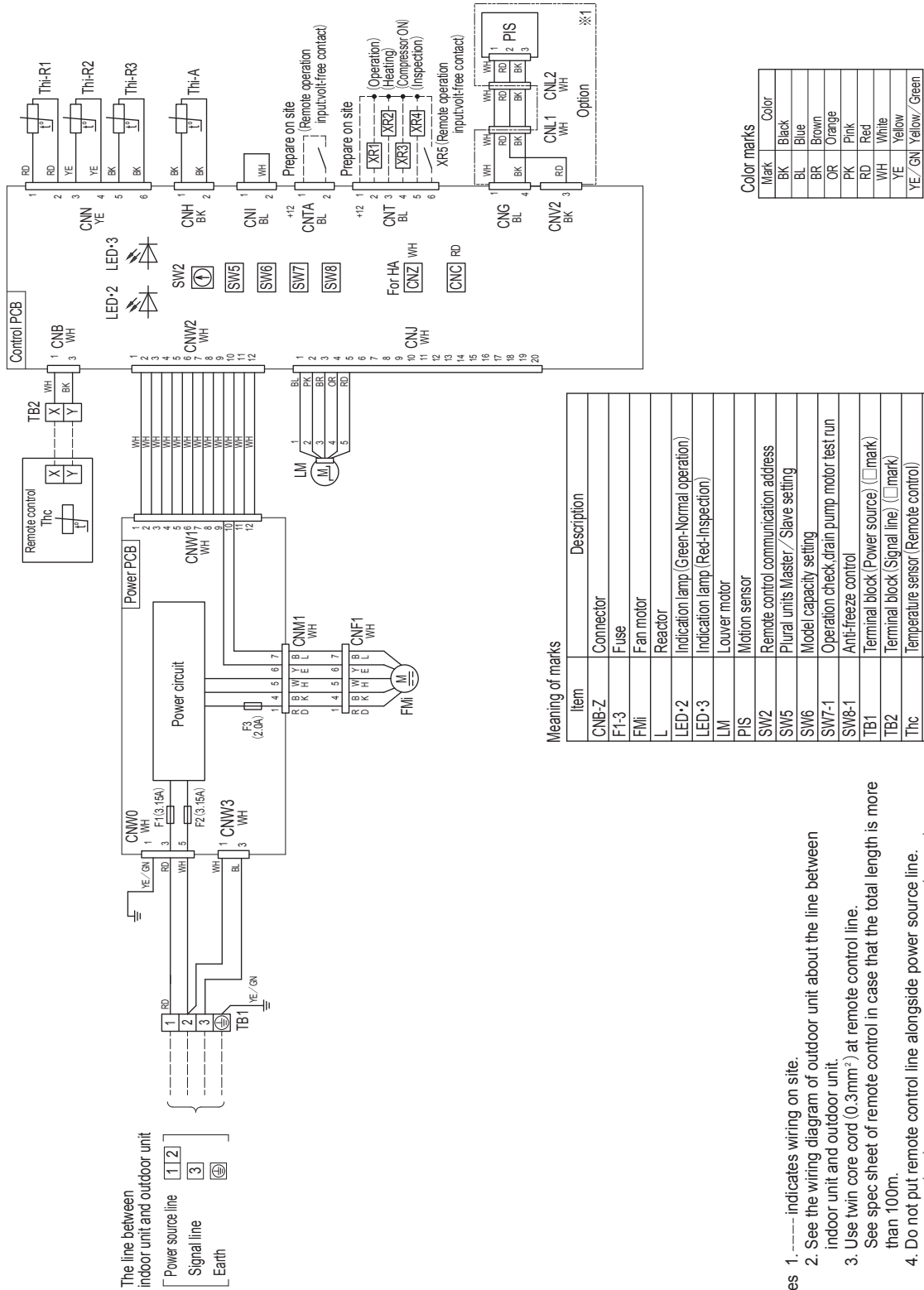

- Notes
1. --- indicates wiring on site.
 2. See the wiring diagram of outdoor unit about the line between indoor unit and outdoor unit.
 3. Use twin core cord (0.3mm²) at remote control line.
See spec sheet of remote control in case that the total length is more than 100m.
 4. Do not put remote control line alongside power source line.
 5. Section 1 (※1) shows electric circuit of motion sensor (Option).

4. PIPING SYSTEM

Models SCM71ZS-W, 80ZS-W

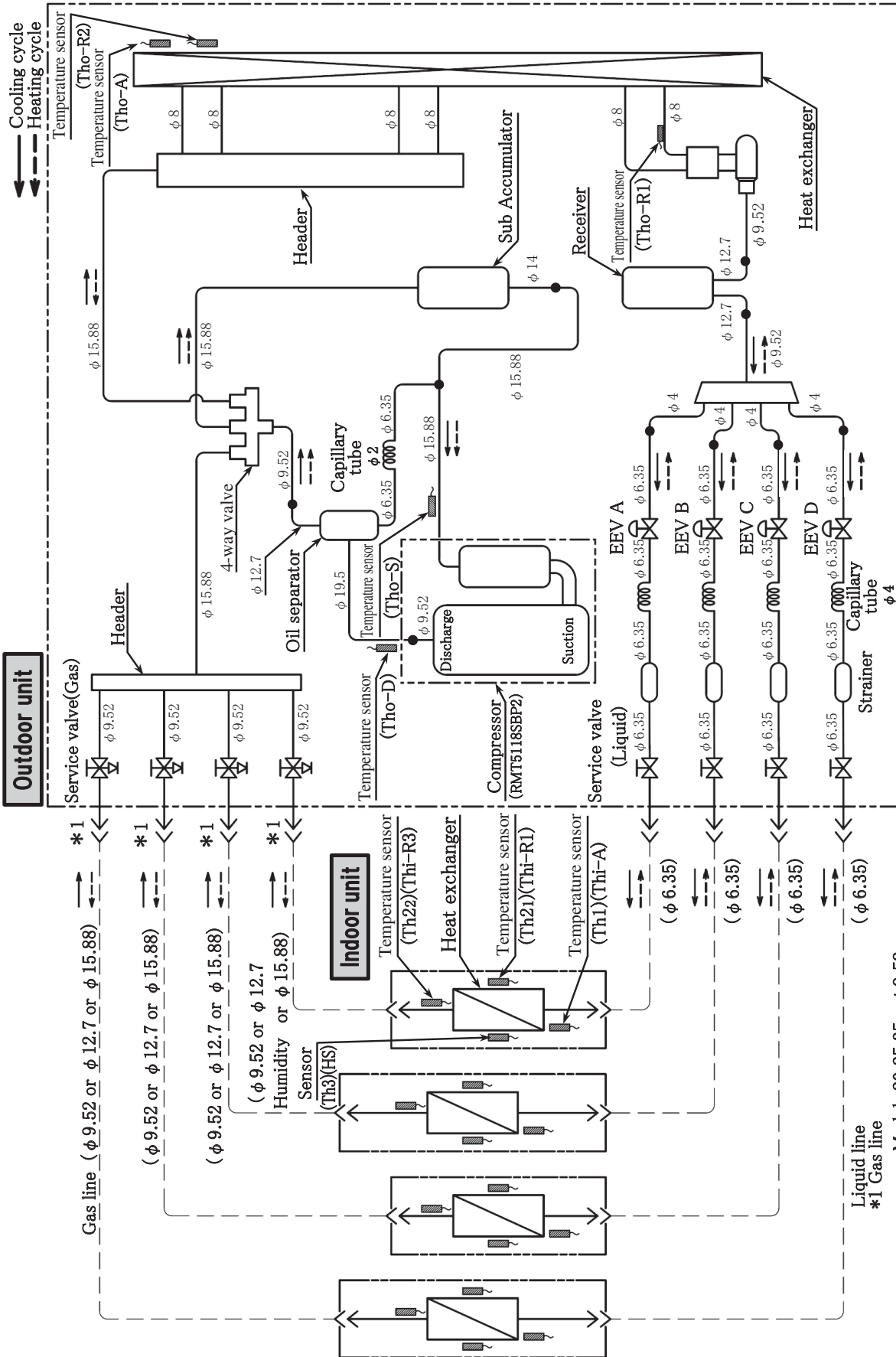

INVERTER MULTI-SPLIT SYSTEM RESIDENTIAL AIR-CONDITIONERS



MITSUBISHI HEAVY INDUSTRIES THERMAL SYSTEMS, LTD.

2-3, Marunouchi 3-chome, Chiyoda-ku, Tokyo, 100-8332, Japan

<http://www.mhi-mth.co.jp/en/>

Because of our policy of continuous improvement, we reserve the right to make changes in all specifications without notice.

© Copyright MITSUBISHI HEAVY INDUSTRIES THERMAL SYSTEMS, LTD.